

LINDNER

Das Original



Collectors Accessories of Distinction

COMPLETE CATALOG

English | Effective 01.01.2024

LINDNER

Das Original



Husband and wife partners Elena Lindner and Frank Wenger, owners and managing directors in 4th generation.



LINDNER Headquarter in Schömberg in the 50s.



Headquarter in Schömberg, Zollernalbkreis.

LINDNER at your service since 1947 - over 75 years of experience for the best possible storing solutions for collections worldwide.

THE TASK...

As a collector of stamps, coins, medals, banknotes and other objects you have taken on the rewarding task of safeguarding objects that may have monetary, personal or cultural significance. Through this you are documenting the present and the past in a very special format.

At LINDNER we have made it our primary mission to support you in your passion with our collecting systems. Whether your passion is to collect objects to preserve or enhance the value, or to research and develop a collecting theme, the presentation and storage of your collection is a fundamental part of your passion. The LINDNER product portfolio offers a wide range of possibilities and essential accessories to aid you in your hobby.

THE ESTABLISHMENT...

In 1947 August Lindner began to develop products for collectors and over the following years continued to expand these. What started as a small company with only a few products and co-workers has developed into a mid-sized global business with a considerable product range and variety; committed to unholding tradition and also innovating new ideas. The first coin album available in Germany is still a treasured LINDNER product to this very day. The hingeless (falzlos) system, the T-products and last but not least, the LINDNER coin boxes, are all inventions “Made by LINDNER” which have found their place in the world of collecting. The continual enhancing of the portfolio by working together with collectors and dealers a-like, has made LINDNER a household name in collector’s circles.

In 2006, just about 60 years after the company’s founding, the families 4th generation took over the management of the LINDNER business and is now leading this internationally established enterprise in its unchanged title. Our primary commitment is still offering high-quality, safe, beautiful and practical conservation of collector’s objects. Since its founding, the company’s headquarter is in Schömberg near Balingen in the Zollernalbkreis. Through a network of domestic and foreign dealers and distributors, we are represented nationally and internationally, enabling us to offer our products worldwide.

THE CLAIM...

Our principal goal to support you in your collector’s passion is assured through our high-quality standards. We see quality control in production and deliveries as a responsibility and self-evident. A large range of our products are still either self-produced or manufactured in German and European companies, which guarantees us a fast and efficient access to product and quality control. If nothing less, the quality standard of LINDNER is convincing worldwide in function, workmanship and design.

THE SERVICE...

Our high-quality standards of control extend themselves into our after sales service and our experienced advisory service. This applies equally for our advisory teams in our headquarter in Schömberg, as well as for our representatives worldwide. Through a long established collaboration with our sales partners we are now represented in 100 countries of the world.

CONTENTS

Coin supplies	2
Collecting accessories for banknotes	51
Stamp collecting	58
Other areas of collection	96-104
Optical accessories	105
Illustrated albums for stamps	113
Literature	128

Our **detailed index** can be found on the last page of our general catalog.

 Visit us on Facebook!
www.facebook.com/lindnerfalzlos/

LINDNER Falzlos-Gesellschaft mbH

Rottweiler Straße 38
D-72355 Schömberg
Postfach 11 63
D-72352 Schömberg

Telefon +49 (0) 74 27 / 70 10
Telefax +49 (0) 74 27 / 61 18

export@lindner-original.de
www.lindner-original.de

All prices and specifications are subject to change without prior notice. All products are offered without stamps, coins, or any other contents.

OUR MOST VALUABLE COLLECTION

Our employees are as varied as a collection of stamps. They make LINDNER a special company. They all have one common goal: Everyone gets involved every day in their respective area of responsibility and helps so significantly contribute to the success of our company. In today's time, which is characterized by constant change; teamwork, reliability and consistency are important requirements for continuous success. Our employees are the foundation for the success. Many are members of the LINDNER-family for decades.



LINDNER

Das Original



MADE IN GERMANY

LINDNER COIN BOXES

- representative, crystal clear, distortion-free
- stackable, non-skid base
- fits into a wide range of coin cases
- resistant velour insert available in two different shades of red, marine blue and black
- handy size: width 236 mm, depth 303 mm, height 20 mm (Coin Box), 30 mm (d-Box) and 40 mm (Collection Box)
- dimensions suitable for safes
- suitable to fit in most shelves and cabinets
- precise engineering of the synthetic frames enables a smooth sliding of the drawer

LINDNER COIN BOXES



The LINDNER coin boxes are easy to handle and the large selection provides flexibility for every coin collector. Coin collectors who already use the coin box system know that years of experience helped develop and improve this exceptional product line to satisfy the wishes of every coin collector and to provide individual storage solutions. Years ago, LINDNER developed the perfect coin box system with the help of coin specialists and coin collectors. **To ensure that you have purchased an original, high-quality LINDNER coin box, look for the "LINDNER" logo on the top of the tray pull handle.**

LINDNER coin boxes offer many possibilities and varieties for storage. **The unique stacking**

system allows you to select from 3 different heights of the boxes and from over 150 different configurations to hold small, large, thick and thin coins; as well as capsules and coin holders. Choose from different carrying cases to protect your coin or collection boxes.

The LINDNER coin box system can be expanded without limits. The boxes are stackable, sturdy, fit into most safes and match almost any decor. LINDNER offers a variety of practical accessories which – in combination with the coin boxes – provide a successful and safe storage solution for all your coins, medals and banknotes. All materials used in the manufacturing process of the LINDNER coin boxes have been subjected to

rigorous tests. The synthetic frame is scratch-resistant to ensure long-term usage and to maintain attractive appearance. LINDNER coin boxes are practical, versatile, safe and attractive!

The "Original"

"Original" only with LINDNER logo on tray pull handle.



STYLES

Standard

Grey drawer with light red velour insert and crystal clear frame.



Smoked glass

"Smoked glass" drawer with winered velour insert and crystal clear frame.



Marine

Grey drawer with dark blue velour inserts and crystal clear frame.



Carbo

Grey drawer with black velour inserts and crystal clear frame.



The red, winered, dark blue and black velour inserts create an ideal contrast to silver and gold coins, as well as medals. The crystal clear synthetic frame offers a clear view on your treasures. The high-quality velour inserts of our coin boxes are also available separately. This offers the possibility of "re-equipping" coin boxes or integrating the velour inserts into your own individual system. Format of the coin box inserts: 225 x 285 mm.

SIZES

Coin Box Height 20 mm

Width 236 mm, Depth 303 mm
(Page 4-9)



d-Box Height 30 mm

Width 236 mm, Depth 303 mm
(Page 10)



Collection Box Height 40 mm

Width 236 mm, Depth 303 mm
(Page 10, 96-97)



COIN BOXES WITH ROUND COMPARTMENTS FOR SINGLE COINS AND COIN SETS

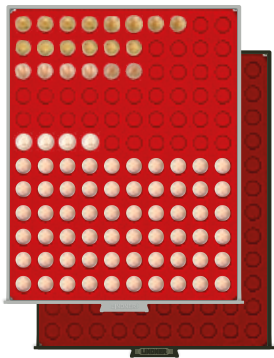

Ø 16.5 mm 120x
 ● 2501 ● 2901
 1 €-Cent, 1 Pfennig, 1 Rappen, 1/10 Oz American Eagle / Britannia / Kangaroo / Krugerrand / Libertad / Maple Leaf / Vienna Philharmonic (gold), 1/10 Oz Britannia / Libertad (silver)

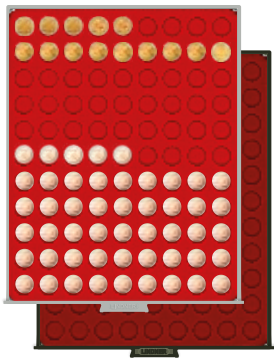

Ø 19.25 mm 99x
 ● 2502 ● 2902
 2 €-Cent, 2 Pfennig, 5 Marks Kaiserreich (gold), 20 € "Deutscher Wald" (gold), 10 Crowns Austria (gold), 10 Rappen, 10 Vreneli CHF (gold), 1/10 Oz Lunar II / Panda (gold)

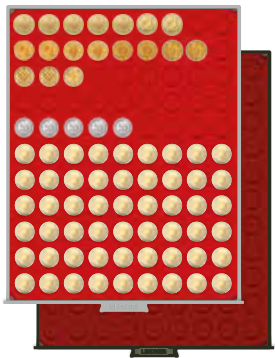

Ø 20.0 mm 99x
 ● 2550 ● 2950
 10 €-Cent, 50 Pfennig, 10 Marks Kaiserreich (gold), 1/4 Oz "Luther Rose" 50 € (gold), 2 Rappen, 1/4 Oz Maple Leaf (gold), 1/10 Oz Libertad (silver)

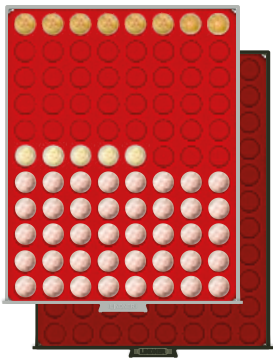

Ø 21.5 mm 88x
 ● 2510 ● 2910
 5 €-Cent, 10 Pfennig, 20 Rappen, 20 Vreneli CHF (gold), 1/4 Oz Kangaroo (gold), 1/10 Oz Koala (silver)

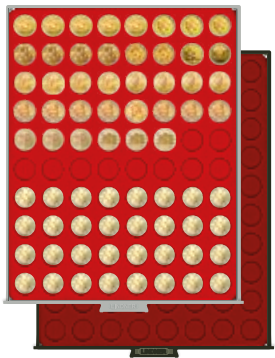

Ø 22.25 mm 80x
 ● 2580 ● 2980
 20 €-Cent, 1 Pound Great Britain (gold), 1/4 Oz France (gold), 1/4 Oz American Eagle / Britannia / Panda / Krugerrand / Queen's Beasts / Vienna Philharmonic (gold), 1/4 Oz Britannia (silver)

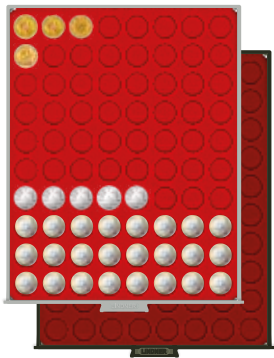

Ø 23.5 mm 80x
 ● 2108 ● 2708
 1 €, 1 DM, 1 DM (gold), 20 Marks Kaiserreich (gold), 5 Austrian shillings, 1 CHF, 1 Franc (silver), 1/4 Oz Libertad / Lunar II (gold)

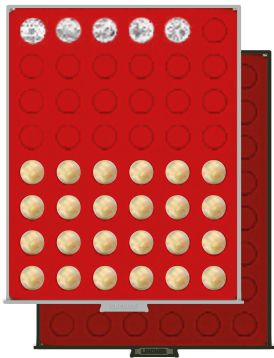

Ø 24.25 mm 48x
 ● 2549 ● 2949
 50 €-Cent, 1 Marks Kaiserreich (silver), 25 Cent (USA, State Quarters)

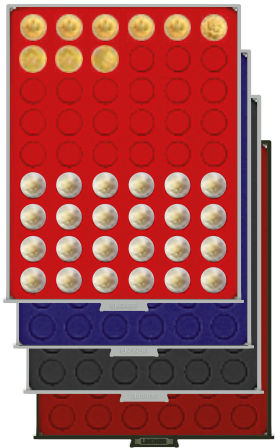

Ø 25.75 mm 54x
 ● 2154 ● 2154M
 ● 2754 ● 2154C
 2 €, 10 Francs from 1974, 1/2 Oz Maple Leaf / Kangaroo (gold)

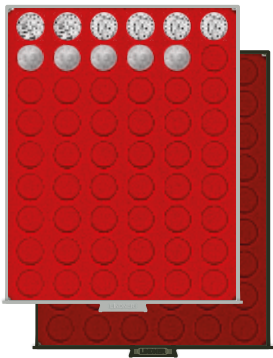

Ø 26.75 mm 54x
 ● 2109 ● 2709
 2 DM, 2 Reichsmark (Ag/Cu), 50 Kopeek Nicholas II, 1895-1914 (silver)

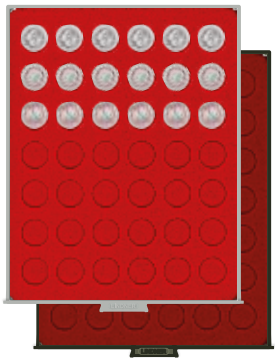

Ø 27.5 mm 42x
 ● 2107 ● 2707
 5 € Germany, 50 Austrian shillings (Bi-Metall), 2 CHF, 1/2 Oz American Eagle / Britannia / Krugerrand / Panda (gold), 1/4 Oz Libertad (silver), 1/2 Oz Britannia (silver)

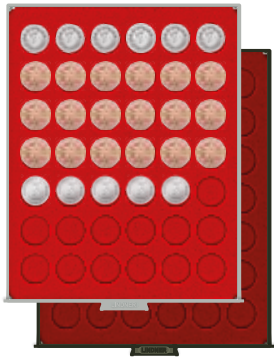

Ø 29.5 mm 42x
 ● 2105 ● 2705
 10 € Polymer Germany, 100 € Germany (gold), 5 DM, 2 Marks Kaiserreich (silver), 5 € Austria (silver), 50 Francs (gold), 5 Francs from 1960 (silver), 1/2 Oz Libertad / Vienna Philharmonic (gold)



Ø 31.0 mm 35x
 ● 2104 ● 2704
 3 Reichsmark (Ag/Cu), 10 DM (DDR), 25 Austrian shillings, 5 CHF, 100 Francs (silver), 1/2 Oz France (gold), 1 Roubels (Russia), 1/2 Oz Lunar II (gold), 1 Oz Maple Leaf (gold)

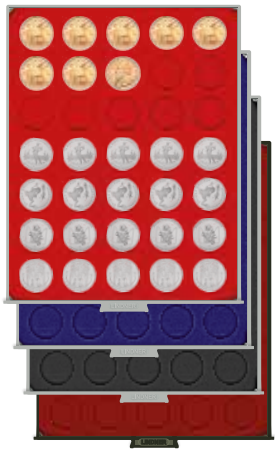

Ø 32.5 mm 35x
 ● 2111 ● 2111M
 ● 2711 ● 2111C
 10 € / 20 € Silver Germany, 1 Oz 200 € Germany (gold), 10 DM, 1 Oz American Buffalo / American Eagle / Britannia / Kangaroo / Krugerrand / Niue Turtle / Panda / Queen's Beasts (gold)



Ø 32.5 mm 24x
 ● 2110
 10 € / 20 € Silver Germany, 1 Oz 200 € Germany (gold), 10 DM, 1 Oz American Buffalo / American Eagle / Britannia / Kangaroo / Krugerrand / Niue Turtle / Panda / Queen's Beasts (gold)



Ø 34 mm 30x
 ● 2150 ● 2750
 Médailles Souvenirs, 3 Marks Kaiserreich (silver), 20 € France (silver), 20 CHF, 3 € Tiertaler Austria, 100 Austrian shillings (gold), 5 Roubels Olympia (silver), 1/2 Oz Libertad / Maple Leaf / Panda (silver)

LINDNER coin boxes, d-boxes and collection boxes can be mixed and stacked on top of each other. Only the height of each box is different!

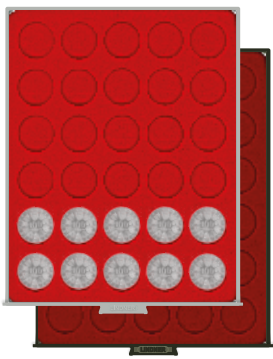

Ø 36.0 mm 30x

● 2101 ● 2701

5 Reichsmark (Ag/Cu),
100 Austrian shillings,
1/2 Oz Koala / Lunar II (silver)



Ø 37.0 mm 30x

● 2161 ● 2761

10 € France (silver),
5 Francs until 1889 (silver),
1 Oz Vienna Philharmonic (gold),
1/2 Oz Koala (silver),
1 Oz Vienna Philharmonic (silver)

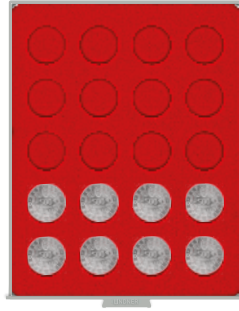

Ø 38.0 mm 20x

● 2102

5 Marks Kaiserreich (silver),
500 Austrian shillings, 1 Oz Maple
Leaf / Canadian Wildlife (silver)

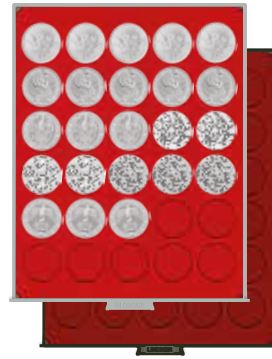

Ø 39.0 mm 30x

● 2106 ● 2706

3 Roubels commemorative coin
(silver), 10 Roubels Olympia (silver),
1 Oz Lunar II (gold), 1 Oz Krugerrand
/ Maple Leaf (silver), 2 Oz Queen's
Beasts (silver)

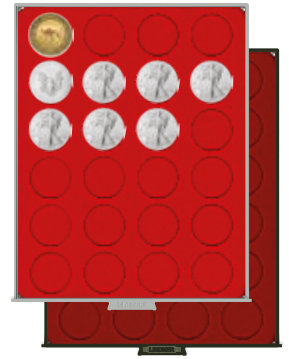

Ø 41.0 mm 24x

● 2160 ● 2760

50 € France (silver), 2 Oz Kangaroo
/ Lunar II (gold), 1 Oz American
Eagle / Britannia / Niue Turtle /
Kangaroo / Koala / Kokkaborra /
Libertad (silver), 2 Oz Niue Turtle
(silver)

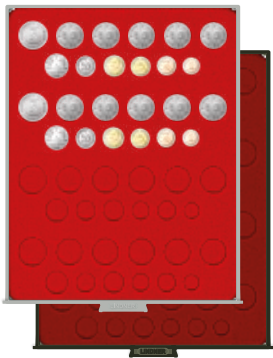

48 Compartments

● 2204 ● 2604

4x German Mark Coin set

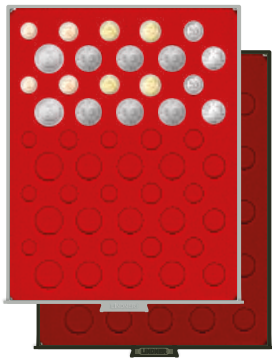

50 Compartments

● 2207 ● 2607

5x German Mark Coin set

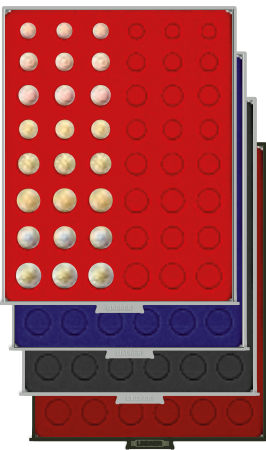

48 Compartments

● 2506 ● 2506M

● 2906 ● 2506C
6x €-Coin set

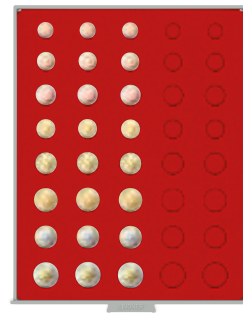

40 Compartments

● 2555

5x €-Coin set

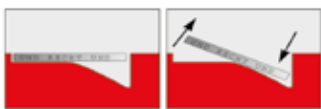
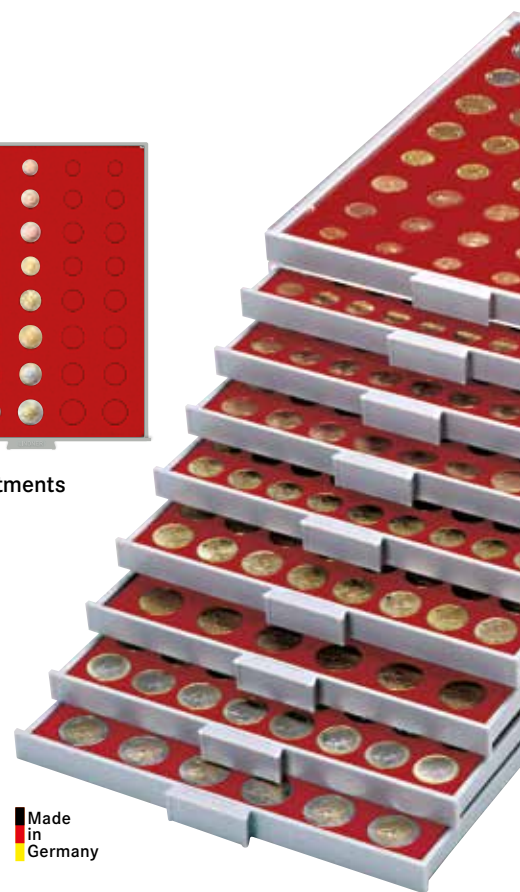

LINDNER - Coin box recess:
Simply press on the back half of
the coin and it will lift at the front;
then remove it with ease.

Format:
236 x 303 x 20 mm

Made
in
Germany

COIN BOXES FOR EURO COINS



1 Cent	2 Cent	5 Cent	10 Cent	20 Cent	50 Cent	1 Euro	2 Euro	5 Euro	10 Euro polymer ring	10 Euro 20 Euro	● 2506 ● 2906 ● 2506M ● 2506C
● 2501	● 2502	● 2510	● 2550	● 2580	● 2549	● 2108	● 2154	● 2107	● 2105	● 2111	
● 2901	● 2902	● 2910	● 2950	● 2980	● 2949	● 2708	● 2754	● 2707	● 2705	● 2711	
							● 2154M			● 2111M	
							● 2154C			● 2111C	

LINDNER coin boxes, d-boxes and collection boxes can be mixed and stacked on top of each other. Only the height of each box is different!

COIN BOXES WITH ROUND COMPARTMENTS FOR SINGLE COINS AND COIN SETS IN COIN CAPSULES

				
<p>Ø 24.0 mm 48x</p> <p>● 2524 ● 2924</p> <p>☉ 2250018P</p> <p>1 €-Cent, 1/10 Oz Libertad / Maple Leaf / Vienna Philharmonic (gold), 1/10 Oz Libertad (silver), 1/10 Oz American Eagle / Britannia / Kangaroo / Krugerrand (gold), 1/10 Oz Britannia (silver), 20 € "Deutscher Wald" (gold), 5 Marks Kaiserreich (gold), 5 Rappen</p>	<p>Ø 26.0 mm 48x</p> <p>● 2548 ● 2948</p> <p>☉ 2250020P</p> <p>10 €-Cent, 2 Pfennig, 10 Marks Kaiserreich (gold), 10 Crowns Austria (gold), 10 Rappen, 10 Vreneli CHF (gold)</p>	<p>Ø 29.5 mm 42x</p> <p>● 2529 ● 2929</p> <p>☉ 2250023P</p> <p>20 Marks Kaiserreich (gold), 1/4 Oz Lunar II (gold), 1 Franc (silver)</p>	<p>Ø 32.0 mm 35x</p> <p>● 2530 ● 2530M ● 2930 ● 2530C</p> <p>☉ 2250026P</p> <p>2 €, 10 Francs ab 1974, 1/2 Oz Kangaroo / Maple Leaf (gold), 1/4 Oz Panda (silver)</p>	<p>Ø 34.0 mm 35x</p> <p>● 2535 ● 2935</p> <p>☉ 2250275P ☉ 2250028P</p> <p>5 € Germany, 1/2 Oz American Eagle / Britannia / Krugerrand / Panda (gold), 1/4 Oz Libertad (silver), 1/2 Oz Britannia (silver), 50 Austrian shillings, 1996-2001 (Bi-metal), 20 Austrian shillings, 2 CHF, 50 Francs (gold)</p>
				
<p>Ø 36.0 mm 35x</p> <p>● 2225 ● 2625</p> <p>☉ 2250029P ☉ 2250295P ☉ 2250030P</p> <p>10 € Polymer Germany, 100 € commemorative coin Germany (gold), 2 Marks Kaiserreich (silver), 5 Francs from 1960 (silver), 1/2 Oz Vienna Philharmonic (gold), 2 Austrian shillings</p>	<p>Ø 37.5 mm 30x</p> <p>● 2537 ● 2537M ● 2937 ● 2537C</p> <p>☉ 2260325P</p> <p>10 €/20 € Silver Germany (Special Capsule: Same as the original capsule 10 €/20 € proof silver coins Germany)</p>	<p>Ø 39.5 mm 30x</p> <p>● 2226 ● 2226M ● 2626 ● 2226C</p> <p>☉ 2250325P ☉ 2250033P</p> <p>10 €/20 € Silver Germany, 10 DM, 200 € gold coin, 1 Oz Niue Turtle (gold), 1 Oz American Buffalo / American Eagle / Britannia / Kangaroo / Krugerrand / Queen's Beasts (gold)</p>	<p>Ø 41.0 mm 24x</p> <p>● 2224 ● 2624</p> <p>☉ 2250035P</p> <p>20 US \$ Liberty (gold), 20 Francs (1929-1939), 100 Francs (gold), 1 Oz Libertad (gold)</p>	<p>Ø 42.0 mm 20x</p> <p>● 2103 ● 2703</p> <p>☉ 2250036P</p> <p>100 Austrian shillings (silver)</p>

COIN BOXES FOR EURO COINS IN COIN CAPSULES

												
1 Cent	2 Cent	5 Cent	10 Cent	20 Cent	50 Cent	1 Euro	2 Euro	5 Euro	10 Euro polymer ring	10/20 Euro		
☉ 2250165P	☉ 2250019P	☉ 2250215P	☉ 2250020P	☉ 2250225P	☉ 2250245P	☉ 2250235P	☉ 2250026P	☉ 2250275P	☉ 2250029P	☉ 2260325P	☉ 2250E	
● 2524	● 2548	● 2529	● 2548	● 2529	● 2530	● 2529	● 2530	● 2535	● 2225	● 2537	● 2556	
● 2924	● 2948	● 2929	● 2948	● 2929	● 2930	● 2929	● 2930	● 2935	● 2625	● 2937	● 2956	
					● 2530M		● 2530M			● 2537M	● 2556M	
					● 2530C		● 2530C			● 2537C	● 2556C	

LINDNER coin boxes, d-boxes and collection boxes can be mixed and stacked on top of each other. Only the height of each box is different!



Ø 44.0 mm 20x

● 2544 ● 2944

○ 2250038P

1 Oz Vienna Philharmonic (gold),
1 Oz Vienna Philharmonic (silver)

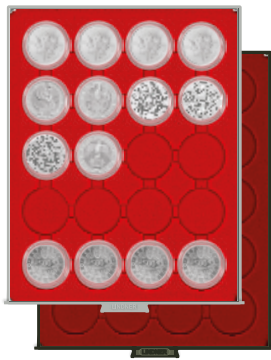

Ø 46.0 mm 20x

● 2220 ● 2620

○ 2230P

○ 2630P

○ 2250039P

○ 2250040P

○ S2255384P

1 Oz Krugerrand (silver),
1 Oz BIG FIVE, South Africa (silver),
1 Oz Lunar II (gold), 10 Roubels
Olympia (silver) 1 1/2 Oz Canadian
Wildlife Polarbear / Polarfox (silver),
1 1/4 Oz Canadian Wildlife Bison
(silver)



Ø 48.0 mm 20x

● 2520 ● 2920

○ 2250041P

○ 2250042P

1 Silver Dollar, 2 Oz Kangaroo (gold),
1 Oz American Eagle / Kangaroo /
Koala / Kookaburra / Panda (silver),
50 € France (silver), 2 Oz Lunar II
(gold)

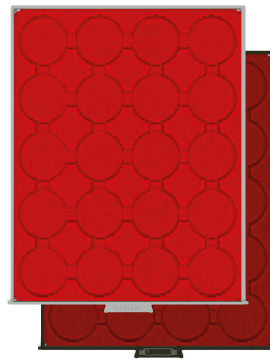

Ø 49.0 mm 20x

● 2543 ● 2943

○ 2250043P



Ø 51.0 mm 15x

● 2515 ● 2915

○ 2250045P

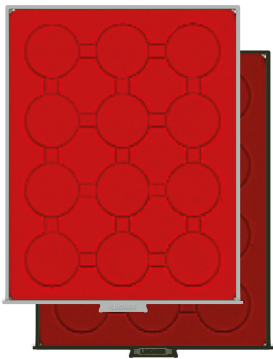

Ø 54.0 mm 12x

● 2554 ● 2954

○ 2250048P

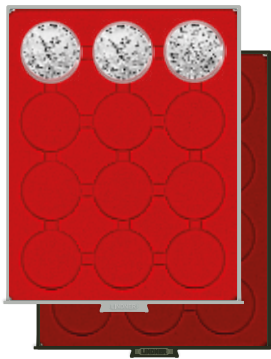

Ø 58.0 mm 12x

● 2212 ● 2612

○ 2231P

○ 2631P



40 Compartments

● 2556 ● 2556M

● 2956 ● 2556C

○ 2250E

5x €-Coin set



**COIN BOX
BLACK SAMT**



Ø 34.0 mm 30x

● S2533-2K

● S2933-2K

Incl. 30 coin capsules



**Format:
236 x 303 x 20 mm**

Made
in
Germany

Coin capsules
see page 12-13.



Coin box carrying cases
see page 22.



LINDNER coin boxes, d-boxes and collection boxes can be mixed and stacked on top of each other. Only the height of each box is different!

COIN BOXES WITH SQUARE COMPARTMENTS

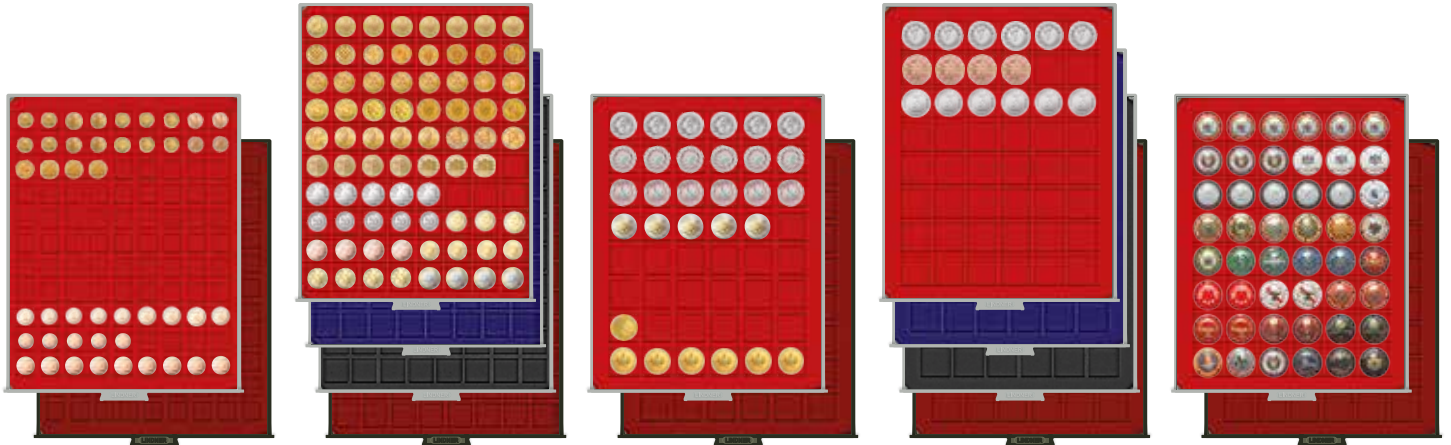

19.0 mm 99x
 ● 2199 ● 2799
 2 €-Cent, 5 Pfennig, 10 Rappen, 10 Crowns Austria (gold), 10 Vreneli SFR (gold), 1/10 Oz Lunar II (gold)

24.0 mm 80x
 ● 2180 ● 2180M
 ● 2780 ● 2180C
 1 DM, 1 DM (gold), 1 Marks Kaiserreich (silver), 5 Austrian schillings

28.0 mm 48x
 ● 2149 ● 2749
 5 € Germany, 100 € commemorative coin Germany (gold), 2 Marks Kaiserreich (silver), 20 Austrian schillings, 50 Francs (gold), 1/2 Oz Vienna Philharmonic (gold)

30.0 mm 48x
 ● 2148 ● 2148M
 ● 2748 ● 2148C
 10 € Polymer Germany, 5 DM, 5 € Austria (silver), 1/2 Oz Libertad (gold), 1 Oz Maple Leaf (gold)

30.0 mm 48x
 ● 2148F ● 2748F
 Campagne lids (Compartments less deep)



36.0 mm 35x
 ● 2135 ● 2135M
 ● 2735 ● 2135C
 Médailles Souvenirs, 5 Reichsmark (Ag/Cu), 100 Austrian schillings (gold), 100 Vreneli SFR (gold), 100 Francs (gold), 1/2 Oz Lunar II / Maple Leaf / Panda (silver)

38.0 mm 30x
 ● 2115 ● 2115M
 ● 2715 ● 2115C
 5 Marks Kaiserreich (silver), 500 Austrian schillings, 10 € France (silver), 1 Oz Canadian Wildlife / Maple Leaf / Vienna Philharmonic (silver), 1 Oz Vienna Philharmonic (gold)

42.0 mm 24x
 ● 2124 ● 2124M
 ● 2724 ● 2124C
 50 € France (silver), 2 Oz Lunar II (gold), 1 Oz American Eagle / Kangaroo / Koala / Kokkaburra (silver), 2 Oz Niue Turtle (silver)

47.0 mm 20x
 ● 2120 ● 2120M
 ● 2720 ● 2120C
 100 € France (silver), 1 Oz Lunar II (silver)

50.0 mm 20x
 ● 2122 ● 2122M
 ● 2722 ● 2122C
 OCTOS, CARRÉE, Coin holders 50 x 50 mm, 5 Oz France (silver), 2 Oz Libertad (silver)



51.0 mm 20x
 ● 2221 ● 2621
 Coin box inserts, 2 Oz Kokkaburra (silver) in original capsules, 5 Oz France (silver), 2 Oz Libertad (silver)

51.0 mm 20x
 ● 2121 ● 2721
 Compartments a little deeper, e.g. suitable for all common silver coins 1 and 2 ounces (Oz), also in Coin capsules



66.0 mm 12x
 ● 2112 ● 2712
 5 Oz Panda (gold), 2 Oz Kokkaburra / Lunar II (silver), 5 Oz Niue Turtle (silver)

68.0 mm 12x
 ● 2213 ● 2613
 Encapsulated coins, Coin box inserts, Coin holders 67 x 67 mm

24 mm, 28 mm, 39 mm, 44 mm / 45 compartments
 ● 2145 ● 2145M
 ● 2745 ● 2145C

LINDNER coin boxes, d-boxes and collection boxes can be mixed and stacked on top of each other. Only the height of each box is different!

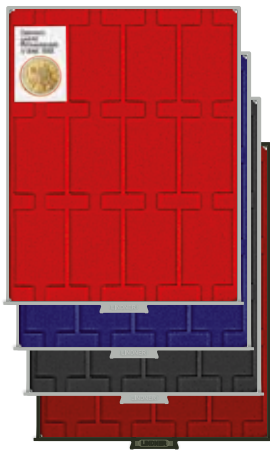
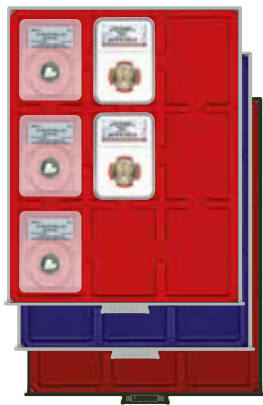
COIN BOXES WITH RECTANGULAR COMPARTMENTS

				
57 x 50 mm / 12x ● 2605 5 DM commemorative coins originally sealed in blister (PP)	50 x 75 mm / 12x ● 2170 ● 2170M ● 2770 ● 2170C REBECK COIN L Coin holders	63 x 85 mm / 9x ● 2219 ● 2219M ● 2619 Slabs (original US coin capsules)	150 x 150 mm ● 2211 ● 2611 Originally sealed 10 DM commemorative coins (PP) with all 5 mint initials	210 x 270 mm ● 2100 ● 2700 One large compartment

COIN BOX BLACK SAMT

	
27 x 47 mm / 20x ● S2533-4 ● S2933-4 without coin capsules	27 x 47 mm / 20x ● S2533-4K ● S2933-4K incl. 20 coin capsules

 Suitable rectangular coin capsules (S22552747P) see page 13.

Format:
236 x 303 x 20 mm

 Made in Germany



ACCESSORY KIT

Contains 4 non-skid snap-on buttons for the bottom of a coin box or collection box and 1x LINDNER Schildfix.

€ 2185

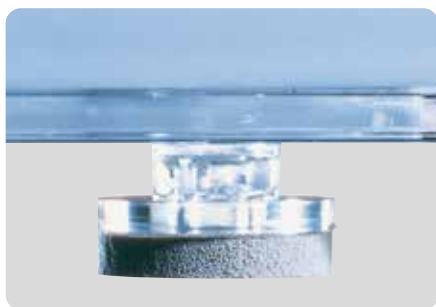

LINDNER SCHILDFIX

LINDNER Schildfix for an easy and individual labelling of coin boxes, d-boxes and collection boxes. Content: 5 self-adhesive transparent strips, length 90 mm and 10 white pre-cut labels for inserting descriptions.

€ 2188



COIN BOX DISPLAY MADE OF ACRYLIC GLASS

The coin boxes can be displayed horizontally (inclination approx. 75°) as well as vertically (inclination approx. 20°).

€ 2187



LINDNER coin boxes, d-boxes and collection boxes can be mixed and stacked on top of each other. Only the height of each box is different!

D-BOXES

HEIGHT 30 mm – SPACE FOR THE "LARGE" AND THE "THICK"

The LINDNER d-box offers more options for the coin and medal collector. The drawer has a height of 22 mm to store and protect especially large and thick coins. LINDNER coin boxes, d-boxes and collection boxes can be mixed and stacked on top of each other. Only the height of each box is different!

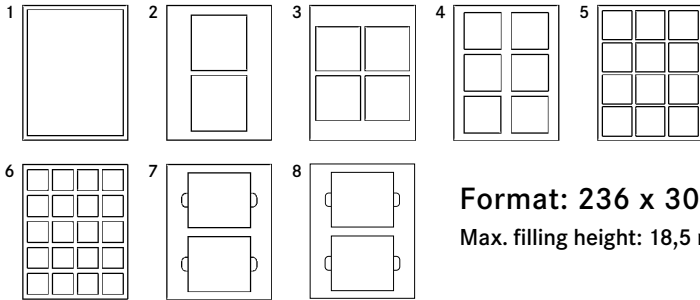

Format: 236 x 303 x 30 mm
Max. filling height: 18,5 mm

No.		Quantity of compartments	Standard	Smoked glass	SUITABLE FOR:
1	210 x 270 mm	1	2800	2850	Medals, extra large or thick coins. The d-boxes 2, 3 and 4 are also ideal for the €-starter-kits (see ill.)
2	125 x 125 mm	2	2802	2852	
3	100 x 100 mm	4	2804	---	
4	85 x 85 mm	6	2806	2856	
5	66 x 66 mm	12	2812	2862	
6	47 x 47 mm	20	2820	2870	
7	140 x 123 mm	2	2805	2855	2x 5 original, uncirculated € coin sets 2002-2014, Germany
8	152 x 123 mm	2	2803	---	20 € Silver coins in original presentation folder, original, uncirculated € coin sets Germany 2015 and up: 2x 5 in mint state or 2x 2 in proof-like quality



COLLECTION BOX

HEIGHT 40 mm – EXTRA ROOM FOR COLLECTORS SPECIAL WISHES!

1 Collection Box »Eplalux«

Two rectangular compartments hold a maximum of 24 mint sets of coins issued by the German Federal Bank.

Size: 170 x 107 mm.

☞ 2408 Standard

☞ 2468 Smoked glass

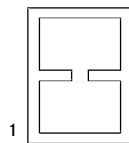

2 Collection Box »Eplalux«

Holds up to 12 "Eplalux" cases (proof sets of the German Federal Bank) in three rectangular compartments.

Size: 160 x 100 mm.

☞ 2407 Standard

☞ 2467 Smoked glass

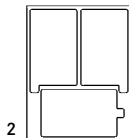

Format: 236 x 303 x 40 mm
Max. filling height: 29 mm



LINDNER coin boxes, d-boxes and collection boxes can be mixed and stacked on top of each other. Only the height of each box is different!



An extensive description of the LINDNER collection box system and all its possibilities are found on pages 96-97. Fitting cases on page 22.







COIN BOX CAPSULES FOR COINS Ø 16 - 51 mm



More safety and flexibility with coin box capsules: Additional protection for all your coins against environmental influences, fingerprints, dirt, skin oil and moisture! Two capsule sizes offer maximum flexibility by holding coins from Ø 16 up to 51 mm. Every capsule contains a red insert consisting of several concentric rings. The number

of rings of the inserts can be adjusted to accommodate the coin. Multiple coin sizes can be kept in one coin box. The capsules come in red or winered, matching the velour insert of our "Standard" or "Smoked glass" coin boxes.

Material rings: PP polypropylene



			
1	 2230P	Coin box capsules, small External Ø 46 mm	Ø 16 - 39 mm
	 2630P		
2	 2231P	Coin box capsules, large External Ø 58 mm	Ø 16 - 51 mm
	 2631P		

MATCHING COIN BOX:		Quantity of compartments
		
2220	2620	20
2212	2612	12

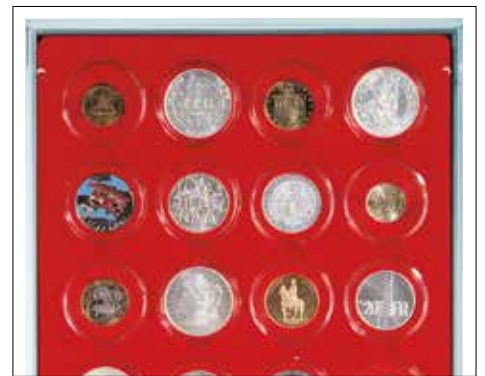
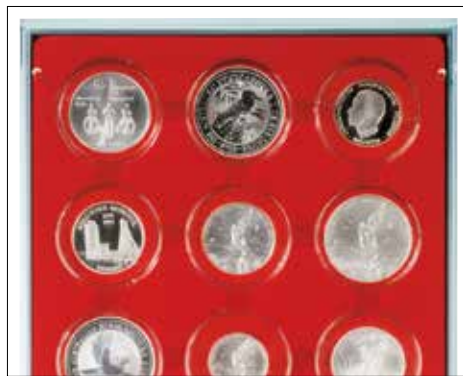
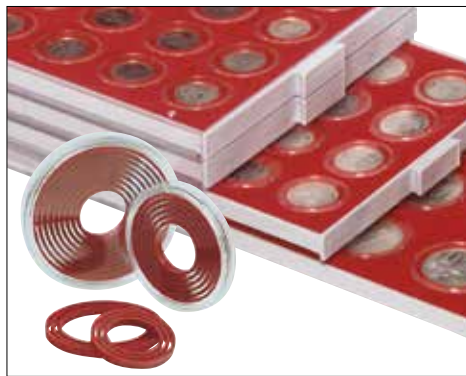







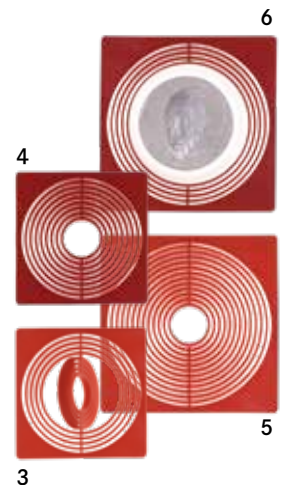

COIN BOX INSERTS FOR COINS OR CAPSULES UP TO Ø 62 mm



Small coins, large coins, encapsulated coins and coins without coin capsules – you can collect almost limitless with our coin box inserts. Just two coin box variations but countless possibilities because: Inlets in two different sizes offer a maximum of flexibility and accuracy up to a diameter of 62 mm. The usage is very simple. Just lay the coin or the coin capsule on top of the inserts. Now you have to

break out the excess rings. So if you like to collect very different sizes of coins or coin capsules in one coin box, get with this the perfect system. LINDNER coin box inserts are available in red and winered, suitable for the coin boxes "Standard" and "Smoked glass".

Material: PP polypropylene



			
3	 2236	Coin box inserts, small 51 x 51 mm	until Ø 45 mm
4	 2636		
5	 2237	Coin box inserts, large 68 x 68 mm	until Ø 62 mm
6	 2637		

MATCHING COIN BOX:		Quantity of compartments
		
2221	2621	20
2213	2613	12

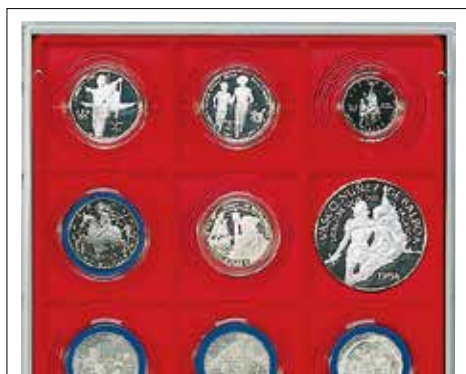

COIN CAPSULES

FOR COINS Ø 14 - 34,5 mm

Choose coin capsules for your valuable coin collection. The special scratch-resistant surface offers maximum protection as well as a "crystal clear" view of the coin.

Special production from 10.000 pieces.



					SUITED FOR:	MATCHING COIN BOX				Compartments
14 mm	20 mm	2,4 mm	2250014P	2251014	1/25 Oz Vienna Philharmonic (gold), 1/20 Oz Libertad / Panda (gold)					
15 mm	21 mm	2,45 mm	2250015P	2251015	1/20 Oz Lunar II / Maple Leaf / Kangaroo (gold)					
16 mm	22 mm	2,45 mm	2250016P	2251016						
16,5 mm	22,5 mm	2,55 mm	2250165P	2251165	1 €-Cent, 1/10 Oz Libertad / Maple Leaf / Vienna Philharmonic (gold), 1/10 Oz Libertad (silver)	2524	2924	---	---	48
17 mm	23 mm	2,5 mm	2250017P	2251017	1/10 Oz American Eagle / Britannia / Kangaroo / Krugerrand (gold), 1/10 Oz Britannia (silver)					
18 mm	24 mm	2,45 mm	2250018P	2251018	20 € "Deutscher Wald" (gold), 5 Marks Kaiserreich (gold), 5 Rappen					
19 mm	25,5 mm	2,5 mm	2250019P	2251019	2 €-Cent, 5 Pfennig, 50 Rappen, 1/10 Oz Panda / Lunar II (gold)					
20 mm	26 mm	2,5 mm	2250020P	2251020	10 €-Cent, 2 Pfennig, 10 Marks Kaiserreich (gold), 10 Crowns Austria (gold), 10 Rappen, 10 Vreneli CHF (gold)	2548	2948	---	---	48
21 mm	27 mm	2,5 mm	2250021P	2251021	50 Pfennig, 1/4 Oz "Luther Rose" 50 € (gold), 2 Rappen, 1/4 Oz Kangaroo / Maple Leaf (gold), 1/10 Oz Koala / Libertad (silver)					
21,5 mm	27,5 mm	2,75 mm	2250215P	2251215	5 €-Cent, 20 Crowns Austria (gold), 20 Rappen, 20 Vreneli CHF (gold)					
22 mm	28 mm	2,55 mm	2250022P	2251022	10 Pfennig					
22,5 mm	28,5 mm	2,6 mm	2250225P	2251225	20 €-Cent, 1 Pound Great Britain (gold), 1/4 Oz France (gold), 1/4 Oz American Eagle / Britannia / Krugerrand / Panda / Queen's Beasts / Vienna Philharmonic (gold), 1/4 Oz Britannia (silver)	2529	2929	---	---	42
23 mm	29 mm	2,75 mm	2250023P	2251023	20 Marks Kaiserreich (gold), 1/4 Oz Lunar II (gold), 1 Franc (silver)					
23,5 mm	29,5 mm	2,85 mm	2250235P	2251235	1 €, 1 CHF, 1/4 Oz Libertad (gold)					
24 mm	30 mm	2,85 mm	2250024P	2251024	1 DM, 1 DM (gold), 5 Austrian shillings					
24,5 mm	30,5 mm	2,75 mm	2250245P	2251245	50 €-Cent, 1 Marks Kaiserreich (silver), 25 Cent (USA, State Quarters)					
25 mm	31 mm	2,85 mm	2250025P	2251025	10 Roubles Alexander III, 1886-1894 (gold), 15 Roubles Nicholas II, 1897 (gold)	2530	2930	2530M	2530C	35
26 mm	32 mm	2,9 mm	2250026P	2251026	2 €, 10 Francs ab 1974, 1/2 Oz Kangaroo / Maple Leaf (gold), 1/4 Oz Panda (silver)					
27 mm	33 mm	2,9 mm	2250027P	2251027	2 DM, 2 Reichsmark (Ag/Cu), 50 Kopeek Nicholas II, 1895-1914 (silver)					
27,5 mm	33,5 mm	2,95 mm	2250275P	2251275	5 € Germany, 1/2 Oz American Eagle / Britannia / Krugerrand / Panda (gold), 1/4 Oz Libertad (silver), 1/2 Oz Britannia (silver)	2535	2935	---	---	35
28 mm	34 mm	3,0 mm	2250028P	2251028	50 Austrian shillings, 1996-2001 (Bi-metal), 20 Austrian shillings, 2 CHF, 50 Francs (gold)					
29 mm	35 mm	3,3 mm	2250029P	2251029	10 € Polymer Germany, 100 € commemorative coin Germany (gold), 2 Marks Kaiserreich (silver), 5 Francs from 1960 (silver), 1/2 Oz Vienna Philharmonic (gold)					
29,5 mm	35,5 mm	3,3 mm	2250295P	2251295	5 € Austria, 5 DM, 5 Marks/DDR (Cu/Ni), 1/2 Oz Libertad (gold)	2225	2625	---	---	35
30 mm	36 mm	3,3 mm	2250030P	2251030	2 Austrian shillings					
30,5 mm	36,5 mm	3,3 mm	2250305P	2251305	1 Oz Maple Leaf (gold)					
31 mm	37 mm	3,3 mm	2250031P	2251031	3 Reichsmark (Ag/Cu), 25 Austrian shillings, 1/2 Oz Lunar II (gold), 100 Francs (silver)					
31,5 mm	38 mm	3,15 mm	2250315P	2251315	10 € France (silver), 1/2 Oz France (silver), 1 Roubels (Russia)	2537	2937	2537M	2537C	30
32 mm	38 mm	3,15 mm	2250032P	2251032	10 Marks/DDR (Cu/Ni), 5 CHF, 1 Oz Panda (gold)					
32,5 mm	37,5 mm	3,25 mm	2260325P	2261325	10 €/20 € Silver Germany (Special Capsule: Same as the original capsule 10 €/20 € proof silver coins Germany)					
32,5 mm	38,5 mm	2,7 mm	2250325P	2251325	10 €/20 € Silver Germany, 10 DM, 200 € gold coin, 1 Oz Niue Turtle (gold)					
33 mm	39 mm	3,2 mm	2250033P	2251033	1 Oz American Buffalo / American Eagle / Britannia / Kangaroo / Krugerrand / Queen's Beasts (gold)	2226	2626	2226M	2226C	30
33,5 mm	39,5 mm	3,35 mm	2250335P	2251335	3 Marks Kaiserreich (silver), 20 € France (silver), 3 Roubels (Cu/Ni), 5 Roubels Olympia (silver)					
34 mm	40,5 mm	3,25 mm	2250034P	2251034	100 Austrian shillings (gold), 20 CHF, 1/2 Oz Libertad (silver)					
34,5 mm	40,5 mm	3,25 mm	2250345P	2251345	Médailles Souvenirs, 3 € "Tiertaler" Austria, 1/2 Oz Maple Leaf / Panda (silver)	2224	2624	---	---	24



Coin capsule set for one €-coin set
2250E

Capsules for €-coins

	20 mm	22,5 mm	24,5 mm	23,5 mm	26 mm	27,5 mm	29 mm	32,5 mm
Pack of 10	2250020P	2250225P	2250245P	2250235P	2250026P	2250275P	2250029P	2250325P 2260325P
Pack of 100	2251020	2251225	2251245	2251235	2251026	2251275	2251029	2251325 2261325



COIN CAPSULES

FOR COINS Ø 35 - 51 mm

					SUITED FOR:	MATCHING COIN BOX		Compartmentments
35 mm	41 mm	3,25 mm	S2250035P	S2251035	20 US \$ Libertad (gold), 20 Francs (1929-1939), 100 Francs (gold), 1 Oz Libertad (gold)	2224	2624	24
35,5 mm	41,5 mm	3,4 mm	S2250355P	S2251355	100 Vreneli CHF (gold), 5 Roubels (Cu/Ni), 5 Roubels Alexander II, 1855-1881 (gold), 5 Roubels Alexander III, 1881-1885 (gold)	2103	2703	20
36 mm	42 mm	3,25 mm	S2250036P	S2251036	100 Austrian shillings (silver)	2544	2944	20
37 mm	43 mm	3,05 mm	S2250037P	S2251037	5 Reichsmark (Ag/Cu), 5 Francs until 1889 (silver), 1/2 Oz Koala / Lunar II (silver)	2220	2620	20
37,5 mm	44,5 mm	3,35 mm	S2250375P	S2251375		2544	2944	20
38 mm	44 mm	3,5 mm	S2250038P	S2251038	1 Oz Vienna Philharmonic (gold), 1 Oz Vienna Philharmonic (silver)			
38,5 mm	45,5 mm	3,5 mm	S2250385P	S2251385	5 Marks Kaiserreich (silver), 500 Austrian shillings (silver), 1 Oz Canadian Wildlife / Maple Leaf (silver)			
39 mm	45 mm	3,25 mm	S2250039P	S2251039	1 Oz Krugerrand (silver), 1 Oz BIG FIVE, South Africa (silver)	2220	2620	20
39,5 mm	45 mm	3,25 mm	S2250395P	S2251395	3 Roubles commemorative coin (silver)			
40 mm	46 mm	3,2 mm	S2250040P	S2251040	1 Oz Lunar II (gold), 10 Roubels Olympia (silver)			
40,5 mm	46,5 mm	3,5 mm	S2250405P	S2251405	1 Oz Britannia / Libertad / Niue Turtle (silver)			
41 mm	47 mm	3,25 mm	S2250041P	S2251041	1 Silver Dollar, 2 Oz Kangaroo (gold), 1 Oz American Eagle / Kangaroo / Koala / Kookaburra / Panda (silver)	2520	2920	20
42 mm	48 mm	3,5 mm	S2250042P	S2251042	50 € France (silver), 2 Oz Lunar II (gold)			
43 mm	49 mm	4,2 mm	S2250043P	S2251043		2543	2943	20
44 mm	50 mm	3,85 mm	S2250044P	S2251044		2515	2915	15
45 mm	51 mm	4,25 mm	S2250045P	S2251045				
46 mm	52,5 mm	4,1 mm	S2250046P	S2251046	1 Oz Lunar II (silver)			
47 mm	53 mm	4,25 mm	S2250047P	S2251047		2554	2954	12
48 mm	54 mm	4,45 mm	S2250048P	S2251048	100 € France (silver)			
49 mm	55 mm	4,35 mm	S2250049P	S2251049	2 Oz Libertad (silver)			
50 mm	56 mm	4,25 mm	S2250050P	S2251050		2212	2612	12
51 mm	57 mm	4,90 mm	S2250051P	S2251051				



RECTANGULAR COIN CAPSULES

Suited for 1 Oz Australia bullion (Silver coin bars).

Internal measurements:

27 x 47 x 3 mm

External measurements:

34 x 54 x 6,5 mm

PACK OF 10

S22552747P

COIN CAPSULES FOR BIGGER AND THICKER COINS

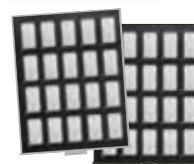

Suitable coin boxes for rectangular coin capsules can be found on page 9.

					SUITED FOR:	
20,1 mm	26,3 mm	4,5 mm	8,5 mm	---	S22702010P	---
24,1 mm	30,3 mm	4,5 mm	7,8 mm	---	S22702410P	---
35,45 mm	40,56 mm	5,07 mm	8,7 mm	---	S22703545P	---
38,4 mm	45 mm	4,5 mm	7,3 mm	---	S2255384P	S2255384
39 mm	45 mm	6 mm	8,6 mm	---	S2255039P	S2255039
40,4 mm	44,8 mm	6,6 mm	10,3 mm	---	S22704040P	---
41 mm	47 mm	5,5 mm	7,6 mm	---	S2255041P	---
45 mm	50,6 mm	4,8 mm	9,0 mm	---	S22704500P	---
50,3 mm	55,8 mm	8,5 mm	11,6 mm	---	S22705030P	---
55 mm	60,1 mm	3,2 mm	6,6 mm	S22705500	---	---
60 mm	65,1 mm	5,3 mm	9,0 mm	S22706000	---	---
65 mm	69,8 mm	5,4 mm	9,5 mm	S22706500	---	---
70 mm	74,5 mm	5,5 mm	9,3 mm	S22707000	---	---
80 mm	87,1 mm	5,7 mm	10,5 mm	S22708000	---	---
100 mm	110,5 mm	8,5 mm	13,8 mm	S22710000	---	---
101,3 mm	110 mm	13,2 mm	20,1 mm	S22500439	---	---
120 mm	130 mm	9,2 mm	13,4 mm	S22712000	---	---

For coins with a thickness of 6,5 mm or more, we recommend collecting in LINDNER d-Boxes (see page 10).

Delivery do not include contents / display material. All specifications are subject to change without prior notice.

HARTBERGER® COIN HOLDERS AND ACCESSORIES

Coin holders from HARTBERGER® offer a different storage solution for the coin collector. Popular for many years, they are very easy to use: Place coin on the one side of the frame and fold together. HARTBERGER® Coin holders are made of cardboard and softener-free foil. They are available either self-adhesive or non-adhesive (needs to be stapled).

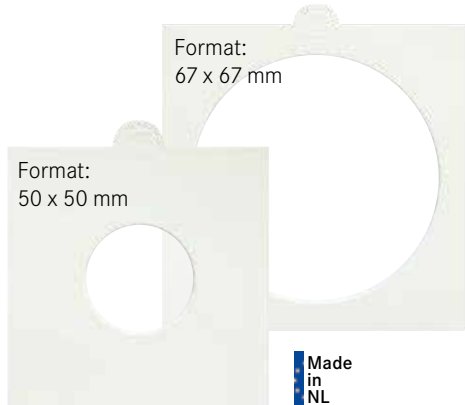

	SELF-ADHESIVE 50 x 50 mm			NON ADHESIVE 50 x 50 mm		
	25x	100x	1000x	25x	100x	1000x
15 mm	8320015	8322015	8321015	8330015	8332015	8331015
17,5 mm	8320175	8322175	8321175	8330175	8332175	8331175
20 mm	8320020	8322020	8321020	8330020	8332020	8331020
22,5 mm	8320225	8322225	8321225	8330225	8332225	8331225
25 mm	8320025	8322025	8321025	8330025	8332025	8331025
27,5 mm	8320275	8322275	8321275	8330275	8332275	8331275
30 mm	8320030	8322030	8321030	8330030	8332030	8331030
32,5 mm	8320325	8322325	8321325	8330325	8332325	8331325
35 mm	8320035	8322035	8321035	8330035	8332035	8331035
37,5 mm	8320375	8322375	8321375	8330375	8332375	8331375
39,5 mm	8320395	8322395	8321395	8330395	8332395	8331395
assorted	8320000	---	---	---	---	---

HARTBERGER® Coin holders with oval cutting
38 x 24 mm for Pressed Pennies

	SELF-ADHESIVE 50 x 50 mm			NON ADHESIVE 50 x 50 mm		
	25x	100x	1000x	25x	100x	1000x
38 x 24 mm	8320243	8322243	8321243	8330243	8332243	8331243

	SELF-ADHESIVE 67 x 67 mm			NON ADHESIVE 67 x 67 mm		
	25x	100x	1000x	25x	100x	1000x
40 mm	8320040		8321040	8330040		8331040
43 mm	8320043	---	8321043	8330043	---	8331043
48 mm	8320048		8321048	8330048		8331048
53 mm	8320053		8321053	8330053		8331053

HARTBERGER® RING BINDER AND COIN PAGES

RING BINDER BIG

Ring binder LUXUS, blue
Synthetic material padded and welded,
Format: 310 x 280 x 50 mm
Mechanism: 4-ring, 80/80/80 mm
€ 8300-B

Companion Set:
Ring binder LUXUS with Slipcase, blue
€ 83008301-B

Ring binder STANDARD, blue
Synthetic material unpadded and welded,
Format: 310 x 280 x 50 mm
Mechanism: 4-ring, 80/80/80 mm
€ 8304-B

Companion Set:
Ring binder STANDARD with Slipcase, blue
€ 83048301-B

**Slipcase for Ring binder
8300 and 8304, blue**
Format: 315 x 285 x 55 mm
€ 8301-B

RING BINDER SMALL

Ring binder LUXUS, blue
Synthetic material padded and welded,
Format: 235 x 235 x 45 mm
Mechanism: 4-ring, 45/65/45 mm
€ 8200-B

Companion Set:
Ring binder LUXUS with Slipcase, blue
€ 82008201-B

Slipcase for Ring binder 8200, blue
Format: 240 x 240 x 50 mm
€ 8201-B



HARTBERGER® Coin pages BIG (Format: 245 x 285 mm)

Suited for 20 coin holders 50 x 50 mm, Pack of 10	€ 8310
Suited for 20 coin holders 50 x 50 mm, SUPER PLUS**, Pack of 10	€ 8311SP
Suited for 9 coin holders 67 x 67 mm, SUPER*, Pack of 10	€ 8312
Suited for 12 coin holders 50 x 50 mm, SUPER*, Pack of 10	€ 8308
Plain white cards, size 20 x 50 mm, for identification purposes etc. for pages 8308, Pack of 120	€ 8309-7
Black Interleaving Pages, Pack of 10	€ 8318

HARTBERGER® System pages BIG (Format: 240 x 300 mm)

with 1 pocket (226 x 295 mm), Pack of 5	€ HB-S-1
with 2 strips (226 x 147 mm), Pack of 5	€ HB-S-2
with 3 strips (226 x 97 mm), Pack of 5	€ HB-S-3
with 4 strips (226 x 73 mm), Pack of 5	€ HB-S-4

HARTBERGER® Coin pages SMALL (Format: 185 x 225 mm)

Suited for 12 coin holders 50 x 50 mm, Pack of 10	€ 8210
Suited for 12 coin holders 50 x 50 mm, SUPER*, Pack of 10	€ 8211
Suited for 6 coin holders 67 x 67 mm, SUPER*, Pack of 10	€ 8212
Black Interleaving Pages, Pack of 10	€ 8218

*SUPER = reinforced holes / **SUPER PLUS = reinforced holes, extra +/- 30% thicker foil



HARTBERGER® ASSORTI-BOX

1200 coin holders in a box; (335 x 185 x 120 mm)
Assortment: each 100x 15,0 mm, 17,5 mm, 20,0 mm, 25,0 mm, 27,5 mm, 30,0 mm, 32,5 mm, 35,0 mm, 37,5 mm, 39,5 mm and 200 x 22,5 mm.
☛ 8323 Self-adhesive
☛ 8325 Non adhesive



HARTBERGER® ASSORTI-BOX EURO

500 coin holders in a box; (285 x 105 x 120 mm).
Assortment: each 100x 17,5 mm, 20,0 mm, 22,5 mm, 25,0 mm and 27,5 mm.
☛ 8324 Self-adhesive



STAPLER

for HARTBERGER® Coin holders, chrome (staples not included).
☛ 8340

STAPLES, ZINC-PLATED

Pack of 1000
☛ 8341

LINDNER ACCESSORIES

FOR HARTBERGER® COIN HOLDERS

COIN BOX

(see page 8).

- 2122
- 2722
- 2122M
- 2122C

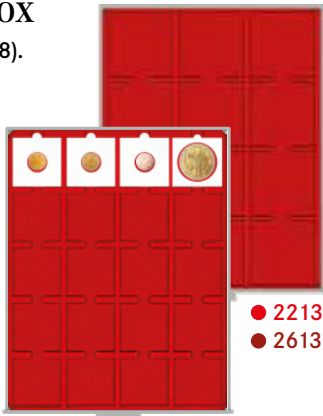

- 2213
- 2613

POCKET ALBUM FOR 60 COIN HOLDERS

Handy pocket album with padded dark blue cover. With 10 crystal clear synthetic sleeves suitable for 6 coin holders 50 x 50 mm each.



☛ S816



☛ 2245

WOOD BOX FOR COIN HOLDERS

(see page 17).

NERA CASE XL

for 60 Coin holders
(see page 27).



- 2365-2122E
- 2365-2722E
- 2365-2122ME
- 2365-2122CE

LARGE COIN CARRYING CASE

for 120 Coin holders
(see page 20).



- 2338-120
- 2338M-120

SOLID WOOD CASE CARUS

for 80 Coin holders
(see page 29).



- 2494-3
- 2494-3M

NERA CASE M

for 20 Coin holders
(see page 26).

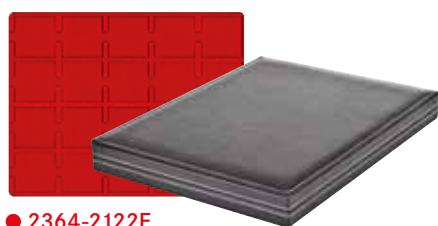

- 2364-2122E
- 2364-2722E
- 2364-2122ME
- 2364-2122CE

LARGE ALU-COIN CASE

for 75 Coin holders
(see page 21).



- S2340-75
- S2340M-75

SOLID WOOD CASE CARUS-1

for 20 Coin holders
(see page 28).



- S2491-2722E
- S2491-2122ME

OCTO COIN CAPSULES FOR COINS Ø 14 - 41 mm



Made in EU

Format:
50 x 50 mm

COINS OF DIFFERENT SIZES IN ONE COLLECTION SYSTEM

From pennies to gold coins – all in one system. This is a collecting and presentation system in order to protect coins of different diameters in coin capsules and at the same time present them elegantly in coin boxes, coin cases or coin pages. One "Coin OCTO" consists of an octagonal distance disc made of high-quality acrylic glass with an outside measurement of 50 x 50 mm and a corresponding LINDNER coin capsule. The distance disc has to be placed between the bottom and lid of the corresponding coin capsule. By this the different coin diameters are evened out. The LINDNER coin capsules are extremely scratch resistant and provide the perfect protection and a "crystal clear" view of your coins.

14,0 mm	☞ OS014	27,0 mm	☞ OS027
15,0 mm	☞ OS015	28,0 mm	☞ OS028
16,0 mm	☞ OS016	29,0 mm	☞ OS029
16,5 mm	☞ OS165	29,5 mm	☞ OS295
17,0 mm	☞ OS017	30,0 mm	☞ OS030
18,0 mm	☞ OS018	31,0 mm	☞ OS031
19,0 mm	☞ OS019	32,0 mm	☞ OS032
20,0 mm	☞ OS020	32,5 mm	☞ OS325
21,0 mm	☞ OS021	33,0 mm	☞ OS033
21,5 mm	☞ OS215	34,0 mm	☞ OS034
22,0 mm	☞ OS022	35,0 mm	☞ OS035
22,5 mm	☞ OS225	36,0 mm	☞ OS036
23,0 mm	☞ OS023	37,0 mm	☞ OS037
23,5 mm	☞ OS235	38,0 mm	☞ OS038
24,0 mm	☞ OS024	39,0 mm	☞ OS039
24,5 mm	☞ OS245	40,0 mm	☞ OS040
25,0 mm	☞ OS025	41,0 mm	☞ OS041
26,0 mm	☞ OS026		

Pack of 2

Examples of use see page 16-17.

CARUS-4

Solid Wood Case CARUS-4 for 80 Coin OCTOS/CARRÉE (see page 29).



Made in Germany

- 2494-3
- 2494-3M

CARUS-1

Solid Wood Case CARUS-1 for 20 Coin OCTOS/CARRÉE (see page 28).



Made in Germany

- S2491-2722E
- S2491-2122ME

NERA XL

NERA Case XL for 60 Coin OCTOS/CARRÉE (see page 27).



- 2365-2122E
- 2365-2722E
- 2365-2122ME
- 2365-2122CE

NERA M

NERA Case M for 20 Coin OCTOS/CARRÉE (see page 26).



- 2364-2122E
- 2364-2722E
- 2364-2122ME
- 2364-2122CE

NIMBUS DISPLAY FRAMES

For presentation of one coin in a coin capsule OCTO/CARRÉE. Open the NIMBUS frame and put the coin capsule into the recess. After that, close the NIMBUS frame. A magnetic closure holds the frame together.



- 4834

COIN BOX

Coin box for 20 Coin OCTOS/CARRÉE (see page 8).



Made in Germany

- 2122
- 2722
- 2122M
- 2122C

WOOD BOX

FOR COIN HOLDERS / CARRÉE / OCTOS

Dark stained authentic wood box with 4 solid closures and a removable lid. With 15 fixed compartments 52 x 68 mm. Suited for approx. 400 Coin holders 50 x 50 mm / Rebeck Coin L-Coin holders or 135 Coin capsules CARRÉE. Format: 295 x 230 x 85 mm



€ 2245



Made in Germany

CARUS-4

Solid Wood Case CARUS-4 for 80 Coin OCTOS/CARRÉE (see page 29).



Made in Germany

- 2494-2122ME
- 2494-2122CE

NERA CASE M PLUS - WITH WINDOW

NERA Case M PLUS - with window for 20 Coin OCTOS/CARRÉE (see page 26).



- 2367-2122E
- 2367-2722E
- 2367-2122ME
- 2367-2122CE

NERA XM / NERA S

NERA Case XM for 12 Coin OCTOS/CARRÉE or NERA Case S for 4 Coin OCTOS/CARRÉE (see page 24-25).



NERA XM ● 2363-12

NERA S ● 2362-4

SOLID WOOD COIN CASE

Solid Wood Coin Case for 100 Coin OCTOS/CARRÉE (see page 30).



Made in Germany

- S2495-S2122ME
- S2495-S2122CE

COIN CAPSULES CARRÉE

FOR COINS Ø 4 - 41 mm



Made in EU

Format: 50 x 50 mm

The uniform external format (50 x 50 mm) of the coin capsule offers the option of collecting coins of different diameters in one collecting system. The softener and acid free block-foam inserts are available in diameters from a size of 14 mm to 41 mm - for all current coins.

The coin capsules are extremely scratch resistant and provide the perfect protection and a "crystal clear" view of your coins. In addition to the robust material, the protective rim on the bottom and the lid of the capsule prevent scratching of the capsules.

14,0 mm	€ 2240014	28,0 mm	€ 2240028
15,0 mm	€ 2240015	29,0 mm	€ 2240029
16,0 mm	€ 2240016	30,0 mm	€ 2240030
17,0 mm	€ 2240017	31,0 mm	€ 2240031
18,0 mm	€ 2240018	32,0 mm	€ 2240032
19,0 mm	€ 2240019	33,0 mm	€ 2240033
20,0 mm	€ 2240020	34,0 mm	€ 2240034
21,0 mm	€ 2240021	35,0 mm	€ 2240035
22,0 mm	€ 2240022	36,0 mm	€ 2240036
23,0 mm	€ 2240023	37,0 mm	€ 2240037
24,0 mm	€ 2240024	38,0 mm	€ 2240038
25,0 mm	€ 2240025	39,0 mm	€ 2240039
26,0 mm	€ 2240026	40,0 mm	€ 2240040
27,0 mm	€ 2240027	41,0 mm	€ 2240041

One package consists out of 4 coin capsules CARRÉE incl. one 3 mm thick inlay each. Made of a black softener and acid free block-foam. For the accurate storage of the coins!

Pack of 4

STORAGE SYSTEMS FOR SLABS



Slabs up to a size of 63 x 85 mm (PCGS/NGC).

ALU-CASE FOR 30 SLABS

Compact case in aluminium-design with foamed inserts for max. 30 Slabs.

Handle in the middle of the lid.

Format:
245 mm x 180 mm (incl. closures) x
125 mm (incl. handle)

€ S2330



COIN BOX FOR 9 SLABS

(see page 9)



Made in Germany

- 2219
- 2619
- 2219M

CARUS

Solid Wood Case
CARUS for
36 Slabs

(see page 29)

Made in Germany

- 2494-19
- 2494-19M



CARUS-1

Solid Wood Case
CARUS-1 for
9 slabs

(see page 28)

Made in Germany

- S2491-2619E
- S2491-2219ME



NERA M PLUS - WITH WINDOW

NERA M PLUS Case with window for 9 Slabs
(see page 26)



- 2367-2219E
- 2367-2619E
- 2367-2219ME

NERA XL

NERA XL Case for 27 Slabs
(see page 27)



- 2365-2219E
- 2365-2619E
- 2365-2219ME

NERA M

NERA M Case for 9 Slabs
(see page 26)



- 2364-2219E
- 2364-2619E
- 2364-2219ME

COIN CARRYING CASES

(see page 23)



● S2307-S2219ME

NIMBUS ECO

(see page 98-99)

- 4836-B
- 4836-S
- 4836-WS



NIMBUS 230

(see page 98-99)



- 4831
- 4851

COLLECTION CASE MULTI

ALL ROUNDER FOR DIFFERENT AREAS OF COLLECTION

The universal case for many different collection areas with many application options. Enthusiasts and collectors of commemorative coin sets and postcards have a perfect opportunity to store their collections in this case. With its 6 compartment dividers, the object can be sorted and viewed ideally.

COLLECTION CASE ALU MULTI PLUS

Lockable case for commemorative coin sets, postcards, letters, stamps in stock cards. The interior with 6 fixed compartments is covered with a noble, black velour flock.

With foldable carrying handle inserted into the center of the lid. Lid is removable!

Also suitable for receipts or stock cards in A5 format or for certified banknotes!

Material: Aluminium, silver

Format: 240 x 200 x 360 mm

Suited for: Objects up to 170 x 220 mm

☛ S2332

Stock cards A5 see page 92.

COLLECTION CASE ALU MULTI

Lockable case for commemorative coin sets, postcards, letters, stamps in stock cards. The interior with 6 fixed compartments is covered with a noble, black velour flock.

With foldable carrying handle inserted into the center of the lid. Lid is removable!

Ideal also for the original 20 Euro collectors coin sets!

Material: Aluminium, silver

Format: 200 x 200 x 360 mm

Suited for: Objects up to 170 x 180 mm

☛ S2331



NIMBUS DISPLAY FRAMES

Give your favourite collectables that "special look" Details as well as the complete assortment of NIMBUS-Frames can be found on pages 98-99.

LOOKS LIKE
THE OBJECTS
ARE FLOATING



TRAYS FOR COIN CARRYING CASES

Extremely solid trays, covered with red or dark blue velour all around. Suitable for the large coin carrying case, the ALU coin case and the MAGNUS coin case. Format: 331 x 220 x 9 mm

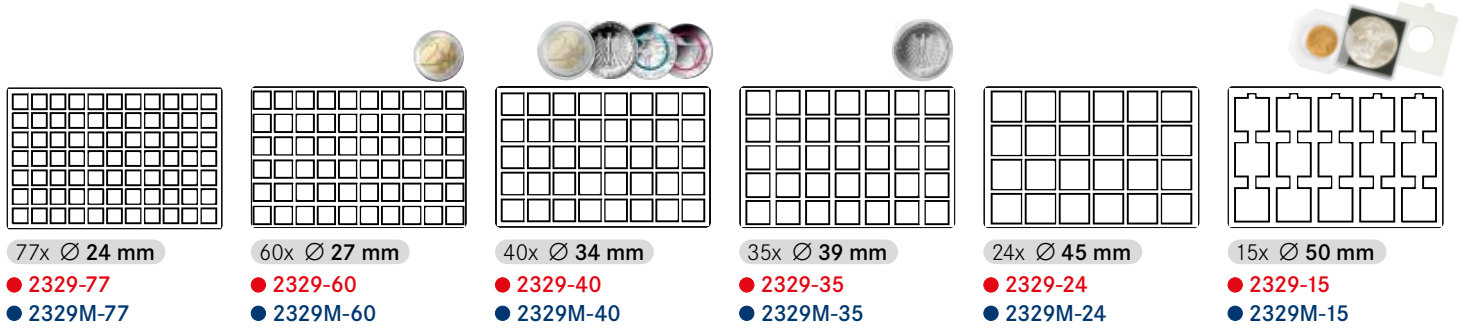

77x Ø 24 mm
● 2329-77
● 2329M-77

60x Ø 27 mm
● 2329-60
● 2329M-60

40x Ø 34 mm
● 2329-40
● 2329M-40

35x Ø 39 mm
● 2329-35
● 2329M-35

24x Ø 45 mm
● 2329-24
● 2329M-24

15x Ø 50 mm
● 2329-15
● 2329M-15

LARGE COIN CARRYING CASE

Collecting case in an elegant, black aluminium design. The matching trays are very sturdy and entirely covered in red or dark blue velour which ensures easy handling. The eight synthetic feet ensure stability and protects the table, the shelf, etc from scratches. The case is lockable.

Format: 350 x 240 x 89 mm



WITH 8 COIN TRAYS

WITH 8 MIXED COIN TRAYS

for 355 coins

ASSORTEMENT:

- 1x 77x Ø 24.0 mm
 - 2x 60x Ø 27.0 mm
 - 1x 40x Ø 34.0 mm
 - 2x 35x Ø 39.0 mm
 - 2x 24x Ø 45.0 mm
- 2338 ● 2338M

WITH 8 IDENTICAL COIN TRAYS

for 616 coins

8x 77x Ø 24.0 mm

- 2338-616 ● 2338M-616

for 480 coins

8x 60x Ø 27.0 mm

- 2338-480 ● 2338M-480

for 320 coins

8x 40x Ø 34.0 mm

- 2338-320 ● 2338M-320

for 280 coins

8x 35x Ø 39.0 mm

- 2338-280 ● 2338M-280

for 192 coins

8x 24x Ø 45.0 mm

- 2338-192 ● 2338M-192

for 120 coins

8x 15x Ø 50.0 mm

- 2338-120 ● 2338M-120

WITH 8 COIN TRAYS OF YOUR CHOICE

Please quote the order-no. of the selected trays when placing your order.

- 2338NW ● 2338MNW

EMPTY (without trays)

Interior colour: red

- 2338o

Interior colour: black

- 2338o-S

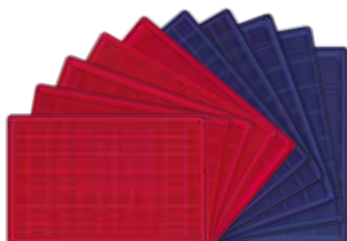

LARGE ALU-COIN CASE

Lockable coin case in noble aluminium-design with 5 coin trays. The trays are extremely stable and are covered with red or dark blue velour. The synthetic feet enable it to stand securely and protects the table, the shelf etc. from being scratched.

Format: 350 x 240 x 63 mm

WITH 5 COIN TRAYS



WITH 5 MIXED COIN TRAYS

for 236 coins

ASSORTEMENT:

1x 77x Ø 24.0 mm

1x 60x Ø 27.0 mm

1x 40x Ø 34.0 mm

1x 35x Ø 39.0 mm

1x 24x Ø 45.0 mm

● S2340 ● S2340M

WITH 5 IDENTICAL COIN TRAYS

for 385 coins

5x 77x Ø 24.0 mm

● S2340-385 ● S2340M-385

for 300 coins

5x 60x Ø 27.0 mm

● S2340-300 ● S2340M-300

for 200 coins

5x 40x Ø 34.0 mm

● S2340-200 ● S2340M-200

for 175 coins

5x 35x Ø 39.0 mm

● S2340-175 ● S2340M-175

for 120 coins

5x 24x Ø 45.0 mm

● S2340-120 ● S2340M-120

for 75 coins

5x 15x Ø 50.0 mm

● S2340-75 ● S2340M-75

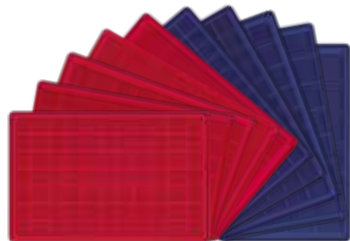

WITH 5 COIN TRAYS OF YOUR CHOICE

Please quote the order-no. of the selected trays when placing your order.

● S2340NW ● S2340MNW

EMPTY (without trays)

Interior colour: black

● S2340o

ALU CARRYING CASE MAGNUS

Large, lockable coin case in noble aluminium design. The synthetic feet enable it to stand securely and protects the table, the shelf etc. from being scratched. The two additional locks at both sides of the case, ensure that the case remains firmly closed during transportation.

Format: 370 x 260 x 200 mm

Capacity: max. 17 trays

MAX. 17 TRAYS

Fitting trays see page 20.



WITH 10 COIN TRAYS OF YOUR CHOICE

Please quote the order-no. of the selected trays when placing your order.

☒ 2317NW

EMPTY (without trays)

Interior colour: light red

☒ 2317o

COIN BOX CARRYING CASES

The practical LINDNER Coin box carrying cases are made to a high quality and they are lockable. You can stack your coin boxes and collecting boxes which are designed to help save space as you can stack your coin boxes and collection boxes in these carry cases. You can use them for transportation purposes or for permanent storage at home.



☛ 2310

COIN BOX CARRYING CASE NERA MB 10

NERA MB 10 offers space for 10 coin boxes and is lockable. Timeless elegance, a clear design, versatility, functionality and most of all a special touch. These are the magnificent features of our NERA series. The grained surface in leather-effect with the crème-coloured stitching grants this carrying case its individual character. The double-wing doors ensure safe and simple handling, all the while offering protection for your coin boxes. With these new features in material and functionality, NERA MB 10 offers perfect conditions for storage or transportation of your coin boxes.

Suited for: 10 coin boxes
Format: 265 x 325 x 255 mm
4 synthetic feet
☛ 2310



☛ 2312

COIN BOX CARRYING CASE “ALUMINIUM” MB 10

A LINDNER Coin box carrying case in new design
The coin box carrying case offers space for 10 coin boxes or 5 collection boxes and is lockable. The double-wing doors ensure a safe and simple handling, all the while offering protection for your coin boxes or collection boxes.

Suited for: 10 coin boxes or 5 collection boxes
Format: 255 x 340 x 255 mm
4 synthetic feet
☛ 2312

COIN BOX CARRYING CASE “ALUMINIUM”

Case made of aluminium. The inside is lined with red velvet and has a handle on the top.

Suited for:
8 coin boxes or 4 collection boxes
Format: 260 x 340 x 200 mm
4 synthetic feet

☛ 2358



☛ 2358

☛ 2319

COIN BOX CARRYING CASE COMPACT

Lockable Coin box carrying case covered with black leatherette. The inside is lined with black velvet. Can be stacked without any problems, because of the foldable carrying handle in the middle of the top.

Suited for:
8 coin boxes or 4 collection boxes
Format: 255 x 345 x 220 mm
4 synthetic feet

☛ 2319

COIN CASE ALU

Lockable ALU Coin case for 6 black or dark blue coin trays.

Format: 305 x 265 x 75 mm

WITH 6 COIN TRAYS



WITH 6 MIXED COIN TRAYS

for 177 Coins







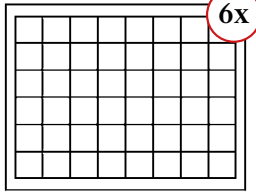

ASSORTEMENT:

- 1x 48x Ø 30.0 mm
- 1x 35x Ø 36.0 mm
- 1x 30x Ø 38.0 mm
- 1x 24x Ø 42.0 mm
- 2x 20x Ø 47.0 mm

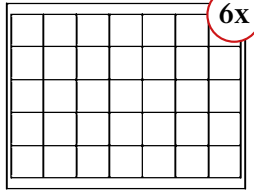
- S2307-177
- S2307-177M

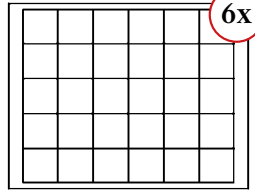
EMPTY (without trays)
Interior colour: black
● S2307o

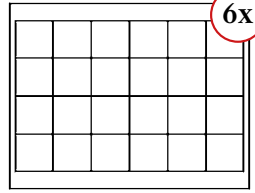
COIN CASE ALU WITH 6 IDENTICAL COIN TRAYS:

 	 	 	 	 
<p>Ø 30 mm 288x ● S2307-S2148CE ● S2307-S2148ME</p>	<p>Ø 36 mm 210x ● S2307-S2135CE ● S2307-S2135ME</p>	<p>Ø 38 mm 180x ● S2307-S2115CE ● S2307-S2115ME</p>	<p>Ø 42 mm 144x ● S2307-S2124CE ● S2307-S2124ME</p>	<p>Ø 47 mm 120x ● S2307-S2120CE ● S2307-S2120ME</p>

COIN CASE ALU FOR 36 SLABS

Format: 305 x 265 x 75 mm



WITH 4 COIN TRAYS

Scope of delivery: 4 blue coin trays with 9 square compartments each. The coin inserts are covered with high-quality velour.

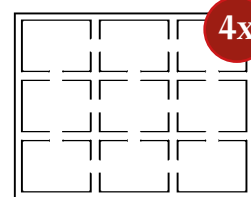

63 x 85 mm 36x
● S2307-S2219ME



NERA SERIES

FOR STORING COINS AND OTHER TREASURES IN A NEW DESIGN

Timeless elegance, a clear design, versatility, functionality and most of all, a special touch – these are the magnificent features of our NERA series. The grained structure of the material in conjunction with the crème coloured stitching

grants this series its individual character. The graphite coloured and padded lining of the lid of each NERA case provides an attractive contrast to the inserts and your coins. With the many different sizes and different colour inserts

available, the NERA series is the perfect choice for single coins or a complete collection, leaving nothing to be desired.



NERA XS

The smallest version of this series is designed to display that special coin. Whether you are looking for a suitable spot for your favourite collectible or for elegant packaging for a coin gift: our NERA XS offers a variety of purposes. The black velour-like coin insert is a perfect complement to silver or gold coins.

Format: 98 x 88 x 42 mm

NERA Case XS incl. coin capsule

Comes with one capsule which features adjustable distance rings. The red rings can be adjusted to the size of the coin. For coin sizes Ø 16-51 mm.

☛ 2360

NERA Case XS incl. insert with concave indentation

Suited for coins up to Ø 60 mm.

☛ 2361

NERA Case XS incl. patented form-adaptive insert

With patented "push in"-insert in which you can place any coin up to Ø 70 mm.

☛ 2366

NERA S

NERA Case S – A stylish storage for sets of 4 or 5 coins. Choose between 4 square compartments for coins or capsules up to Ø 52 mm or 5 square compartments for coins or capsules up to Ø 40 mm. The coin inserts display silver as well as gold coins which is enhanced by a black, velour-like surface.

Format: 243 x 77 x 38 mm

With 4 square compartments for coins or coin capsules up to Ø 52 mm.

☛ 2362-4

With 5 square compartments for coins or coin capsules up to Ø 40 mm.

☛ 2362-5

Coin case with a foam insert "BLACK VELVET" with 5 round compartments incl. 5 LINDNER coin capsules.

NERA Case S for 5x 5 € collector coins Germany (incl. coin capsules).

☛ S2362-5EK

NERA Case S for 5x 10 € collector coins Germany with polymer ring (incl. coin capsules).

☛ S2362-10EK



NERA XM

Our NERA Case XM is the perfect solution for storing 12 or 15 coins. Choose between 12 square compartments for coins or coin capsules up to Ø 52 mm or 15 square compartments for coins or capsules up to Ø 40 mm. The coin inserts with a black, velour-like surface, display silver as well as gold coins.

Format: 243 x 187 x 38 mm

With 12 square compartments for coins or coin capsules up to Ø 52 mm.

☛ 2363-12

With 15 square compartments for coins or coin capsules up to Ø 40 mm.

☛ 2363-15

Coin case with a foam insert "BLACK VELVET" with 15 compartments incl. 15 LINDNER coin capsules.

NERA Case XM for 15x 10 € collector coins Germany with polymer ring (incl. coin capsules).

☛ S2363-10EK



☛ 2363-12

☛ 2363-15

☛ S2363-10EK

NERA VARIUS PLUS

One for all - the VARIUS PLUS collection cases were developed for the NERA series to hold larger objects and collectibles. With an inside height of 60 mm and the light red or dark red inserts which are partly adjustable, VARIUS PLUS can be adjusted to fit your needs.

Format: 300 x 244 x 80 mm

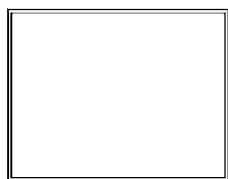

220 x 280 mm

● 2369-2401E

● 2369-2461E



● 2369-2417E

● 2369-2419E

● 2369-2418E

Foam insert with velvet-like surface to stick PINs / Medals/ Emblems.

These inserts have either 2 or 3 horizontal compartments and come with matching red dividers. You can customise each compartment and adjust the size any time to suit your needs.

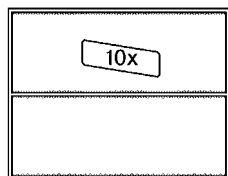

2x 105 x 280 mm

● 2369-2402E

● 2369-2462E

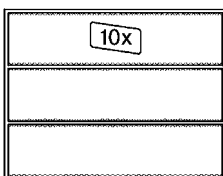

3x 65 x 280 mm

● 2369-2403E

● 2369-2463E



THE VERSATILE CASES:



NERA M

This case offers you the possibility of choosing different inserts from our large assortment of light red, dark red, dark blue or black coin box inserts.

Format: 298 x 243 x 35 mm

NERA Case M

2364-... (+ with insert of your choice*)

NERA M PLUS

NERA Case M PLUS - with window

2367-... (+ with insert of your choice*)



*Sketches of the most popular NERA case coin inserts as well as the available colours are illustrated here. Please quote the order-no. of the selected tray when placing your order.

Format: 285 x 225 mm

Coin trays with round compartments for single coins and coin sets:

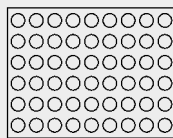

Ø 25,75 mm
2 €

- ...-2154E
- ...-2754E
- ...-2154ME
- ...-2154CE

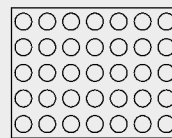

Ø 32,5 mm
20 €/10 €

- ...-2111E
- ...-2711E
- ...-2111ME
- ...-2111CE

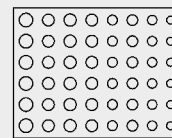

6x €-coin set

- ...-2506E
- ...-2906E
- ...-2506ME
- ...-2506CE



Coin trays with square or rectangular compartments:

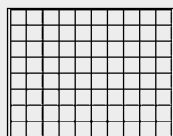

24 mm

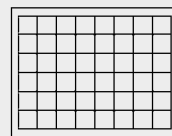

30 mm
champagne lids

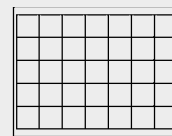

36 mm

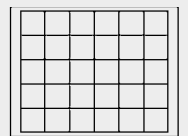

38 mm

- Velour insert red
- Velour insert dark red
- Velour insert dark blue
- Velour insert black

- ...-2180E
- ...-2780E
- ...-2180ME
- ...-2180CE

- ...-2148E
- ...-2748E
- ...-2148ME
- ...-2148CE

- ...-2135E
- ...-2735E
- ...-2135ME
- ...-2135CE

- ...-2115E
- ...-2715E
- ...-2115ME
- ...-2115CE

NERA XL

Our NERA XL with three trays was developed especially for larger collections and series. The single trays harmonize in colour and design with the case and allow for perfect stacking inside the case. You can choose between our wide assortment of light red, dark red, dark blue or black coin inserts.

Format: 310 x 255 x 82 mm

NERA Case XL

☛ 2365-... (+ with insert of your choice*)



☛ 2365-2226E



☛ 2365-2530ME



☛ 2365-2154CE



☛ 2365-2219E



☛ 2365-2122CE



Coin trays with round compartments for encapsulated coins and coin sets:

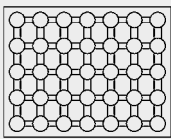

Ø 32 mm
2 € in LINDNER
coin capsules

- ...-2530E
- ...-2930E
- ...-2530ME
- ...-2530CE

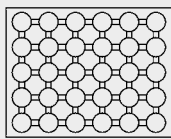

Ø 37,5 mm
20 €/10 € in
original capsules

- ...-2537E
- ...-2937E
- ...-2537ME
- ...-2537CE

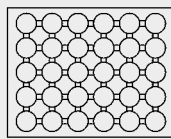

Ø 39,5 mm
20 €/10 € in LINDNER
coin capsules

- ...-2226E
- ...-2626E
- ...-2226ME
- ...-2226CE

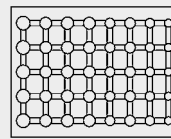

5x €-coin set
in LINDNER
coin capsules

- ...-2556E
- ...-2956E
- ...-2556ME
- ...-2556CE



☛ 2367-2530ME

☛ 2365-2748E

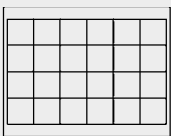

42 mm

- ...-2124E
- ...-2724E
- ...-2124ME
- ...-2124CE

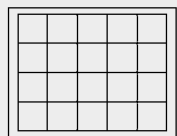

47 mm

- ...-2120E
- ...-2720E
- ...-2120ME
- ...-2120CE

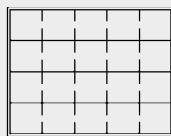

50 mm
OCTO/CARRÉE coin
capsules, Coin holders

- ...-2122E
- ...-2722E
- ...-2122ME
- ...-2122CE

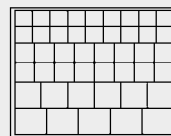

24, 28, 39, 44 mm

- ...-2145E
- ...-2745E
- ...-2145ME
- ...-2145CE

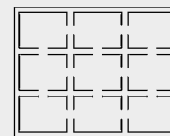

63 x 85 mm
Slabs

- ...-2219E
- ...-2619E
- ...-2219ME



SOLID WOOD CASE CARUS-1

SOLID WOOD CASE CARUS 1 WITH ONE VELOUR COIN INSERT

Solid wood case in a perfect, dark finish surface. The surface is smooth and shows the natural grain of the wood. The natural grain of the wood on the outside of the lid as well as the inner side enhances each case giving it an individual character. The appearance of each case is enhanced by the stable LINDNER-latch. The inserts are covered in high-quality dark red or dark blue velour.

Format: 303 x 240 x 30 mm

For thicker coins/ coin capsules from a height of 6,5 mm, we recommend collecting in CARUS-1 with d-Box inserts or in LINDNER d-Boxes (see page 10).

Available with blue inserts/trays too.

Made in Germany

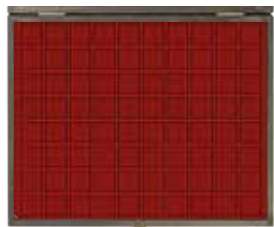

24 x 24 mm 80x

- S2491-2780E
- S2491-2180ME



36 x 36 mm 35x

- S2491-2735E
- S2491-2135ME

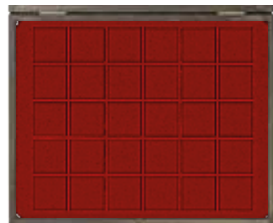

38 x 38 mm 30x

- S2491-2715E
- S2491-2115ME



42 x 42 mm 24x

- S2491-2724E
- S2491-2124ME



47 x 47 mm 20x

- S2491-2720E
- S2491-2120ME

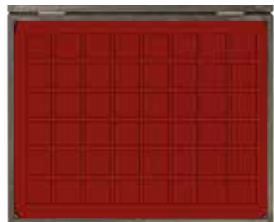

30 x 30 mm 48x

- S2491-2748E
- S2491-2148ME



50 x 50 mm 20x

- S2491-2722E
- S2491-2122ME



∅ 63 x 85 mm Slabs 9x

- S2491-2619E
- S2491-2219ME



∅ 25.75 mm 54x

- S2491-2754E
- S2491-2154ME

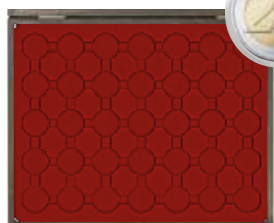

∅ 32 mm 35x

- S2491-2930E
- S2491-2530ME



∅ 32.5 mm 35x

- S2491-2711E
- S2491-2111ME

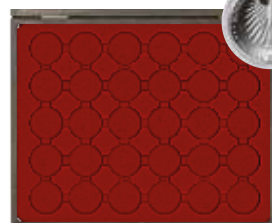

∅ 37.5 mm 30x

- S2491-2937E
- S2491-2537ME



6x €-coin set

- S2491-2906E
- S2491-2506ME

SOLID WOOD CASE CARUS-4

COMPACT CASE WITH LOTS OF SPACE – PURE WOOD CASE WITH 4 TRAYS AND VELOUR COIN INSERTS.

Pure wood – for LINDNER this means: authentic wood in a perfect, dark stained finish. The surface is very smooth and shows the natural grain of the wood. The wood trays inside have two indentations – one on each side – to remove or fill the trays more easily. Two durable latches are not only functional but also enhance the appearance of the coin case. The coin inserts are covered in high-quality dark red or dark blue velour.

Format: 325 x 265 x 65 mm

All cases one price!

With 4 different coin trays:

ASSORTEMENT:

- 47 x 47 mm 20x
- 42 x 42 mm 24x
- 36 x 36 mm 35x
- 30 x 30 mm 48x

- 2494-1
- 2494-1M

Available with blue inserts/trays too.

Made in Germany



With 4 identical coin trays:

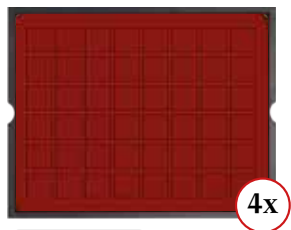

30 x 30 mm 48x

- 2494-6
- 2494-6M

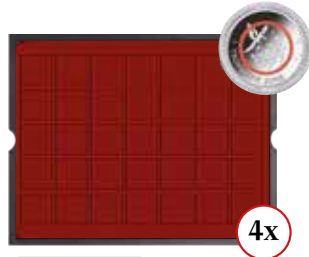

36 x 36 mm 35x

- 2494-5
- 2494-5M

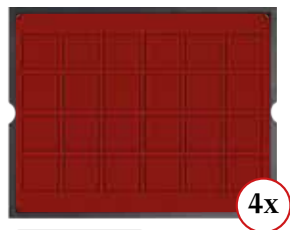

42 x 42 mm 24x

- 2494-4
- 2494-4M

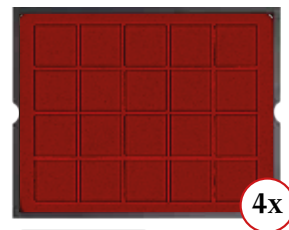

47 x 47 mm 20x

- 2494-2
- 2494-2M

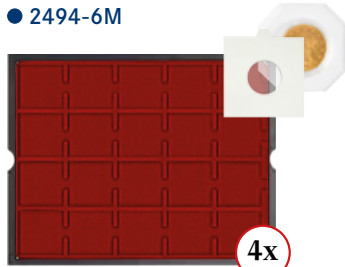

50 x 50 mm 80x

- 2494-3
- 2494-3M

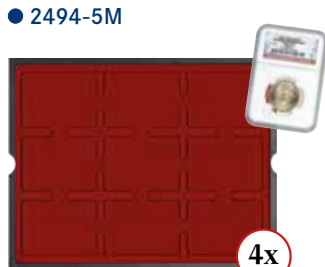

∅ 63 x 85 mm Slabs 36x

- 2494-19
- 2494-19M

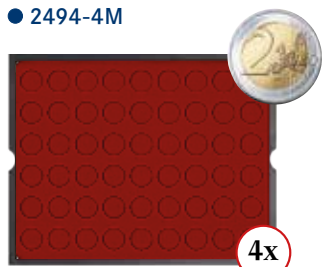

∅ 25.75 mm 216x

- 2494-10
- 2494-10M

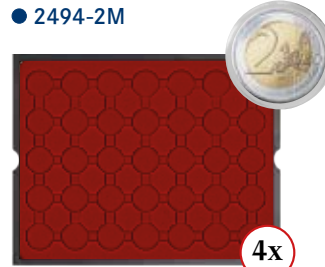

∅ 32.0 mm 140x

- 2494-11
- 2494-11M

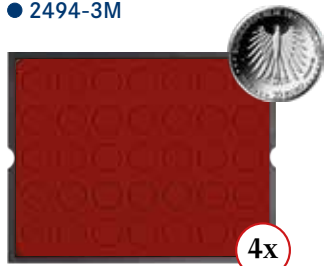

∅ 32.5 mm 140x

- 2494-7
- 2494-7M

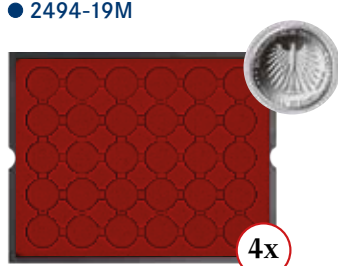

∅ 37.0 mm 120x

- 2494-9
- 2494-9M

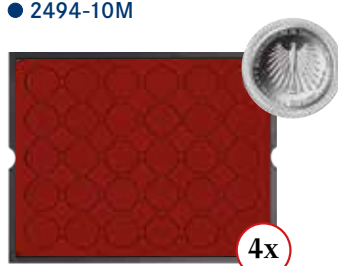

∅ 39.0 mm 120x

- 2494-8
- 2494-8M

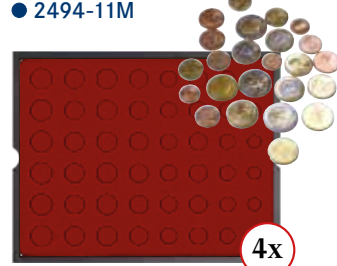

24x €-coin set

- 2494-12
- 2494-12M

SOLID WOOD COIN CASE

WITH 5 BLACK OR DARK BLUE INSERTS

Solid wood case in a perfect, dark finish surface. The surface is smooth and shows the natural grain of the wood. The natural grain of the wood on the outside of the lid as well as the inner side enhances each case giving it an individual character. The appearance of each coin case is enhanced by the stable LINDNER-latch. The coin inserts are covered in high-quality black or dark blue velour.

Format: 305 x 245 x 55 mm

Made
in
Germany



30 x 30 mm

- S2495-S2148CE
- S2495-S2148ME

240 square compartments
(5 inserts with each 48 compartments)

Suited for:
Coins/Coin capsules up to Ø 30 mm, e.g. for 2 €-coins or Champagne lids.



36 x 36 mm

- S2495-S2135CE
- S2495-S2135ME

175 square compartments
(5 inserts with each 35 compartments)

Suited for:
Coins/Coin capsules up to Ø 36 mm, e.g. for original encapsulated 20 €-/10 €-Silver coins Germany (proof) or 2 €-coins in LINDNER coin capsules (2250026P).



38 x 38 mm

- S2495-S2115CE
- S2495-S2115ME

150 square compartments
(5 inserts with each 30 compartments)

Suited for:
Coins/Coin capsules up to Ø 38 mm.



42 x 42 mm

- S2495-S2124CE
- S2495-S2124ME

120 square compartments
(5 inserts with each 24 compartments)

Suited for:
Coins/Coin capsules up to Ø 42 mm, e.g. for original encapsulated 20 €-/10 €-Silver coins Germany (proof) or for 20 €-/10 €-Silver coins Germany in rimless LINDNER Coin capsules (22600325P) or LINDNER Coin capsules (2250325P).



47 x 47 mm

- S2495-S2120CE
- S2495-S2120ME

100 square compartments
(5 inserts with each 20 compartments)

Suited for:
Coins/Coin capsules up to Ø 47 mm.



50 x 50 mm

- S2495-S2122CE
- S2495-S2122ME

100 square compartments
(5 inserts with each 20 compartments)

Suited for:
Coin holders 50 x 50 mm,
Coin capsules OCTO/CARRÉE.



PRESENTATION CASE ALU

Store your coins in a modern design. Case in noble aluminium design with black padded lining of the lid and black coin insert with square compartments.

The coin insert is covered with high-quality velour.

Format: 300 x 245 x 33 mm

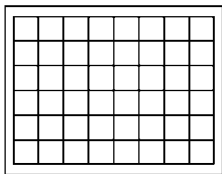

30 x 30 mm 48x
S2301-2148CE

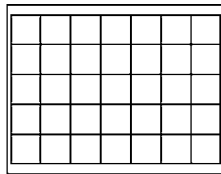

36 x 36 mm 35x
S2301-2135CE

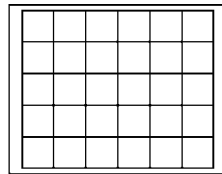

38 x 38 mm 30x
S2301-2115CE

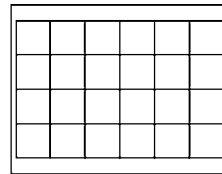

42 x 42 mm 24x
S2301-2124CE

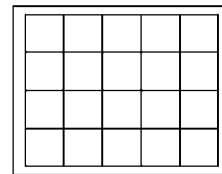

47 x 47 mm 20x
S2301-2120CE

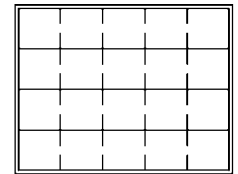

50 x 50 mm 20x
S2301-2122CE

NERA CASE M PLUS - WITH WINDOW

Timeless elegance, a clear design, versatility, functionality and most of all, a special touch – these are the magnificent features of our NERA series. Coin case with black, grained surface in leather optic and creme coloured stitching with window. The coin trays are covered with a high quality velour-like surface.

Format: 298 x 243 x 35 mm

Max. filling height: 18,5 mm

For larger and thicker coins/medals or other collectibles.

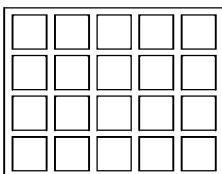

47 x 47 mm 20x
● 2367-2820E
● 2367-2870E

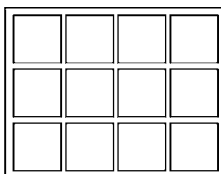

66 x 66 mm 12x
● 2367-2812E
● 2367-2862E

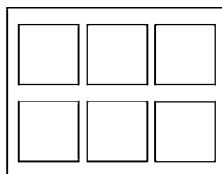

85 x 85 mm 6x
● 2367-2806E
● 2367-2856E

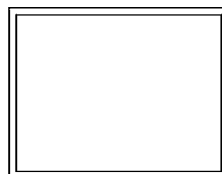

210 x 270 mm 1x
● 2367-2800E
● 2367-2850E

For more products of the NERA series, see page 24-27.

KARAT-COIN ALBUMS



Karat

Made in Germany

COIN ALBUM KARAT CLASSIC

For an attractive presentation, practical handling and safe storage of your coins. For many years collectors continue to choose the advantages of our karat-coin system.

High-quality padded ring binder made of padded synthetic foil. Equipped with 10 karat-coin pages (3x K2, 2x K3, 1x K4, 1x K5, 2x K6, 1x K8) and 10 red interleaves.

You can choose from two kinds of slipcases:

- slipcase made of cardboard with matching coloured cover material (Order no. 810D or complete album Order no. 1106E)
- slipcase made of synthetic with cut outs for easily removing of the ring binder (Order no. 810K or complete album Order no. 1106EK).

Format: 225 x 210 x 35 mm

Mechanism: 4-ring, 45/65/45 mm

Capacity: approx. 10 karat-coin pages

1106M - G	1106EK - G	1106E - G	1106Y - G	810K - G	810D - G
1106M - S	1106EK - S	1106E - S	1106Y - S	810K - S	810D - S
1106M - B	1106EK - B	1106E - B	1106Y - B	810K - B	810D - B
1106M - W	1106EK - W	1106E - W	1106Y - W	810K - W	810D - W

KARAT-COIN PAGES

Karat

The pages are easy to use and keep your coins safely in place. Simply remove the plastic strip from the page and insert the coins in the individual compartments. Once it is filled, insert the strip back into the page - that's it! The pages are easily removed, added or changed.

Material: Hard-PVC-foil (Insert strips)

Format: 188 x 210 mm

Scope of Delivery: 5 coin pages incl. interleaving pages

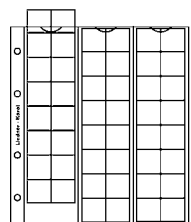

Made in Germany

Ø 22 mm 48x

Pack of 5
Interleaving pages white
K6W
Interleaving pages red
K6R

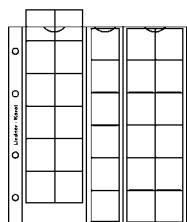

Made in Germany

Ø 30 mm 30x

Pack of 5
Interleaving pages white
K4W
Interleaving pages red
K4R

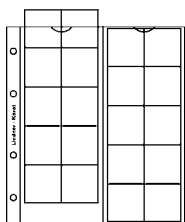

Made in Germany

Ø 38 mm 20x

Pack of 5
Interleaving pages white
K3W
Interleaving pages red
K3R

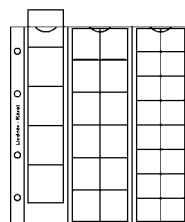

Made in Germany

Ø 38/30/22 mm 33x

Pack of 5
Interleaving pages white
K5W
Interleaving pages red
K5R

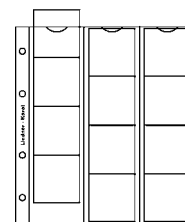

Made in Germany

Ø 48 mm 12x

Pack of 5
Interleaving pages white
K2W
Interleaving pages red
K2R

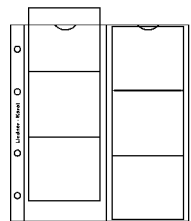

Made in Germany

Ø 65 mm 6x

Pack of 5
Interleaving pages white
K1W
Interleaving pages red
K1R

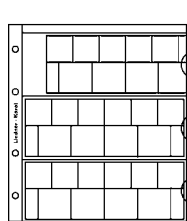

Made in Germany

Coin page incl. illustrated Euro coin set page suited for: 3 complete sets of € coins
Pack of 5
K8E

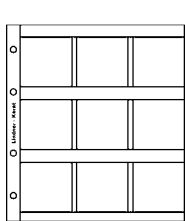

CTO

HARTBERGER®

Made in EU

50 x 50 mm 9x

Pack of 5
Interleaving pages white
K9W
Interleaving pages red
K9R



Made in Germany

Perforated colour flag-page for labeling the karat coin page K8 with the flags of the Euro-Countries. Country names in three languages: German, English and French.

15



Perforated colour flag-page for labeling the karat-coin page K8 with the flags of the new Euro-Countries and the rest of the European countries. Country names in three languages: German, English and French.

14

RING BINDER KARAT LEATHER

High-quality manufacturing, padded ring binder made of real leather.

Format: 225 x 210 x 35 mm

Mechanism: 4-ring, 45/65/45 mm

Capacity: approx. 10 karat-coin pages

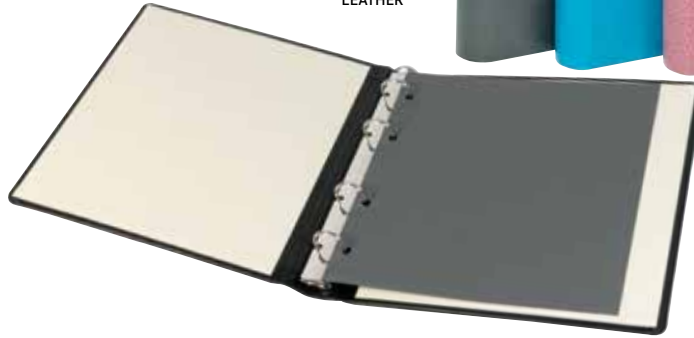

karat



1106L-G

1106L-S

1106L-B

1106L-H

1106L-W



karat

COIN ALBUM PUBLICA S

INCLUDING 5 COIN PAGES IN DIFFERENT SIZES

Padded ring binder PUBLICA S made of padded synthetic foil. The grained surface gives this ring binder its individual character. The spacious window on the spine offers space for listing of the content.

Comes with 5 karat-coin pages (K2, K3, K4, K5, K8) and 5 red interleaving pages.

Format: 225 x 240 x 60 mm

Mechanism: 4-ring, 45/65/45 mm

Capacity: approx. 25 coin pages depending on the size of the coins



S3520M

3520

KARAT BASIC COIN ALBUM

Album consists of ring binder in modern design including the matching slipcase and 5 karat-coin pages (K2, K3, K4, K5 and K8).

Material: Cardboard ring binder, covered

Format: 240 x 230 x 55 mm

Mechanism: 4-ring, 45/65/45 mm

Capacity: approx. 25 coin pages depending on the size of the coins

karat

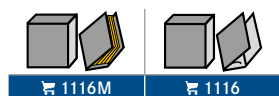

1116M

1116



KARAT ILLUSTRATED RING BINDER COIN-DESIGN, EMPTY

Padded karat-ring binder made of synthetic foil in coin-design.
Suitable for all LINDNER karat-coin pages.

Material Ring binder: Synthetic-foil, padded

Scope of Delivery: Ring binder, empty

Format: 210 x 230 x 35 mm

Mechanism: 4-ring, 45/65/45 mm

Capacity: approx. 10 karat-coin pages
incl. interleaving pages

KARAT 

Made
in
Germany



1115R

810D-S



ILLUSTRATED ALBUM EURO COLLECTION

Illustrated album for coin sets of all Euro-countries
(without Andorra, Monaco, San Marino, Vatican).

This album comes with 7 coloured illustrated
pages and 7 coin pages with hard-PVC-inserts for
3 €- coin sets each. Every single page allows
space for the current coin sets of three different
countries. One set of coins per country can be
stored on this page.

Scope of Delivery: Ring binder, 7 Euro-Collection
coin pages, 7 illustrated pages in colour,
(Order no. 8450-1 until 8450-42, see table on the
right), slipcase.

Format Ring binder: 250 x 270 x 60 mm

Mechanism: 4-ring, 45/65/45 mm

Capacity: approx. 15 coin pages

Single pages (Format: 200 x 250 mm)

All pages of this basic edition are also available
separately.

🛒	Illustrated page incl. coin page
8450-1	Belgium/Germany/Finland
8450-4	France/Greece/Ireland
8450-7	Italy/Luxembourg/Netherlands
8450-10	Austria/Portugal/Spain
8450-36	Slovenia/Malta/Cyprus
8450-39	Slovakia/Estonia/Latvia
8450-42	Lithuania/Croatia
8450-13*	Monaco/San Marino/Vatican
8450-0*	Neutral additional page without coin pictures

Single pages with commentary

For this album we also offer illustrated pages for
the new Euro countries with interesting informati-
on about the new coins and the country. In con-
trast to the basic edition we offer here one page
per country.

🛒	Illustrated page incl. coin page
8450-16	3 Coin sets Slovenia
8450-17	3 Coin sets Malta
8450-18	3 Coin sets Cyprus
8450-19	3 Coin sets Slovakia
8450-20	3 Coin sets Estonia
8450-21	3 Coin sets Latvia
8450-22	3 Coin sets Lithuania
8450-23	3 Coin sets Croatia

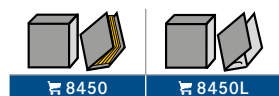

8450

8450L

Made
in
EU



General indications

- ▶ If needed all illustrated albums will be completed or extended. New and updated pages are available separately.

ILLUSTRATED COIN ALBUM FOR EURO COIN SETS

Illustrated album basic edition: Illustrated album for the current coin sets of all Euro countries (without Andorra, Monaco, San Marino and Vatican).

This album includes 7 coloured pages with illustrations of the current €-coin sets of the Euro countries, as well as 7 karat-coin pages with hard-PVC-inserts for 3 €-coin sets each. Every single page allows space for the current coin sets of three different countries. One set of coins per country can be stored on this page.

Material Ring binder: Synthetic-foil, padded

Scope of Delivery: Ring binder, 7 karat-coin pages K8, 7 illustrated pages in colour (Order no. 1108-1 until 1108-22, see table below)

Format: 210 x 230 x 35 mm

Mechanism: 4-ring, 45/65/45 mm

Capacity: approx. 10 coin pages



Made in Germany



ILLUSTRATED COIN ALBUM FOR EURO COIN SETS

Illustrated album basic edition: Illustrated album for the current coin sets of all Euro countries (without Andorra, Monaco, San Marino and Vatican).

This album includes 7 coloured pages with illustrations of the current €-coin sets of the Euro countries, as well as 7 karat-coin pages with hard-PVC-inserts for 3 Euro coin sets each. Every single page allows space for the current coin sets of three different countries. One set of coins per country can be stored on this page.

Material Ring binder: Laminated cardboard

Scope of Delivery: Ring binder, 7 karat-coin pages K8, 7 illustrated pages in colour (Order no. 1108-1 until 1108-22).

Format Ring binder: 230 x 240 x 55 mm

Mechanism: 4-ring, 45/65/45 mm

Capacity: approx. 15 coin pages

Single pages (Format: 188 x 210 mm)

All pages of this basic edition are also available separately.

🛒	Illustrated page incl. karat-coin page K8
1108-1	Belgium/Netherlands/Luxembourg
1108-2	Germany/Austria/France
1108-3	Finland/Ireland/Greece
1108-7	Italy/Spain/Portugal
1108-16	Slovenia/Malta/Cyprus
1108-19	Slovakia/Estonia/Latvia
1108-22	Lithuania/Croatia
1108-13*	Monaco/San Marino/Vatican

Single pages with commentary

For this album we offer also illustrated pages for the new Euro countries with interesting information about the new coins and the country. In contrast to the basic edition we offer here one page per country.

🛒	Illustrated page incl. karat-coin page K8
1109-16	Slovenia
1109-17	Malta
1109-18	Cyprus
1109-19	Slovakia
1109-20	Estonia
1109-21	Latvia
1109-22	Lithuania
1109-23	Croatia
1109-50	Change of ruler Netherlands
1109-51	Change of ruler Belgium
1109-52	Change of ruler Spain



Made in Germany



General indications

- ▶ If needed all illustrated albums will be completed or extended. New and updated pages are available separately.

ILLUSTRATED ALBUMS 2 EURO COMMEMORATIVE COINS

Illustrated album for 2 €-commemorative coins of all Euro-Countries in chronological order (without Andorra, Monaco, San Marino and Vatican). This album is based on our karat-system and can be supplemented with all karat-pages.

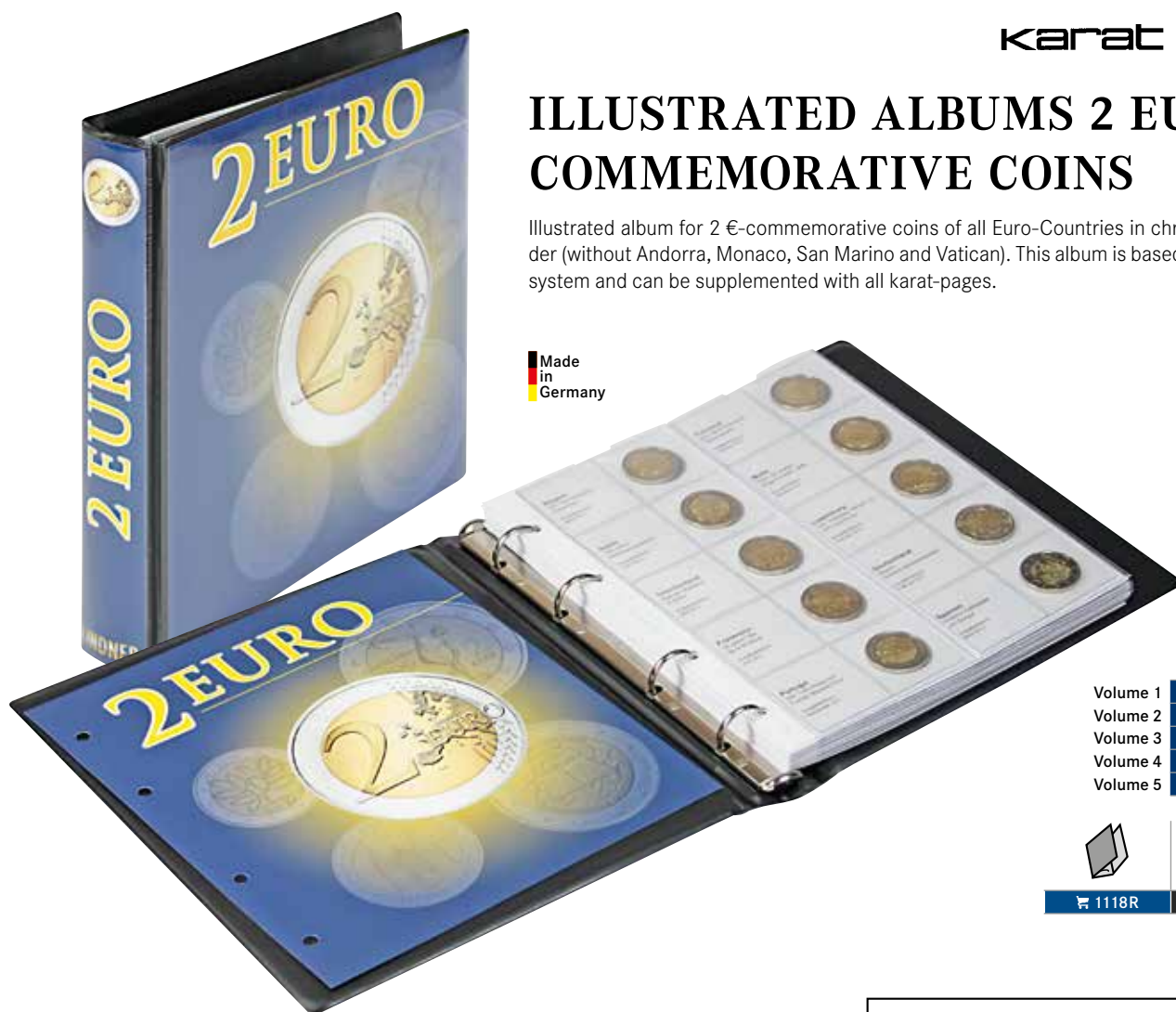

Made in Germany

- Volume 1  1118M
- Volume 2  1118M2
- Volume 3  1118M3
- Volume 4  1118M4
- Volume 5  1118M5

-  1118R
-  810D - S

Material Ring binder:

Synthetic-foil, padded

Format Ring binder: 210 x 230 x 35 mm

Mechanism: 4-ring, 45/65/45 mm

Capacity: approx. 10 coin pages

Volume 1  1118M

Greece 2004 until Spain 2012

Scope of Delivery: Ring binder, 9 karat-coin page K3, 9 illustrated pages (Order no. 1118-1 until 1118-9).

Volume 2  1118M2

Belgium 2012 until Finland 2016.

Scope of Delivery: Ring binder, 9 karat-coin page K3, 9 illustrated pages (Order no. 1118-10 until 1118-18).

Volume 3  1118M3

Lithuania 2016 until Malta 2019.

Scope of Delivery: Ring binder, 9 karat-coin page K3, 9 illustrated pages (Order no. 1118-19 until 1118-27).

Volume 4  1118M4

Latvia 2019 until Germany 2023.

Scope of Delivery: Ring binder, 9 karat-coin page K3, 9 illustrated pages (Order no. 1118-28 until 1118-36).

Volume 5  1118M5

Slovakia 2023 until Italy 2023.

Scope of Delivery: Ring binder, 1 karat-coin page K3, 1 illustrated page (Order no. 1118-37).

Single pages (Format: 188 x 210 mm)

All pages of this basic edition are also available separately.

	Illustrated page incl. karat-coin page K3
Volume 1	1118-1 Greece 2004 - Italy 2005
	1118-2 Italy 2006 - Germany 2008
	1118-3 Common Issue "Treaty of Rome"
	1118-4 Luxemburg 2008 - Portugal 2009
	1118-5 Common Issue "10 years Economic and Monetary Union"
	1118-6 Belgium 2009 - France 2010
	1118-7 Italy 2010 - Slovenia 2011
	1118-8 Common Issue "10 years €"
	1118-9 Belgium 2011 - Spain 2012
Volume 2	1118-10 Belgium 2012 - Germany 2013
	1118-11 Slovenia 2013 - Greece 2013
	1118-12 Greece 2013 - Portugal 2014
	1118-13 Slovakia 2014 - Greece 2014
	1118-14 Greece 2014 - Germany 2015
	1118-15 Common Issue „30 years European Flag“
	1118-16 Germany 2015 - France 2015
	1118-17 Italy 2015 - Lithuania 2015
	1118-18 Greece 2016 - Finland 2016

General indications

- ▶ If needed all illustrated albums will be completed or extended. New and updated pages are available separately.

Volume 3	1118-19 Lithuania 2016 - France 2016
	1118-20 Malta 2016 - Spain 2017
	1118-21 France 2017 - Lithuania 2017
	1118-22 France 2017 - Luxembourg 2017
	1118-23 Italy 2017 - Spain 2018
	1118-24 Spain 2018 - Portugal 2018
	1118-25 Italy 2018 - Luxembourg 2018
	1118-26 Germany 2019 - France 2019
	1118-27 Luxembourg 2019 - Malta 2019
Volume 4	1118-28 Latvia 2019 - France 2020
	1118-29 Luxembourg 2020 - Portugal 2020
	1118-30 Portugal 2020 - Slovenia 2020
	1118-31 Cyprus 2020 - Lithuania 2021
	1118-32 Portugal 2021 - Latvia 2021
	1118-33 Belgium 2021 - Estonia 2022
	1118-34 Spain 2022 - Luxembourg 2022
	1118-35 Common Issue "35 years Erasmus-Program"
	1118-36 Greece 2022 - Germany 2023
	1118-37 Slovakia 2023 - Italy 2023

The following pages will be available later (as soon as the coin motifs are known):

1118-38	
---------	--

ILLUSTRATED ALBUM 2 EURO COMMEMORATIVE COINS: SERIES "GERMAN FEDERAL STATES"

Illustrated album basic edition: From 2023 to 2028, each German federal state will issue its own 2€ commemorative coin. On the illustrated pages, the coins are shown with all 5 mint letters.

Scope of Delivery: Ring binder, 1 karat-coin page K3, 1 illustrated page (Order no. 1114-1).

Material Ring binder:

Synthetic-foil, padded

Format Ring binder: 210 x 230 x 35 mm

Mechanism: 4-ring, 45/65/45 mm

Capacity: approx. 10 coin pages



Single pages (Format: 188 x 210 mm)

All pages of this basic edition are also available separately.

	Illustrated page incl. karat-coin page K3
1114-1	2023 Hamburg / Elbphilharmonie

The following pages will be available later (as soon as the coin motifs are known):

1114-2	2024 Mecklenburg-Vorpommern / Königsstuhl
1114-3	2025 Saarland / Saarschleife



Made in Germany



General indications

- ▶ If needed all illustrated albums will be completed or extended. New and updated pages are available separately.

ILLUSTRATED ALBUM 20 EURO SILVER COINS: GERMANY

Illustrated album basic edition based on our karat-system with coin illustrations in black/white for chronological storage of 20 €-Silver coins of the Federal Republic of Germany.

Scope of Delivery: Ring binder, 8 karat-coin pages K2, 8 illustrated pages in colour (Order no. 1520-16 until 1520-23).

Material Ring binder:

Synthetic-foil, padded

Format Ring binder: 210 x 230 x 35 mm

Mechanism: 4-ring, 45/65/45 mm

Capacity: approx. 10 coin pages



Single pages (Format: 188 x 210 mm)

All pages of this basic edition are also available separately.

	Illustrated page incl. karat-coin page K2
1520-16	Germany 2016
1520-17	Germany 2017
1520-18	Germany 2018
1520-19	Germany 2019
1520-20	Germany 2020
1520-21	Germany 2021
1520-22	Germany 2022
1520-23	Germany 2023

The following pages will be available later (as soon as the coin motifs are known):

1520-24	Germany 2024
---------	--------------

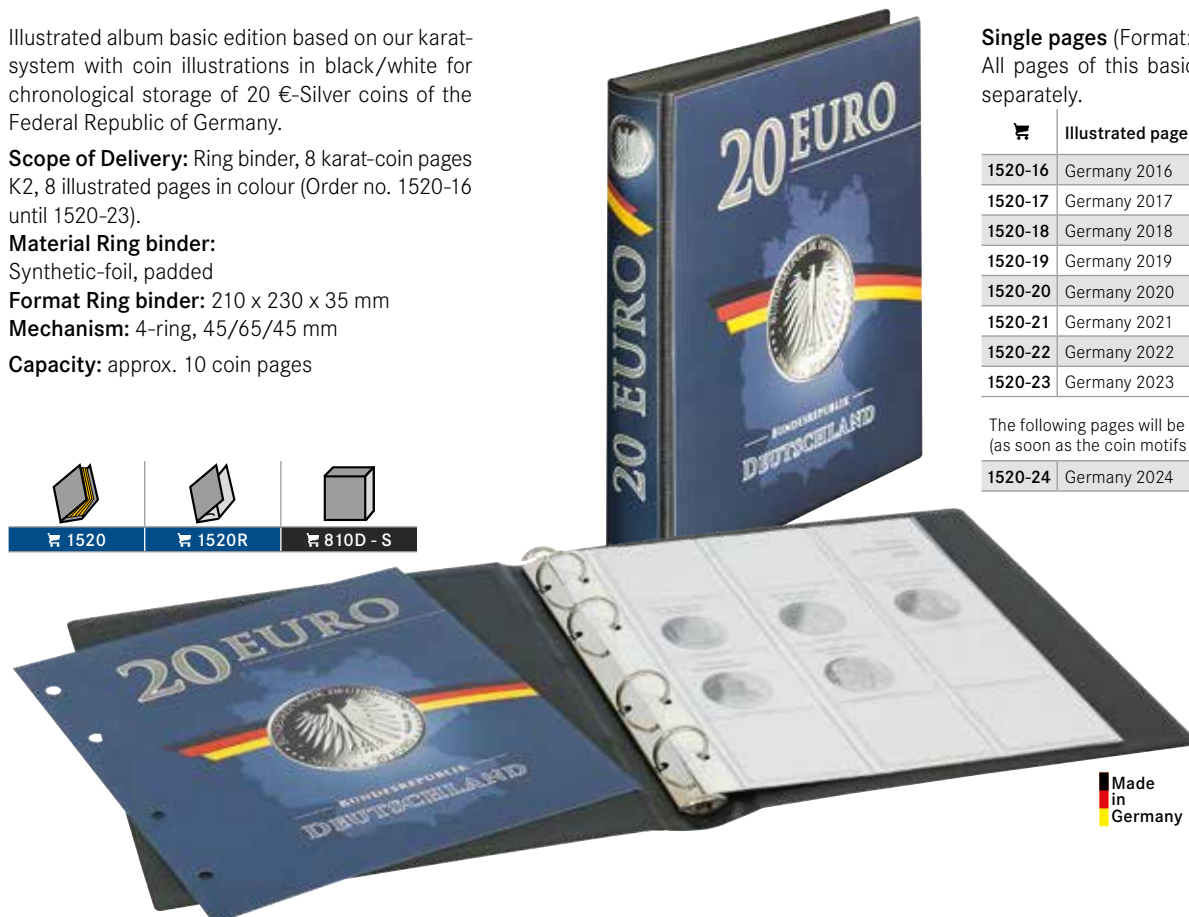

Made in Germany

ACCESSORIES FOR 5 EURO COLLECTORS COINS GERMANY

COIN CAPSULES
Coin capsules 27,5 mm,
Suited for 5 € Germany.



PACK OF 10 PACK OF 100
 € 2250275P € 2251275

NERA S
NERA Case S for 5x 5 € collector coins
Germany (incl. coin capsules). (see page 24)



NERA S
 ● S2362-5EK

NERA M
NERA Case M incl.
30 coin capsules.



NERA M
 ● S2364BS-2K

CARUS-1
Solid Wood Case
CARUS 1 incl.
30 coin capsules.



CARUS-1
 ● S2491BS-2K

Made in Germany

COIN BOX
Coin boxes incl.
30 coin capsules.



COIN BOX SMOKED GLASS
 ● S2933-2K

COIN BOX STANDARD
 ● S2533-2K

Made in Germany

ILLUSTRATED ALBUM 5 EURO COLLECTOR COINS: GERMANY



Illustrated album edition based on our karat-system with colourful coin illustrations for chronological storage of 5 €-collector coins Germany (all 5 mints).

Scope of Delivery: Ring binder, 4 karat-coin page K3, 4 illustrated pages (Order no. 1119-1 until 1119-4)

Material Ring binder:

Synthetic-foil, padded

Format Ring binder: 210 x 230 x 35 mm

Mechanism: 4-ring, 45/65/45 mm

Capacity: approx. 10 coin pages

Single pages (Format: 188 x 210 mm)

All pages of this basic edition are also available separately.

€	Illustrated page incl. karat-coin page K3
1119-1	Germany 2016 (Planet Erde) - 2017 (Tropische Zone)
1119-2	Germany 2018 (Subtropische Zone) - 2019 (Gemäßigte Zone)
1119-3	Germany 2020 (Subpolare Zone) - 2021 (Polare Zone)
1119-4	Germany 2022-2024 (Wunderwelt Insekten)



General indications

- ▶ If needed all illustrated albums will be completed or extended. New and updated pages are available separately.

ACCESSORIES FOR 10 EURO COLLECTORS COINS GERMANY

NERA S
NERA Case S for 5x 10 € collector coins Germany with polymer ring (incl. coin capsules). (see page 24)



NERA S
● S2362-10EK

NERA XM
NERA Case XM for 15x 10 € collector coins Germany with polymer ring (incl. coin capsules). (see page 25)



NERA XM
● S2363-10EK

COIN CAPSULES
Coin capsules 29 mm, suited for 10 € collector coins Germany.



PACK OF 10 PACK OF 100
🛒 2250029P 🛒 2251029

COIN BOX
Coin box for 42x 10 € collector coins Germany with polymer ring.



● 2105
● 2705

Made in Germany

COIN BOX
Coin box for 35x 10 € collector coins Germany with polymer ring.



● 2225
● 2625
🛒 2250029P

Made in Germany

ILLUSTRATED ALBUM 10 EURO COLLECTOR COINS WITH POLYMER RING: GERMANY



Illustrated album edition based on our karat-system with colourful coin illustrations for chronological storage of 10 €-collector coins Germany with polymer ring (all 5 mints).

Scope of Delivery: Ring binder, 6 karat-coin page K3, 6 illustrated pages (Order no. 1110-1 until 1110-6).

Material Ring binder: Synthetic-foil, padded

Format Ring binder: 210 x 230 x 35 mm

Mechanism: 4-ring, 45/65/45 mm

Capacity: approx. 10 coin pages

Single pages (Format: 188 x 210 mm)

All pages of this basic edition are also available separately.

🛒	Illustrated page incl. karat-coin page K3
1110-1	Germany 2019 (In der Luft)
1110-2	Germany 2020 (An Land)
1110-3	Germany 2021 (Auf dem Wasser)
1110-4	Germany 2022 (Pflege)
1110-5	Germany 2023 (Feuerwehr)
1110-6	Germany 2024 (Polizei)



General indications

- ▶ If needed all illustrated albums will be completed or extended. New and updated pages are available separately.

MULTI COLLECT - SYSTEM

VERSATILE COLLECTING WITH OUR MULTI-TALENTED SYSTEM

Versatile collecting with our multi-purpose album system. This album rightly deserves its name – every collector can find a large assortment of pages with a wide variety of pocket sizes which provides different types of collections.

Whether you collect stamps, sheetlets, FDCs, ETBs, year books, booklets, postcards, banknotes, coins or phone cards: Our Multi collect-system has a place for everything! The typical 4-ring mechanism of the padded Multi collect-ring binder guarantees easy handling and impresses with a large capacity. A plastic window on the spine provides space for identification labels/description of contents.

We offer ring binders which differ in size, colour and storage capacity.

Fitting ring binders are found on page 42-43.



BLANK PAGES

With 4-ring perforation
 Size PUBLICA M: 210 x 255 mm
 Material: 200 g/qm



Blank pages
 210 x 255 mm

€ 803o
 (Pack of 10)



1 pocket
 190 x 253 mm

Pack of 10
 ● MU1311
 ○ MU1321

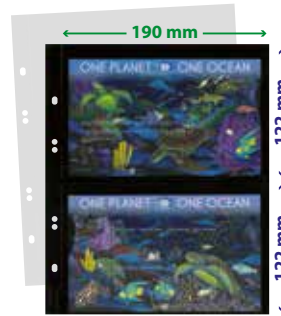

2 strips
 190 x 122 mm

Pack of 10
 ● MU1312
 ○ MU1322

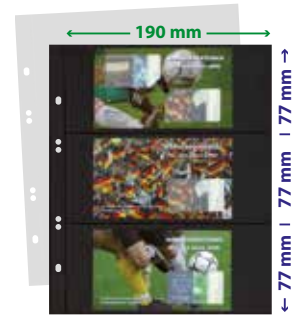

3 strips
 190 x 77 mm

Pack of 10
 ● MU1313
 ○ MU1323

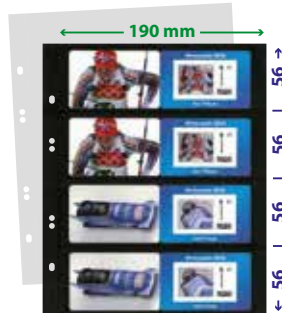

4 strips
 190 x 56 mm

Pack of 10
 ● MU1314
 ○ MU1324



5 strips
 190 x 43 mm

Pack of 10
 ● MU1315
 ○ MU1325

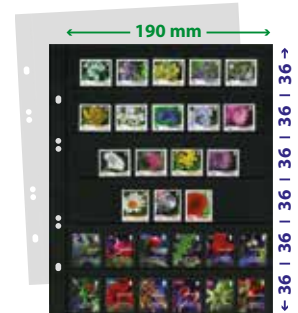

6 strips
 190 x 36 mm

Pack of 10
 ● MU1316
 ○ MU1326



2 vertical strips
 91 x 253 mm

Pack of 10
 ● MU1317

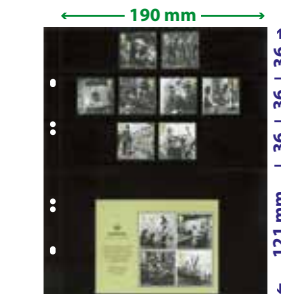

4 strips
 190 x 36 mm (3x)
 190 x 121 mm (1x)

Pack of 10
 ● MU1319



1 pocket
 151 x 235 mm

Pack of 10
 ● MU1330
 ○ MU1340



2 strips
 152 x 112 mm

Pack of 10
 ● MU1331
 ○ MU1341

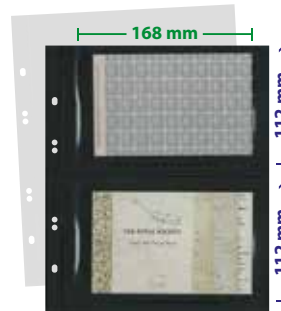

2 strips
 168 x 112 mm

Pack of 10
 ● MU1332
 ○ MU1342

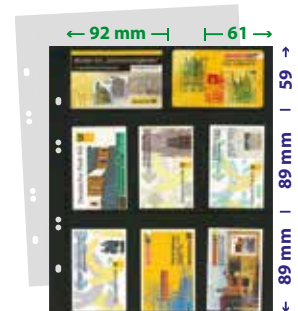

8 pockets
 92 x 59 mm (2x)
 61 x 89 mm (6x)

Pack of 10
 ● MU1353
 ○ 1363* 2)

*Delivery only while stocks last. 2) Suited for Ring binder €1300 and €1400

Delivery do not include contents / display material. All specifications are subject to change without prior notice.

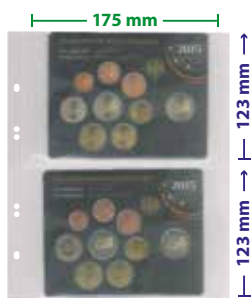

2 pockets
175 x 123 mm
2 sets Euro-coins Germany
proof
Pack of 10
● MU1363



8 pockets
93 x 56 mm
REBECK COIN L Coin holders/
Telephone cards,
Coin-Cards
Pack of 10
● MU1364



1 pocket
180 x 207 mm
current coin sets in blister
Pack of 10
● MU1392

MULTI COLLECT-PAGES

The **one-sided**, crystal clear Multi collect-pages are made of softener and acid-free hard-PVC-foil. You can view the front and back of the items that are placed in these pages.

The **double-sided**, black Multi collect-pages are made of archival safe hard-PVC, that is free of acids and chemical softeners to ensure long term preservation and presentation.

Format: 210 x 255 mm



1 pocket
185 x 250 mm
one pocket with black insert
Pack of 10
● MU1405



2 pockets
185 x 120 mm
two pockets with black inserts
Pack of 10
● MU1404



3 pockets
185 x 80 mm
three pockets with black inserts
Pack of 10
● MU3103

MULTI COLLECT-PAGES FOR BANKNOTES

The Multi collect-pages made of crystal-clear, softener and acid-free hard-PVC-foil with black foil insert strips can be filled twice. The foil insert strips are removable. This offers the possibility to fill the pockets with just one receipt and the front and back of the contents can be viewed.

Format: 210 x 255 mm



12 pockets Ø 50 mm
Pack of 5
Interleaving black
● MU12 ³⁾
Interleaving red
● MU12R ³⁾



15 pockets Ø 42 mm
Pack of 5
Interleaving black
● MU15
Interleaving red
● MU15R



24 pockets Ø 34 mm
Pack of 5
Interleaving black
● MU24
Interleaving red
● MU24R

MULTI COLLECT-COIN PAGES

Our **crystal clear Multi collect-coin pages** provide neat and safe storage of your coin collection. Simply remove the plastic strip from the page and insert the coins in the individual compartments. Once it is filled, insert the strip back into the page. The pages are easily removed, added or changed.

Format: 202 x 252 mm

³⁾Made in EU



35 pockets Ø 27 mm
Pack of 5
Interleaving black
● MU35
Interleaving red
● MU35R



5x €-coin set
Pack of 5
Interleaving black
● MU40
Interleaving red
● MU40R



54 pockets Ø 20 mm
Pack of 5
Interleaving black
● MU54
Interleaving red
● MU54R

INTERLEAVING PAGES

(Format: 210 x 255 mm)

Interleaves are recommended for interleaving purposes.

Pack of 20, crystal clear
● MU1385

Interleaving black

Pack of 5
● MUZ
Pack of 10
● MU1386

Interleaving red
Pack of 5
● MUZR

MULTI COLLECT-RING BINDER REGULAR CLASSIC

CLASSIC

Padded ring binder made of padded synthetic-foil. The grained surface in leather-effect gives the ring binder its individual character. The typical 4-ring mechanism of the Multi collect-ring binder guarantees a simple handling and the ring binder impresses with its large capacity. The generous spine window offers space for content listing. Matching pages see page 40-41.

Format Ring binder: 245 x 270 x 80 mm

Format Ring binder incl. Slipcase: 250 x 280 x 85 mm

Mechanism: 4-ring, 40/80/40 mm



1302 - G	1300 - G	1301 - G
1302 - S	1300 - S	1301 - S
1302 - B	1300 - B	1301 - B
1302 - H	1300 - H	1301 - H
1302 - W	1300 - W	1301 - W



Capacity:

approx. 20 Multi collect-coin pages
 approx. 60 Multi collect-stockpages – black
 approx. 80 Multi collect-stockpages – crystal clear



3515R

PUBLICA M RING BINDER COIN-DESIGN

Padded PUBLICA M-Ring binder made of padded synthetic-foil in coin-design.

Suitable for all LINDNER Multi collect-coin pages with universal perforation.

Format Ring binder: 245 x 270 x 60 mm

Mechanism: 4-ring, 45/65/45 mm

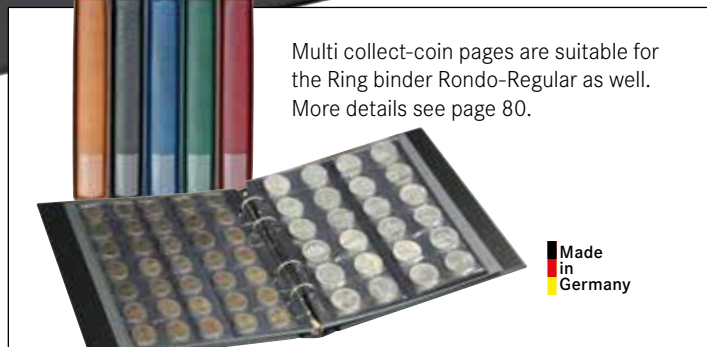

Multi collect-coin pages are suitable for the Ring binder Rondo-Regular as well. More details see page 80.



Capacity:

approx. 15 Multi collect-coin pages

RING BINDER PUBLICA M



The large capacity enhances the modern and fresh appearance of these high-quality, padded ring binders. The robust and sturdy material used to produce these, guarantee an extensive durability of this ring binder. The standard mechanism allows it to be used universally. A pocket on the inside of the ring binder offers room for content labelling. Matching pages see page 40-41.

Format Ring binder: 245 x 270 x 60 mm
Format Ring binder incl. Slipcase: 250 x 280 x 75 mm
Mechanism: 4-ring, 45/65/45 mm

Capacity:
 approx. 15 Multi collect-coin pages
 approx. 50 Multi collect-stockpages – black
 approx. 70 Multi collect-stockpages – crystal clear



Made in Germany

S3542M - 1	S3542 - 1
S3542M - 9	S3542 - 9
S3542M - 5	S3542 - 5
S3542M - 4	S3542 - 4
S3542M - 13	S3542 - 13

PUBLICA M COLOR COIN ALBUM WITH 10 COIN PAGES

PUBLICA M COLOR ring binder, equipped with 10 crystal clear Multi collect-pages in 5 variations (2 x MU15, 2 x MU24, 2 x MU35, 2 x MU40, 2 x MU54) for over 300 coins. The high-quality coin pages with transparent, softener-free slider inserts allow for a safe and practical storage of your coins. The characteristic slider insert system guarantees an especially practical functionality. You can easily remove, replace and exchange whole series. The coin pages are divided by black cardboard interleaves.



Made in Germany



RING BINDER PUBLICA M A SPACE-SAVING, SAFE AND ATTRACTIVE RING BINDER FOR COINS AND BANKNOTES

The high-quality ring binder from the PUBLICA series offers a uniform, classical and timeless design. The sturdy construction and the quality materials selected for this ring binder guarantee many years of use. The padded leatherette cover has a 4-ring mechanism and is also available with a matching slipcase. A large, clear index window on the spine allows you to insert a description for easy identification of the contents. Matching pages see page 40-41.

The sturdy slipcase, that is optionally available, protects the album and its contents. It stands safely on the shelf or cupboard.

Format Ring binder: 245 x 270 x 60 mm
Format Ring binder incl. Slipcase: 250 x 280 x 75 mm
Mechanism: 4-ring, 45/65/45 mm

Capacity:
 approx. 15 Multi collect-coin pages
 approx. 50 Multi collect-stockpages – black
 approx. 70 Multi collect-stockpages – crystal clear

COIN ALBUM PUBLICA M INCL. 10 COIN PAGES

PUBLICA M ring binder comes with 10 transparent Multi collect-coin pages (2x MU15, 2x MU24, 2x MU35, 2x MU40, 2x MU54) to hold over 300 coins. Our crystal clear coin pages provide neat and safe storage of your coin collection. Simply remove the plastic strip from the page and insert the coins in the individual compartments. Once it is filled, insert the strip back into the page. The pages are easily removed, added, or changed. The coin pages are separated by black interleaving pages which provide a nice background for the coins.

3532 - G	3530 - G	3531 - G	3532M - G
3532 - S	3530 - S	3531 - S	3532M - S
3532 - B	3530 - B	3531 - B	3532M - B
3532 - H	3530 - H	3531 - H	3532M - H
3532 - W	3530 - W	3531 - W	3532M - W

PUBLICA M ILLUSTRATED ALBUM

2 EURO COINS



Illustrated album with coloured illustrations for all 2 € commemorative coins of all Euro countries (without Andorra, Monaco, San Marino and Vatican) in chronological order. All “common issues” are also included.

Material Ring binder: Synthetic-foil, padded

Format Ring binder: 270 x 245 x 60 mm

Mechanism: 4-ring, 45/65/45 mm

Capacity: approx. 15 coin pages

Choose between album with slipcase and album without slipcase.



Volume 1	3535E	3535M
Volume 2	3535E2	3535M2
Volume 3	3535E3	3535M3



3535R 3531-S

Volume 1 3535M

Greece 2004 to France 2015

Scope of Delivery: Ring binder, 14 Multi collect-coin illustrated pages (Order no. MU2E1 until MU2E14).

Volume 2 3535M2

Italy 2015 to Slovenia 2022

Scope of Delivery: Ring binder, 14 Multi collect-coin illustrated pages (Order no. MU2E15 until MU2E28).

Volume 3 3535M3

Germany 2022 to Spain 2023

Scope of Delivery: Ring binder, 4 Multi collect-coin illustrated pages (Order no. MU2E29 until MU2E32).

General indications

- ▶ If needed all illustrated albums will be completed or extended.

New and updated pages are available separately.

Single pages (Format: 210 x 255 mm)

All pages of this basic edition are also available separately.

	Illustrated page incl. Multi collect-coin page MU24
Volume 1	MU2E1 Greece 2004 - Belgium 2006
	MU2E2 Luxemburg 2006 - France 2008
	MU2E3 Common Issue "Treaty of Rome"
	MU2E4 Portugal 2008 - Luxemburg 2010
	MU2E5 Common Issue "10 Years Economic and Monetary Union"
	MU2E6 Spain 2010 - Luxemburg 2011
	MU2E7 Spain 2011 - Spain 2012
	MU2E8 Common Issue "10 Years Euro"
	MU2E9 Belgium 2012 - The Netherlands 2013
	MU2E10 Spain 2013 - Finland 2013
	MU2E11 The Netherlands 2013 - Malta 2014
	MU2E12 Italy 07/2014 - Italy 12/2014
	MU2E13 Common Issue "30 Years European Flag"
	MU2E14 Spain 2014 - France 2015
Volume 2	MU2E15 Italy 2015 - Austria 2016
	MU2E16 Estonia 2016 - Belgium 2016
	MU2E17 Slovenia 2016 - Greece 2016
	MU2E18 Slovakia 2017 - Greece 2017
	MU2E19 Portugal 2017 - Luxembourg 2017
	MU2E20 Italy 2017 - Estonia 2018
	MU2E21 France 2018 - Finland 2018
	MU2E22 France 2018 - Belgium 2019
	MU2E23 Estonia 2019 - Germany 2019
	MU2E24 France 2019 - France 2020
	MU2E25 Luxembourg 2020 - Belgium 2020
	MU2E26 France 2020 - Luxembourg 2021
	MU2E27 France 2021 - Finland 2021
	MU2E28 Lithuania 2021 - Slovenia 2022
Volume 3	MU2E29 Germany 2021 - Luxembourg 2022
	MU2E30 Common Issue „35 Years Erasmus-program“
	MU2E31 Greece 2022 - Lithuania 2023
	MU2E32 Italy 2023 - Spain 2023
MU2E33	

The following pages will be available later (as soon as the coin motifs are known):

MU2E33



Made in Germany



PUBLICA M ILLUSTRATED ALBUM 20 EURO SILVER COINS GERMANY

Illustrated album with coin illustration in black/white for chronological storage of 20 €-Silver coins Germany.

Scope of Delivery: Ring binder, 8 Multi collect-coin pages and 8 illustrated pages (MU20E16 until MU20E23).

Single pages (Format: 210 x 255 mm)
All pages of this basic edition are also available separately.

General indications

- ▶ If needed all illustrated albums will be completed or extended.

New and updated pages are available separately.

Material Ring binder: Synthetic-foil, padded
Format Ring binder: 270 x 245 x 60 mm
Mechanism: 4-ring, 45/65/45 mm
Capacity: approx. 15 coin pages

	Illustrated page incl. Multi collect-coin page MU15
MU20E16	20 € Silver coins Germany 2016
MU20E17	20 € Silver coins Germany 2017
MU20E18	20 € Silver coins Germany 2018
MU20E19	20 € Silver coins Germany 2019
MU20E20	20 € Silver coins Germany 2020
MU20E21	20 € Silver coins Germany 2021
MU20E22	20 € Silver coins Germany 2022
MU20E23	20 € Silver coins Germany 2023

The following pages will be available later (as soon as the coin motifs are known):

MU20E24	20 € Silver coins Germany 2024
---------	--------------------------------

Made in Germany

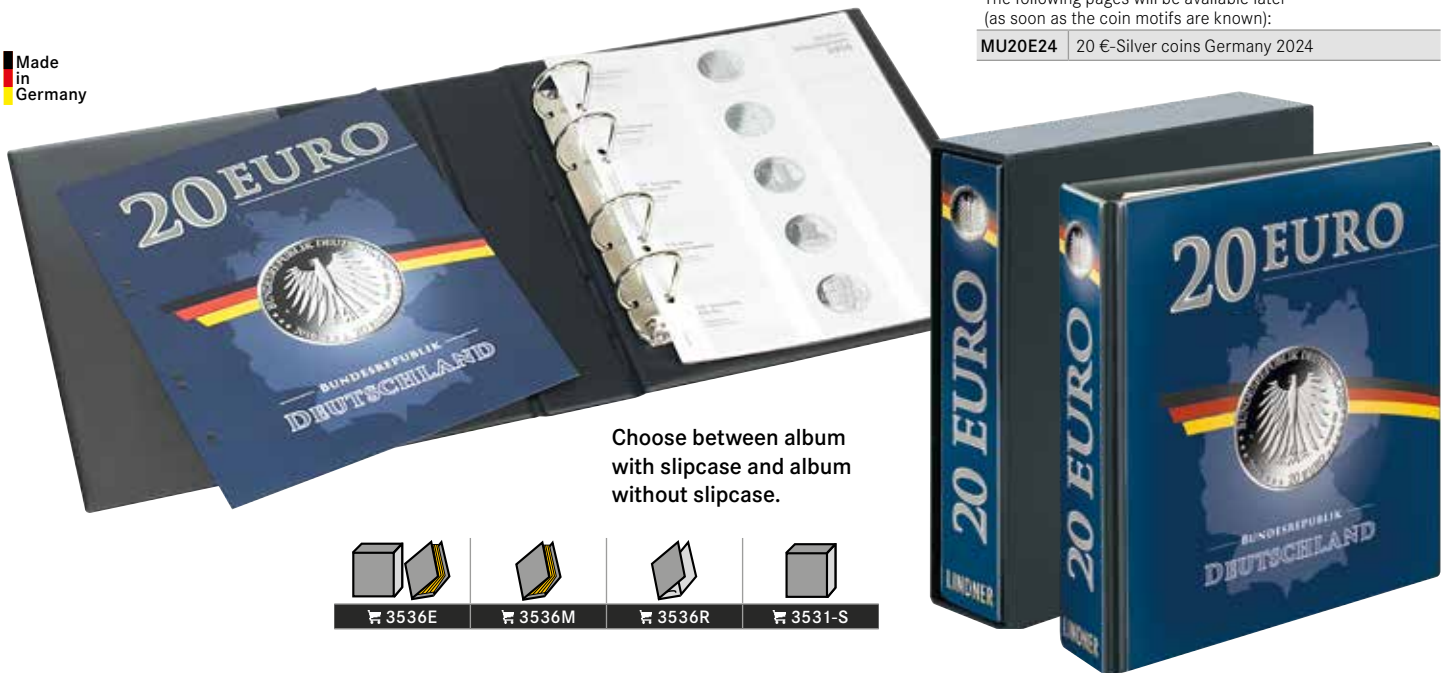

Choose between album with slipcase and album without slipcase.



"HALF PENNY" RING BINDER

Ring binder made of padded synthetic-foil, with Half Penny print on the cover. Comes with 10 Multi collect-coin pages (2x MU15R, 2x MU24R, 2x MU35R, 2x MU40R, 2x MU54R) and 10 red interleaves.

Matching pages see page 40-41.

Format: 235 x 270 x 40 mm

Mechanism: 4-ring, 45/65/45 mm

Capacity:
approx. 12 coin pages



3107 - G	3109 - G
3107 - S	3109 - S
3107 - B	3109 - B
3107 - H	3109 - H
3107 - W	3109 - W
3107 - D	3109 - D



Made in Germany

COIN CASE

WITH BLUE VELOUR
INSERT FOR ALL
COMMON COINS

Format: 70 x 70 x 15 mm
Material: Synthetic, blue





Coin case incl. patented form-adaptive insert
Blue push-in foam insert into which the coin can be pressed.

Ø 50 mm

Format: 65 x 65 x 15 mm
Material: Synthetic, blue
€ 2027



Coin case
Blue velour insert with square compartment and one synthetic coin envelope.

Ø 40 mm

Format: 75 x 75 x 12 mm
Material: Synthetic, blue
€ 2020



Coin Case with blue velour insert with three stages
with coin insert with three stages 30/40/50 mm.

NEW!

Ø 30/40/50 mm

Format: 75 x 75 x 20 mm
€ 2028



Coin case for one Euro coin set
This attractive case holds one complete coin set from 1 Cent to 2 €.

Format: 90 x 90 mm
Material: Synthetic, blue
€ 2026



Made in Germany

Coin envelopes made of crystal clear synthetic material
Material: PVC film acid-free, not completely plasticizer-free

Ø 46 mm

Format: 50 x 50 mm
€ 2051 (Pack of 100)
€ 2050 (Pack of 500)

Ø 60 mm

Format: 64 x 64 mm
€ 8476 (Pack of 100)
€ 8477 (Pack of 500)

Special production on request.



Poly bags with press-lock
with approx. 20 mm flap. Material: LPDE film. Packaging unit: Pack of 100

€	
780	40 x 60 mm
781	60 x 80 mm
782	70 x 100 mm
783	80 x 120 mm
784	100 x 150 mm
785	120 x 170 mm
786	160 x 220 mm
787	180 x 250 mm
788	220 x 310 mm
789	300 x 400 mm



Blue velour insert with round compartment and one capsule which features red adjustable distance rings. The rings can be adjusted to the size of the coin.

Material: Synthetic, blue

Small Coin Case with capsules

Ø 16-39 mm

Format: 60 x 60 x 20 mm
€ 2002

Large Coin Case with capsules

Ø 16-51 mm

Format: 80 x 80 x 23 mm
€ 2003



Blue velour insert with round hollow.

Material: Synthetic, blue

Small Coin Cases

Ø 41 mm

Format: 60 x 60 x 20 mm
€ 2006

Large Coin Case

Ø 60 mm

Format: 80 x 80 x 20 mm
€ 2007



Made in Germany

Labelling cards
Suitable for Coin envelopes 2050/2051
Format: 45 x 45 mm
€ 802005 (Pack of 100)

Coin envelopes made of crystal clear synthetic material incl. labelling cards
€ 2051-802005 (Pack of 100)



Made in Germany

Double coin envelope can be folded together
Opening is on the inside.
Material: PVC film acid-free, not completely plasticizer-free.



Made in Germany

Sleeve made from crystal clear synthetic-foil to hold one complete Euro coin set
Made from crystal clear synthetic-foil.
Format: 170 x 67 mm
€ K7ES (Pack of 100)



Made in Germany

Coin envelopes made of acid-free, white paper

Ø 46 mm

Format: 50 x 50 mm
€ 2053 (Pack of 100)
€ 2052 (Pack of 1000)

Ø 66 mm

Format: 70 x 70 mm
€ 8473 (Pack of 100)
€ 8472 (Pack of 1000)

Special production on request.

Double coin envelope can be folded together
Opening is on the inside.
Material: PVC film acid-free, not completely plasticizer-free.

Ø 30 mm 2x

Format: 76 x 38 mm (open), 38 x 38 mm (closed)
€ 4019 (Pack of 100)

Ø 40 mm 2x

Format: 100 x 50 mm (open), 50 x 50 mm (closed)
€ 2054 (Pack of 100)

Ø 60 mm 2x

Format: 130 x 65 mm (open), 65 x 65 mm (closed)
€ 4027 (Pack of 100)

Pocket coin album for 48 coins
With 8 coin pages and coin strip inserts made of softener-free hard-PVC-foil, for 6 coins of Ø 36 mm each.
Unpadded cover in different colours.
Suited for 48 coins of Ø 36 mm.
Format: 150 x 100 mm

€ 2070-9* yellow
€ 2070-6* orange
€ 2070-8* red
€ 2070-13* purple
€ 2070-2* light blue
€ 2070-4* lime

Made in EU



NERA S

A stylish storage for sets of 4 or 5 coins. Choose between 4 square compartments for coins or capsules up to Ø 52 mm or 5 square compartments for coins or capsules up to Ø 40 mm. The coin inserts display silver as well as gold coins nicely, thanks to a black, velour-like surface.

Format: 243 x 77 x 38 mm



Ø 40 mm 5x
S 2362-5



Ø 52 mm 4x
S 2362-4

NERA XM

Our NERA Case XM is the perfect solution for storing 12 or 15 coins. Choose between 12 square compartments for coins or coin capsules up to Ø 52 mm or 15 square compartments for coins or capsules up to Ø 40 mm. The coin inserts with a black, velour-like surface, display silver as well as gold coins.

Format: 243 x 187 x 38 mm



Ø 40 mm 15x
S 2363-15

Ø 52 mm 12x
S 2363-12



SOLID WOOD CASE CARUS

Solid wood case in a perfect, dark finish. The surface is smooth and shows the natural grain of the wood. The natural grain of the wood on the outside of the lid as well as the inner side enhances each case giving it an individual character. The appearance of each coin case is enhanced by the stable LINDNER-latch. The coin inserts are covered in high-quality black velour.

CARUS XM

Format: 250 x 190 x 30 mm

Made in Germany



Ø 52 mm 12x
S 2489-12



Ø 40 mm 15x
S 2489-15

CARUS S

Format: 247 x 76 x 30 mm

Made in Germany



Ø 40 mm 5x
S 2490-5



Ø 52 mm 4x
S 2490-4

NERA XS

The smallest version of this series is designed to display that special coin. Whether you are looking for a suitable spot for your favourite collectible or for elegant packaging for a coin gift: our NERA XS offers a variety of purposes. The black velour-like coin insert is a perfect complement to silver or gold coins.

Format: 98 x 88 x 42 mm

Comes with one capsule which features adjustable distance rings. The red rings can be adjusted to the size of the coin. For coin sizes Ø 16-51 mm.

Ø 16-51 mm
S 2360



Suited for coins up to Ø 60 mm.

Ø 60 mm
S 2361



With patented "push in"-insert in which you can place any coin up to Ø 70 mm.

Ø 70 mm
S 2366



COIN CASE FOR ONE SET OF 2 EURO GERMAN COMMEMORATIVE COINS

A black synthetic case with silver inscriptions on the lid and round inserts for keeping and displaying an entire set of 2 Euro German commemorative coins. (All five mint letters).

S 2090



For more products of the NERA series, see page 24-27.

DIGITAL SOLAR-CALIPER

High-quality, digital measuring device made of a carbon fibre compound, with versatile functions and an LCD-display. Can be set to zero position at any time, allowing for differential measuring. Includes feature for measuring depth and internal diameters. Can switch from metric to imperial system. Batteries included.

The carbon fibre compound material guarantees precise and gentle measuring of coins and other objects.

Measuring is possible at any given time, thanks to two energy sources. When the brightness exceeds 200 LUX, the solar cell provides the display with power. When brightness is less than 200 LUX, a 3 Volt Battery supplies the energy.

Technical data:

Measuring scope: 0-150 mm, 6"
 Precision: +/- 0,2 mm, +/-0,01"
 Measuring units: 0,1 mm, 0,01"
€ 8044



COIN GLOVES

Give your coins extra special care. Use these high-quality gloves when handling your most precious coins! Made of 100% cotton. With wristband, in natural colour. One size fits all!

€ 8042 (Pair)



COIN GLOVES WITH GRIP

A smooth cotton glove with a good fitting. Excellent grip because of vinyl-nobs on the inside. Velcro seam for better durability. For work that requires sensitivity. The vinyl-nobs on the inside guarantee a safe and easy handling of the coins. Size 11.

€ 8045 (Pair)



STAINLESS STEEL COIN TONG WITH COATED ENDS

Quality tongs made of stainless steel. The tongs are grained by hand and polished. Due to the matte surface the tongs are dazzle free. The tongs can be sterilised, disinfected and washed.

Length: 115 mm
 Material coating: soft-PVC
€ 2015



Made in Germany

COIN TONG

It is very important to handle your coins carefully to maintain their quality and protect them from dirt. Never touch coins with your fingers; moisture and skin oils can lead to interaction with the metals. To avoid damage of any kind, it is of utmost importance to handle coins only with a quality coin tong. The tips are covered with a protective coating, which guarantees safe handling of your entire coin collection. They are an essential tool.

Length: 120 mm
 Material coating: soft-PVC
€ 2014



Made in Germany

COIN SCALES

Multi-use cover can be used as weighing tray and covers the scale platform. (Size 68 x 50 mm). Without batteries.

Format: 115 x 60 x 20 mm

0,1g
1000g
 Min./Max. **€ 8047**

0,01g
500g
 Min./Max. **€ 8046**



ULTRASONIC CLEANER

For a gentle and hygienic cleaning of coins, watches, jewellery, glasses, CDs, razor heads, silverware, dentures and much more through ultrasound waves. This Ultrasonic cleaner produces small pressure shafts. These pressure waves create millions of tiny air bubbles. The surface is thoroughly cleaned by rupture of the bubbles. By this process, even the dirt in the corners and recesses is removed and absorbed by the liquid.

€ 8090

- Gently cleaning with water or cleaning liquid
- Stainless steel container
- Fine mesh inlay basket of plastic with watch and CD/DVD holder
- Large viewing window in lid
- Capacity: 750 ml
- LCD-Display
- 5 adjustable time intervals
- Power cable with Euro plug

For optimal results we highly suggest the use of our coin cleaner (8015).

Format: 209 x 195 x 128 mm



CLEANER



Made in EU

Coin cleaner on bicarbonate basis (Powder)
Especially suitable for gold, silver, copper, nickel, brass and iron.
Suited for: all coins
Scope of Delivery: 250 g
☛ 8135



Made in Germany

Coin cleaner
First cleaning, then dipping.
Suited for: all coins
Scope of Delivery: 250 ml
☛ 8015



Made in Germany

Cleaning Dip for Silver coins
Suited for: Silver coins
Scope of Delivery: 375 ml
☛ 8092



Made in Germany

Cleaning Dip for Gold coins
Suited for: Gold coins
Scope of Delivery: 375 ml
☛ 8091



☛ 8091, 8092:
Statements

Danger
H318 Causes serious eye damage.
H315 Causes skin irritation.

Caution
H319 Causes serious eye irritation.



Made in Germany

Cleaning Dip for Gold coins
This solution cleans, deoxidises and maintains your coins with brightener and tarnish protection.
Suited for: Gold coins
Scope of Delivery: 250 ml
☛ 8096



Made in Germany

Cleaning Dip for Copper-nickel coins
This solution cleans, deoxidises and maintains your coins with brightener and tarnish protection.
Suited for: Copper-nickel coins
Scope of Delivery: 250 ml
☛ 8098



Made in Germany

Cleaning Dip for Copper and Brass coins
This solution cleans, deoxidises and maintains your coins with brightener and tarnish protection.
Suited for: Copper and Brass coins
Scope of Delivery: 250 ml
☛ 8099



Made in Germany

Cleaning Dip for Bi-metal coins
This solution cleans, deoxidises and maintains your coins with brightener and tarnish protection.
Suited for: Bi-metal coins e.g. 2 €
Scope of Delivery: 250 ml
☛ 8097



Made in Germany

Cleaning Dip for Silver coins
This solution cleans, deoxidises and maintains your coins with brightener and tarnish protection.
Suited for: Silver coins
Scope of Delivery: 250 ml
☛ 8095

Keep all cleaning products out of the reach of children! Safety data sheets can be downloaded from www.lindner-original.de/en.

KARAT-ALBUM FOR PRESSED PENNIES

Padded karat-ring binder made of synthetic material in "Pressed Penny"-Design with 2 karat-pages and white interleaving pages.

Scope of Delivery: Ring binder and 2 karat-coin pages K3W.

Material Ring binder: Padded karat-ring binder made of synthetic material in "Pressed Penny"-Design.

Format Ring binder: 210 x 230 x 35 mm

Mechanism: 4-ring, 45/65/45 mm

Capacity: approx. 10 coin pages

Other ways to collect Pressed Pennies:

Pocket Album for coins see page 47.
HARTBERGER® Coin holders see page 14-15.

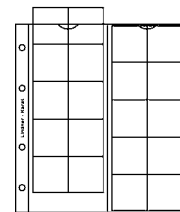
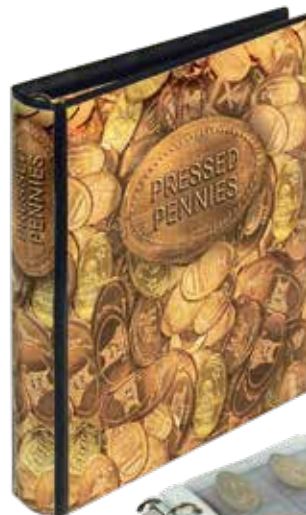

Coin pages available separately per pack of 5 (Order no. K3W).

○ K3W



Made in Germany



KARAT-ALBUM FOR 0-EURO SOUVENIR NOTES WITH 10 FOIL PAGES

Padded karat-ring binder made of synthetic material in "Euro Souvenir"-Design with 10 crystal clear, divided foil pages.

Scope of Delivery: ring binder, 10 crystal clear, divided foil pages (K02)

Material Ring binder: Padded karat-ring binder made of synthetic material in "Euro Souvenir"-Design.

Format Ring binder: 210 x 230 x 35 mm

Mechanism: 4-ring, 45/65/45 mm

Capacity: approx. 50 foil pages.

Foil pages available separately per 10 pages (Order no. K02).



Made in Germany

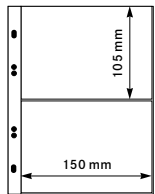

Additional pages:
karat-foil pages with
2 pockets,
pack of 10.

○ K02

Protective sleeves for 0-Euro Souvenir notes

Material: Crystal clear, acid and chemical softener free synthetic-foil, pack of 50.

☛ 893LP



PUBLICA M ALBUM FOR 0-EURO SOUVENIR NOTES WITH 10 FOIL PAGES

Padded ring binder PUBLICA M in "Euro Souvenir"-Design, equipped with 10 crystal clear Multi collect- foil pages for 6 items on each page.

Scope of Delivery: Ring binder, 10 crystal clear foil pages for 6 items on each page (MU3103)

Material Ring binder: Synthetic-foil, padded

Format Ring binder: 245 x 270 x 60 mm

Mechanism: 4-ring, 45/65/45 mm

Capacity: min. 50 foil pages.

Foil pages available separately in pack of 10 (Order-No. MU3103).

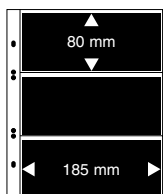

Additional pages:
Multi collect-Banknote pages
three pockets with black
inserts, pack of 10.

● MU3103

Made in Germany



Made in Germany

Other ring binders, for the banknote pages with 18-ring hole punch, can be found on page 72-74.

BANKNOTE ALBUM REGULAR

For collectors who want the perfect storing for their precious banknotes. The popular LINDNER ring binder 1104 comes with 20 softener-free, crystal clear, hard-PVC-pages and 20 black or white interleaving pages. Slipcases are also available in matching colours.

Scope of Delivery:

- 10 crystal clear pocket pages with 2 pockets 240 x 140 mm each.
- 10 crystal clear pocket pages with 3 pockets 240 x 90 mm each.
- 20 cardboard interleaving pages.

Format Ring binder: 305 x 317 x 50 mm

Mechanism: 18-ring

Interleaving pages white	Interleaving pages black	Interleaving pages white	Interleaving pages black
🛒 2810 - G	🛒 2815 - G	🛒 2810-814 - G	🛒 2815-814 - G
🛒 2810 - S	🛒 2815 - S	🛒 2810-814 - S	🛒 2815-814 - S
🛒 2810 - B	🛒 2815 - B	🛒 2810-814 - B	🛒 2815-814 - B
🛒 2810 - H	🛒 2815 - H	🛒 2810-814 - H	🛒 2815-814 - H
🛒 2810 - W	🛒 2815 - W	🛒 2810-814 - W	🛒 2815-814 - W

Crystal clear pocket pages	crystal clear, incl. white interleaving page		crystal clear, incl. black interleaving page	
1 pocket, 240 x 290 mm	🛒 833	🛒 833P	🛒 853	🛒 853P
2 pockets, 240 x 140 mm	🛒 830	🛒 830P	🛒 850	🛒 850P
3 pockets, 240 x 90 mm	🛒 831	🛒 831P	🛒 851	🛒 851P
4 pockets, 240 x 65 mm	🛒 832	🛒 832P	🛒 852	🛒 852P

BANKNOTE ALBUM SRS

Sturdy ring binder with black cover made of padded synthetic-foil. The grained surface in leather-effect gives this ring binder its individual character. The standard mechanism allows an universal use. Includes 2 black cover sheets.

Scope of Delivery:

- 10 crystal clear pocket pages with 2 pockets 240 x 140 mm each.
- 10 crystal clear pocket pages with 3 pockets 240 x 90 mm each.
- 20 white cardboard interleaving pages.

Format Ring binder: 305 x 317 x 50 mm

Mechanism: 4-ring, 80/80/80 mm (also suitable for 18-ring)

🛒 SRSBN	🛒 SRSBN-814

Crystal clear pocket pages	crystal clear, incl. white interleaving page		crystal clear, incl. black interleaving page	
1 pocket, 240 x 290 mm	🛒 833	🛒 833P	🛒 853	🛒 853P
2 pockets, 240 x 140 mm	🛒 830	🛒 830P	🛒 850	🛒 850P
3 pockets, 240 x 90 mm	🛒 831	🛒 831P	🛒 851	🛒 851P
4 pockets, 240 x 65 mm	🛒 832	🛒 832P	🛒 852	🛒 852P



PROTECTIVE SLEEVES FOR BANKNOTES
see page 57.

More uses for the SRS ring binders can be found on page 74.

BANKNOTE ALBUM

Padded LINDNER ring binder in banknote-design with each 5 crystal clear pocket pages with 2 and 3 pockets and interleaving pages. Choose between album with slipcase and album without slipcase.

Scope of Delivery:

- 5 crystal clear pocket pages with 2 pockets 240 x 140 mm each.
- 5 crystal clear pocket pages with 3 pockets 240 x 90 mm each.
- 10 cardboard interleaving pages.

Format Ring binder: 305 x 317 x 50 mm

Mechanism: 18-ring

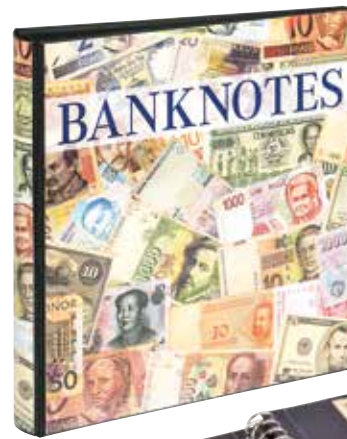

Made in Germany



Crystal clear pocket pages	crystal clear, incl. white interleaving page		crystal clear, incl. black interleaving page	
	1x	10x	1x	10x
1 pocket, 240 x 290 mm	833	833P	853	853P
2 pockets, 240 x 140 mm	830	830P	850	850P
3 pockets, 240 x 90 mm	831	831P	851	851P
4 pockets, 240 x 65 mm	832	832P	852	852P

Other ring binders, for the banknote pages with 18-ring hole punch, can be found on page 72-74.

UNIPLATE SYSTEM FOR BANKNOTES

Two different ring binders are available for banknotes. With 3-ring mechanism.

1 UNIPLATE Ring binder "Standard"

Standard ring binder, made of a blue vinyl material with a smooth, unpadded surface.

Available with or without a matching slipcase.

2 UNIPLATE Ring binder "Luxus"

Deluxe ring binder in winered, made of an attractive, padded leatherette material. Available with or without a matching slipcase.

Format Ring binder: 270 x 295 x 65 mm

Mechanism: 3-ring, 110/110 mm

UNIPLATE PAGES FOR BANKNOTES

Material: Acid and softener free hard-PVC-foil.

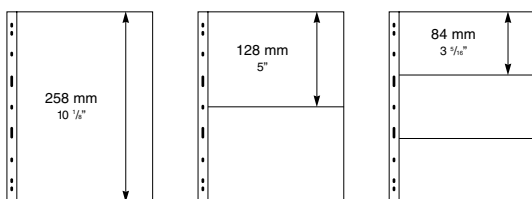

- 071
- 091
- 072
- 092
- 073
- 093

- black (double-sided) Pack of 5
- crystal clear Pack of 5



Made in Germany

1712	1710	1711
1702	1700	1701

Interleaving pages

Black cardboard interleaving pages for crystal clear stockpages, pack of 5. 1786

Details as well as other possibilities for using our versatile UNIPLATE-system are found on page 82.

PUBLICA M BANKNOTE/POSTCARD ALBUM

Padded PUBLICA M ring binder with 20 Multi collect-banknote pages with 2 pockets each. With slipcase made of laminated cardboard. Due to the removable black foil inserts, the pockets can be used as double-sided pages, or you can view both sides of the note single-sided.

Scope of Delivery:

20 Multi collect-banknote pages with 2 pockets 185 x 120 mm each (MU1404).

Format Ring binder: 250 x 280 x 75 mm incl. slipcase

Mechanism: 4-ring Universal, 45/65/45 mm

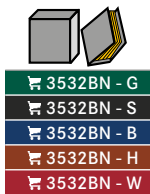
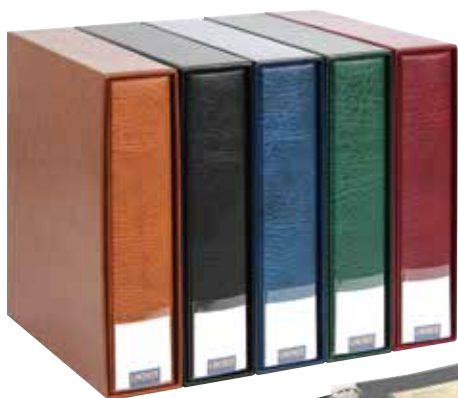

Made in Germany

Details as well as other possibilities for using our versatile Multi collect-system are found on page 40-43.

MULTI COLLECT-SYSTEM FOR BANKNOTES

Ring binder made of padded synthetic-foil. The grained surface in leather-effect gives the ring binder its individual character. The typical 4-ring mechanism of the Multi collect-ring binder guarantees a simple handling and the ring binder impresses with its large capacity. The generous spine window offers space for content listing.

Format Ring binder: 245 x 270 x 80 mm

Mechanism: 4-ring, 40/80/40 mm



Made in Germany

1302 - G	1300 - G	1301 - G
1302 - S	1300 - S	1301 - S
1302 - B	1300 - B	1301 - B
1302 - H	1300 - H	1301 - H
1302 - W	1300 - W	1301 - W

Details as well as other possibilities for using our versatile Multi collect-system are found on page 40-43.

MULTI COLLECT-PAGES FOR BANKNOTES

Material: Acid and softener-free hard-PVC foil.

- black, double-sided
Pack of 10
- crystal clear
Pack of 10
- crystal clear, with black inserts
Pack of 10

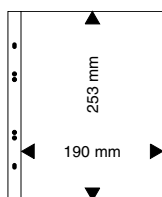

● MU1311
○ MU1321

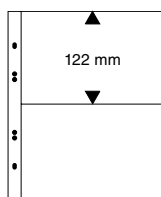

● MU1312
○ MU1322

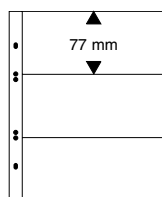

● MU1313
○ MU1323

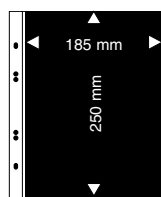

● MU1405

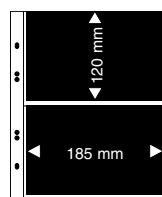

● MU1404

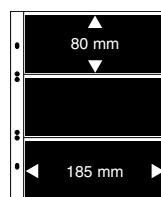

● MU3103

Interleaving pages

Interleaves are recommended for interleaving purposes, pack of 20. **MU1385**

Black paper interleaving pages, pack of 10. **MU1386**

PUBLICA LS FOR BANKNOTES

The high-quality ring binder from the PUBLICA series offers a uniform, classical and timeless design. The sturdy construction and the quality materials selected for this ring binder guarantee many years of use. The padded leatherette cover has a standard mechanism and is also available with a matching slipcase. A large, clear index window on the spine allows you to insert a description for easy identification of the contents. Suitable for our A4 stockpages and other pages with DIN A4 format with standard hole punch.

Format Ring binder: 290 x 315 x 60 mm

Mechanism: 4-ring, 80/80/80 mm

Matching pages for banknotes in black or crystal clear:



2 strips 150 x 220 mm



3 strips 97 x 220 mm

● 4102

○ 8812

(Pack of 10)

● 4103

○ 8813

(Pack of 10)



Made
in
Germany

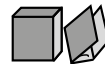

3533 - G	3503 - G	3504 - G
3533 - S	3503 - S	3504 - S
3533 - B	3503 - B	3504 - B
3533 - H	3503 - H	3504 - H
3533 - W	3503 - W	3504 - W

Details as well as other possibilities for using our versatile PUBLICA-system are found on page 86-88.

BANKNOTE ALBUM PUBLICA M

Padded ring binder PUBLICA M in banknote-design with 20 Multi collect-banknote pages with 2 and 3 pockets.

With black slipcase made of laminated cardboard. Due to the removable black foil inserts, the pockets can be used as double-sided pages, or you can view both sides of the note single-sided.

Scope of Delivery:

10 Multi collect-banknote pages with 2 pockets 185 x 120 mm each (MU1404)

10 Multi collect-banknote pages with 3 pockets 185 x 80 mm each (MU3103)

Format Ring binder: 245 x 270 x 60 mm

Mechanism: 4-ring Universal, 45/65/45 mm

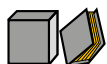

3537E



3537



3537R

Details as well as other possibilities for using our versatile Multi collect-system are found on page 40-43.



Made
in
Germany



FIRMO UNIVERSAL ALBUMS

The FIRMO Universal albums made of a high-quality leatherette cover offers plenty of space for banknotes, FDC's, letters, photos, postcards etc. The crystal clear synthetic sleeves with black paper inserts are made of PVC-foil that can be used from both sides. The pages open at the inner side so that the documents are protected from dirt and falling out. The albums are carefully produced and are characterised by their plain elegance.

FIRMO XL

With 56 crystal clear synthetic sleeves that can be used from both sides. The black paper inserts can be used as a divider.

For 224 items up to the size of 245 x 132 mm.

Format: 285 x 305 x 75 mm

🛒 812XL



- 812XL-R
- 812XL-B
- 812XL-S

FIRMO L

With 54 crystal clear synthetic sleeves that can be used from both sides. The black paper inserts can be used as a divider.

For 108 items up to the size of 245 x 132 mm.

Format: 285 x 155 x 75 mm

🛒 812L



- 812L-R
- 812L-B
- 812L-S

FIRMO

With 54 crystal clear synthetic sleeves that can be used from both sides. The black paper inserts can be used as a divider.

For 108 items up to the size of 190 x 130 mm.

Format: 230 x 155 x 75 mm

🛒 812



- 812-R
- 812-B
- 812-S



POCKET ALBUM FOR BANKNOTES

Handy pocket album with padded dark blue synthetic cover. With 20 crystal clear sleeves. Ideal for e.g. banknotes, postcards or other receipts or documents.



Format: 230 x 155 x approx. 20 mm
Suited for: Banknotes, documents up to 210 x 125 mm.

🛒 S818

Format: 195 x 110 x approx. 20 mm
Suited for: Banknotes, documents up to 175 x 85 mm.

🛒 S817

● S818

● S817

PROTECTIVE SLEEVES FOR BANKNOTES

All protective sleeves are made from a crystal clear, acid and chemical softener-free synthetic-foil. Film thickness: 0.1 mm. All measurements are internal measurements in mm. The red line identifies the open side.

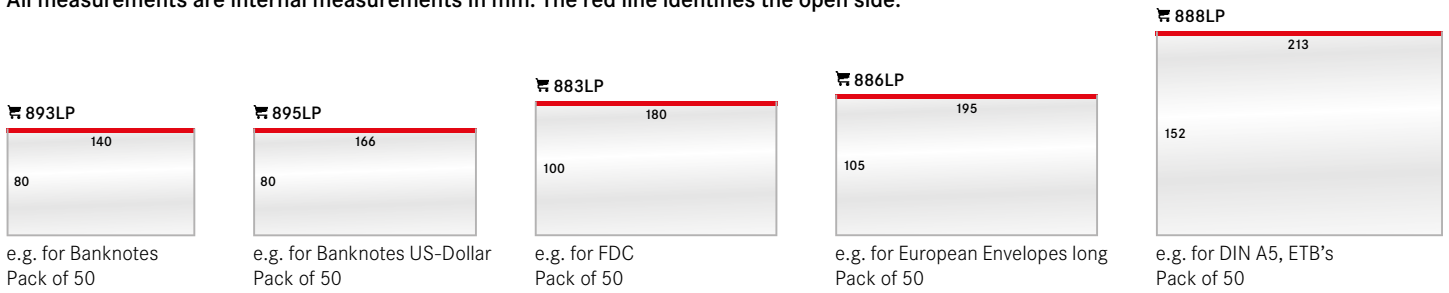

FREESTYLE PROTECTIVE SLEEVES FOR BANKNOTES

FOIL SHEETS OF OUR RENOWNED PROTECTIVE COVERS WITH SELF-ADHESIVE STRIP ON THE LEFT SIDE

Using the self-adhesive strip, the covers can be mounted individually on each album page. In this way, the protective covers can be integrated into any conventional collection system.

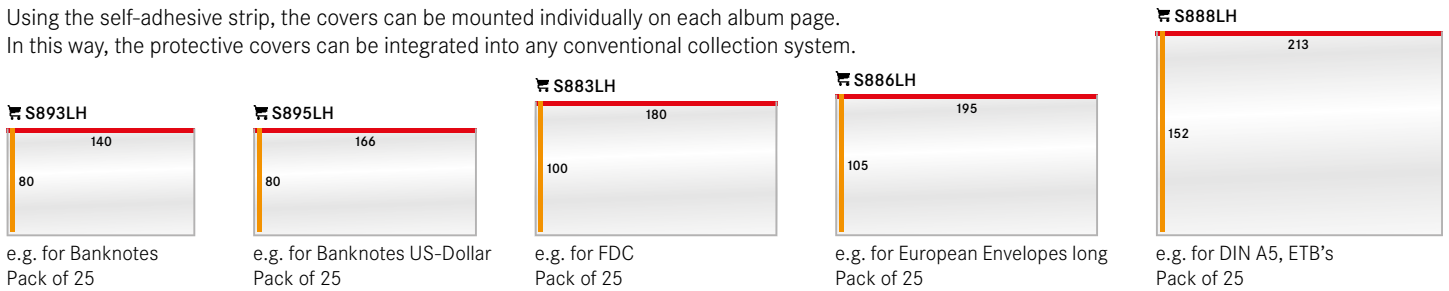

A detailed description of the LINDNER protective sleeves or LINDNER T-freestyle protective sleeves with all possibilities can be found on page 90/91.

FOLDING SLEEVES WITH FLAP FOR BANKNOTES

Simple and gentle insertion and protection of the collectibles. Simply open and insert slip, close and secure with folding flap. Best protection made of hard-PVC-foil.

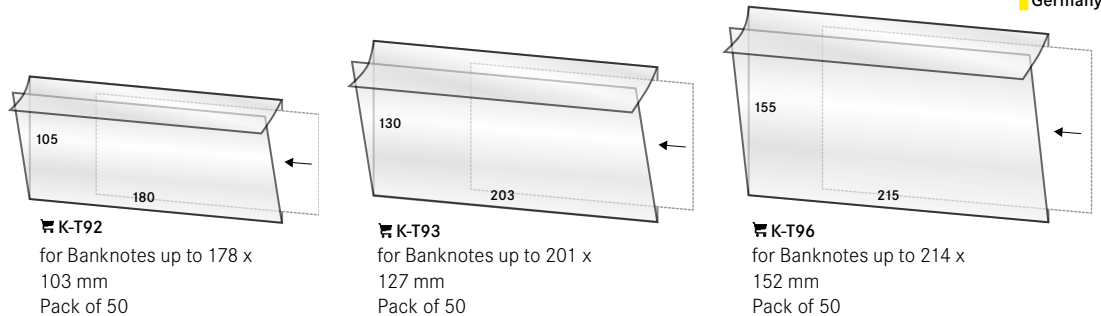

Identification according to Regulation (EC) No. 1272/2008 Statements:

ERNI A (8070)

Caution

- H315 Causes skin irritation.
- H319 Causes serious eye irritation.
- H411 Toxic to aquatic life with long lasting effects.



ERNI B (8071)

Caution

- H290 Can be corrosive to metals.
- H315 Causes skin irritation.
- H319 Causes serious eye irritation.
- H317 Can cause allergic reactions to your skin.
- H351 Suspected of causing cancer.
- H373 May cause damage to organs through prolonged or repeated exposure.



ERNI CARE PRODUCTS

It's all about retaining the value and perfection!
Content: 200 ml.

To remove mold stains in three simple steps. ERNI A disinfects, with ERNI B you wash out.

ERNI A and ERNI B must be used together.

Please follow the instructions for proper cleaning.

8070 ERNI A, 200 ml

8071 ERNI B, 200 ml



before cleaning

after cleaning

LINDNER T-SYSTEM

Each page of the LINDNER T-system is made of a PERMAPHIL®-cardboard page and a hard-PVC-foil sheet which is fixed on the left side of the page. The foil sheets are softer and acid free. You can choose between many variations of insertion strips in different heights and widths. The stamps are inserted into the foil strips and are thereby protected on both sides. Due to the quality of the foil, you always have a “crystal clear” view of your stamps. The gentle clamp effect of the foil seam, which is produced by a special foil welding process, ensures that the stamps stay at their intended place. The foil sheet is glued on the cardboard sheet by a special adhesive process at the left side. This allows a simple leafing. Because of this, you can easily have a look on the front and the rear of the stamps without taking them out of the foil sheet. This is a typical character of the LINDNER T-system. The high-quality of material and production ensure an easy remove of the stamps, without the fear of damage. All pages of the LINDNER T-system have 18-ring hole punch, which gives them a sturdy hold in all LINDNER ring binders with 18-ring mechanism. The LINDNER ring binders can be found on page 72-74.

LINDNER T-ILLUSTRATED COUNTRY ALBUMS

Illustrated stamp pages were developed for those collectors who like to collect certain or several countries, with the entire stamp issue years. The stamps are depicted on the card pages and provide a fixed place for the stamps. This helps to portray each issue. Our employees in the LINDNER philatelic department collect and process issued stamps of over 150 countries for you. For those who collect internationally, there is no way around using our illustrated pages. They ensure that our collector owns the complete collection. Stamps will illustrate events of a country, they inform you about parts of the world, organisations and communities, allow insights into cultures and tell of highlights in history, politics and science. Stamps allow you to experience international events up close. The illustrated pages provide anticipation for stamps which have not yet been issued, and tell you which stamps still need to be found. Place the stamp in the provided place in the foil sheets. You can lay the stamp directly over the stamp illustration on the page. The stamp now lies entirely protected by the sheet foil. Each year, supplements are issued for the previous year, ensuring that your collection is always up to date.

LINDNER DOUBLE T-ILLUSTRATED PAGES

The LINDNER double T-illustrated stamp pages were developed for collectors, who wish to collect the new stamps as well as used stamps and do not want to purchase two sets of illustrated pages. The stamps are printed on both back and front side of these card pages. The foil sheets are glued on both front and back of the page, so that you can keep the new stamps on the front side and the used stamps on the reverse.

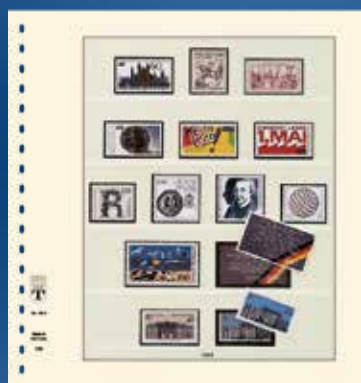



The beginnings of the album productions in Schömberg around 1950.

LINDNER T-BLANK AND LINDNER DT-BLANK-SYSTEM FOR THE TOPICAL OR THE CREATIVE INDIVIDUAL COLLECTOR

This system offers countless possibilities for the individualists and creative collectors who like to design their own stamp collections. Unlike the illustrated pages, these pages are not printed but remain blank. The LINDNER T-Blank-system has over 80 different page variations with different foil sheet strips for an individual set up of stamp collecting.

An advantage in the LINDNER T-Blank-system is that the stamps can always be removed or the page rearranged. The page will not be damaged and can be used to design a new collection. For collectors that like to add text or pictures, we offer the LINDNER write-up pages with many possibilities.

The write-up pages can be designed by hand or on the computer and are then placed between the card page and foil sheet, turning each page into an individual eye-catcher. The size of the write-up pages corresponds to the different kinds of T-Blank-pages.

LINDNER PAPER QUALITY

All LINDNER systems use the exclusive PERMAPHIL®-cardboard, which protects a stamp collection from the aging process and harmful environmental influences for decades. Impressive facts about our PERMAPHIL®-cardboard:

- a pH value of more than 7.5 which makes it acid free,
- age resistant due to a low calcium carbonate content,
- free of optical brighteners,
- free of acid-forming components,
- bleached without chlorine,
- firm album quality,
- paper weight: 200 g / sqm.



T-BLANK-PAGES

This system offers countless possibilities for the individualists and creative collectors who like to design their own stamp collections. Unlike the illustrated pages, these pages are not printed but remain blank. The LINDNER T-Blank-system has over 80 different page variations with different foil sheet strips for an individual set up of stamp collecting.

An advantage in the LINDNER T-Blank-system is that the stamps can always be removed or the page rearranged. The page will not be damaged and can be used to design a new collection. For collectors that like to add text or pictures, we offer the LINDNER write-up pages with many possibilities.

The write-up pages can be designed by hand or on the computer and are then placed between the card page and foil sheet, turning each page into an individual eye-catcher. The size of the write-up pages corresponds to the different kinds of T-Blank-pages.

All LINDNER systems use the exclusive PERMAPHIL®-cardboard, which protects a stamp collection from the aging process and harmful environmental influences. Keep your stamp collection in pristine condition for decades.

Format: 272 x 296 mm
Paper weight: 200 g / sqm



INSERTS FOR WRITE-UPS
see page 64.

ADVANTAGE OFFER: COMPANION SET REGULAR (1124) INCL. 2 PACKAGES T-BLANK PAGES OR DT-BLANK PAGES OF YOUR CHOICE

Scope of Delivery:
Companion set REGULAR (Order-Nr. 1124),
incl. 2x pack of 10 T-Blank Pages of your choice
or 2x pack of 5 dt-Blank Pages of your choice.



- 1124TB - G
- 1124TB - S
- 1124TB - B
- 1124TB - H
- 1124TB - W

1 POCKET

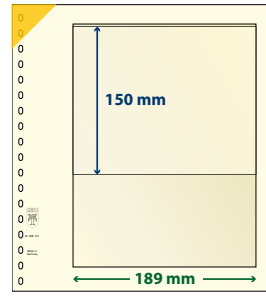

802101
802101P (Pack of 10)
Matching inserts for write-ups: A

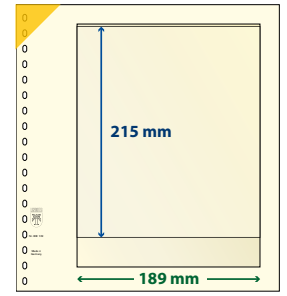

802102
802102P (Pack of 10)
Matching inserts for write-ups: A

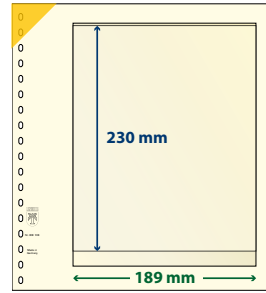

802108
802108P (Pack of 10)
Matching inserts for write-ups: A

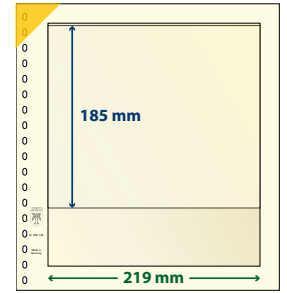

802109
802109P (Pack of 10)
Matching inserts for write-ups: B

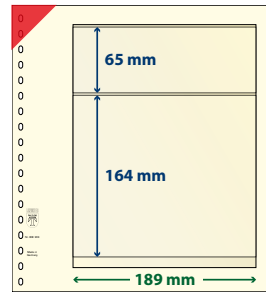

802203
802203P (Pack of 10)
Matching inserts for write-ups: A

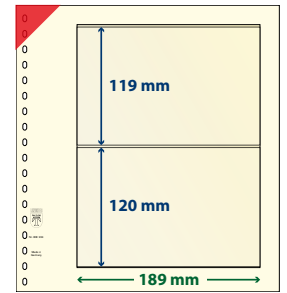

802204
802204P (Pack of 10)
Matching inserts for write-ups: A

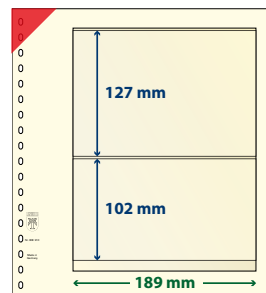

802210
802210P (Pack of 10)
Matching inserts for write-ups: A

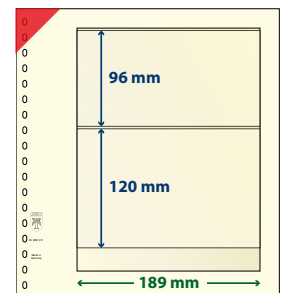

802211
802211P (Pack of 10)
Matching inserts for write-ups: A

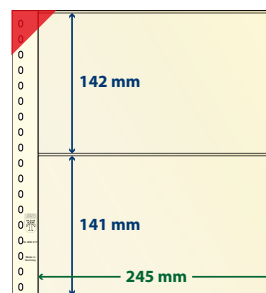

802217
802217P (Pack of 10)
Matching inserts for write-ups: E

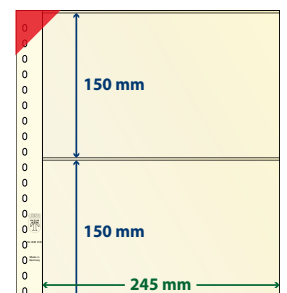

802218
802218P (Pack of 10)
Matching inserts for write-ups: E

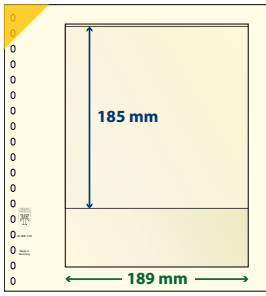

802103
802103P (Pack of 10)
Matching inserts for write-ups: A

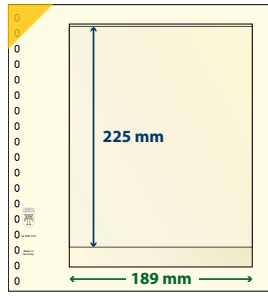

802104
802104P (Pack of 10)
Matching inserts for write-ups: A

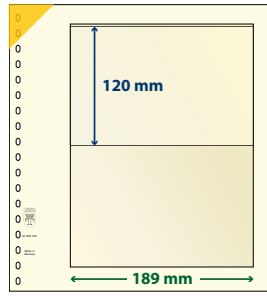

802105
802105P (Pack of 10)
Matching inserts for write-ups: A

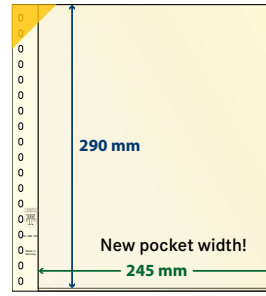

802106
802106P (Pack of 10)
Matching inserts for write-ups: E

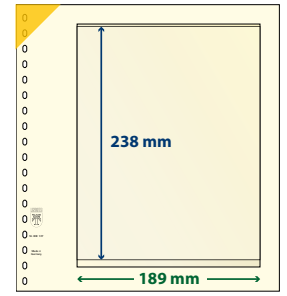

802107
802107P (Pack of 10)
Matching inserts for write-ups: A

2 POCKETS

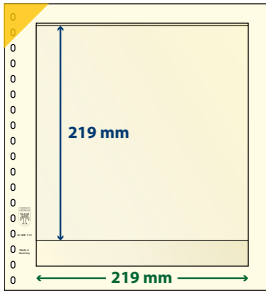

802110
802110P (Pack of 10)
Matching inserts for write-ups: B

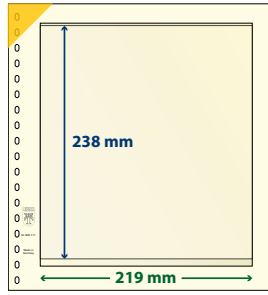

802111
802111P (Pack of 10)
Matching inserts for write-ups: B

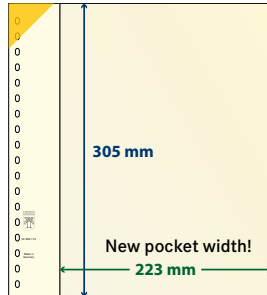

802112
802112P (Pack of 10)
Format: 272 x 305 mm

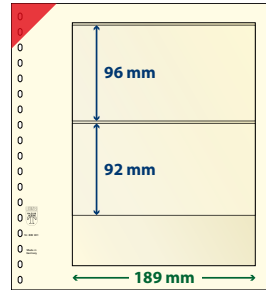

802201
802201P (Pack of 10)
Matching inserts for write-ups: A

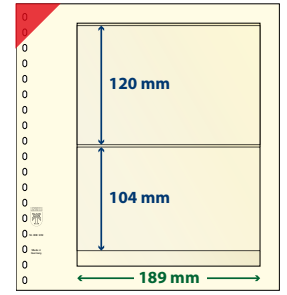

802202
802202P (Pack of 10)
Matching inserts for write-ups: A

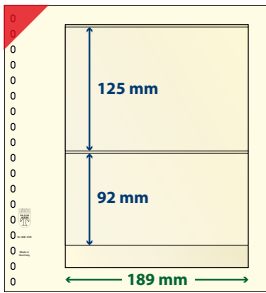

802205
802205P (Pack of 10)
Matching inserts for write-ups: A

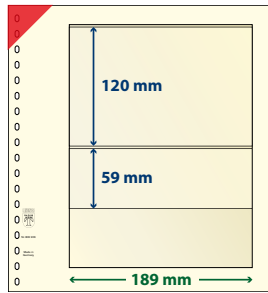

802206
802206P (Pack of 10)
Matching inserts for write-ups: A

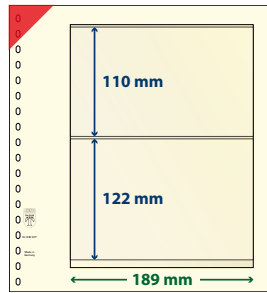

802207
802207P (Pack of 10)
Matching inserts for write-ups: A

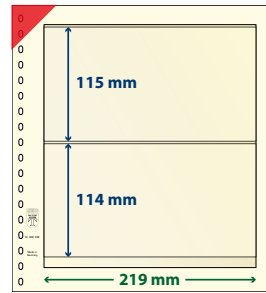

802208
802208P (Pack of 10)
Matching inserts for write-ups: B

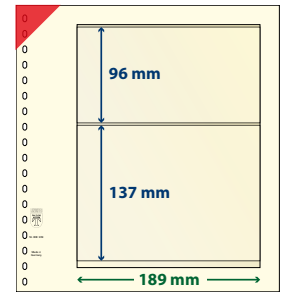

802209
802209P (Pack of 10)
Matching inserts for write-ups: A

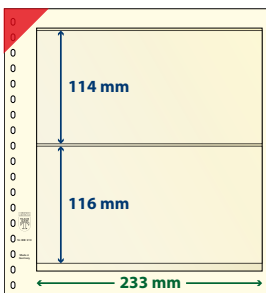

802212
802212P (Pack of 10)
Matching inserts for write-ups: C

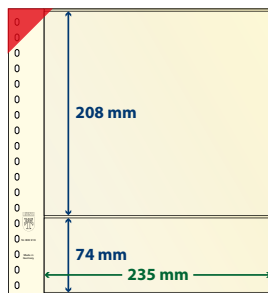

802213
802213P (Pack of 10)
Matching inserts for write-ups: D

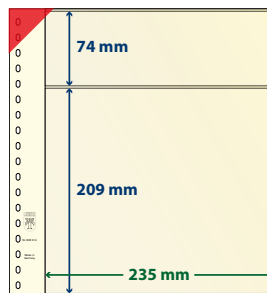

802214
802214P (Pack of 10)
Matching inserts for write-ups: D

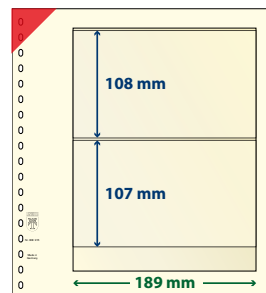

802215
802215P (Pack of 10)
Matching inserts for write-ups: A

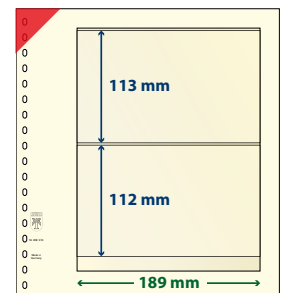

802216
802216P (Pack of 10)
Matching inserts for write-ups: A

3 POCKETS

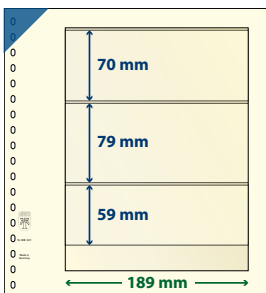

802301
802301P (Pack of 10)
Matching inserts for write-ups: A

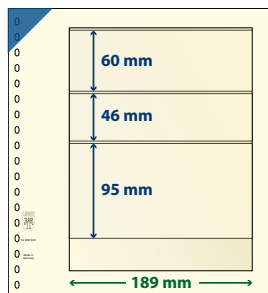

802302
802302P (Pack of 10)
Matching inserts for write-ups: A

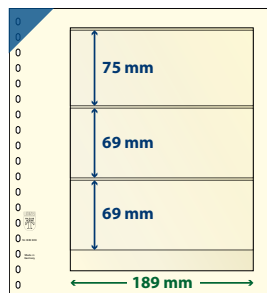

802303
802303P (Pack of 10)
Matching inserts for write-ups: A

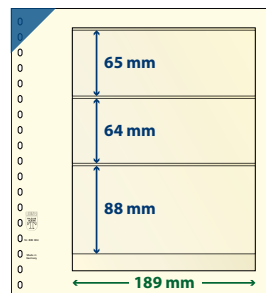

802304
802304P (Pack of 10)
Matching inserts for write-ups: A

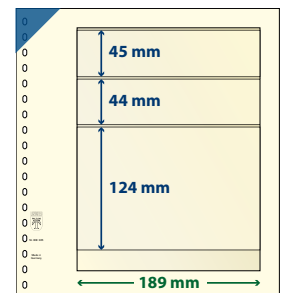

802305
802305P (Pack of 10)
Matching inserts for write-ups: A

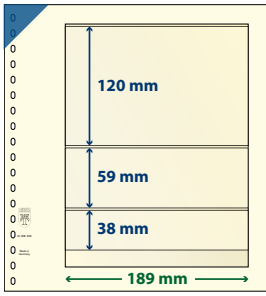

802306
802306P (Pack of 10)
Matching inserts for write-ups: A

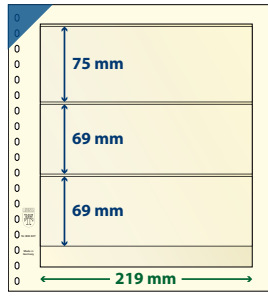

802307
802307P (Pack of 10)
Matching inserts for write-ups: B

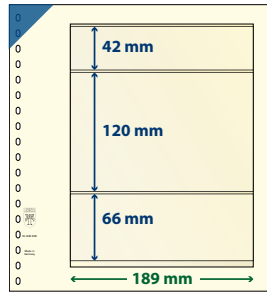

802308
802308P (Pack of 10)
Matching inserts for write-ups: A

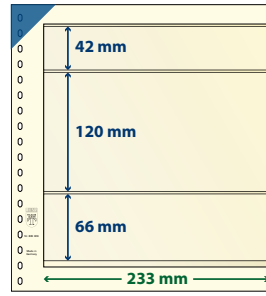

802309
802309P (Pack of 10)
Matching inserts for write-ups: C

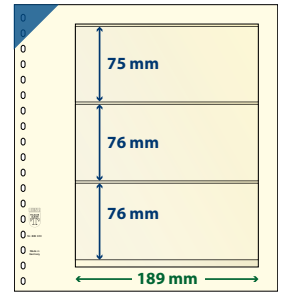

802310
802310P (Pack of 10)
Matching inserts for write-ups: A

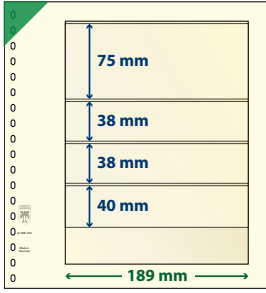

802403
802403P (Pack of 10)
Matching inserts for write-ups: A

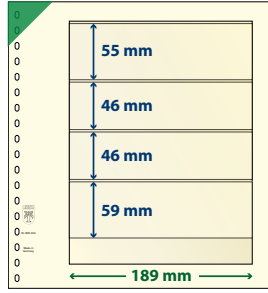

802404
802404P (Pack of 10)
Matching inserts for write-ups: A

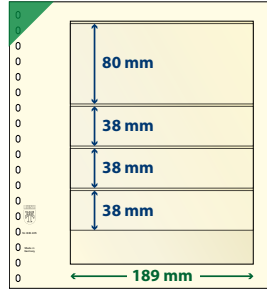

802405
802405P (Pack of 10)
Matching inserts for write-ups: A

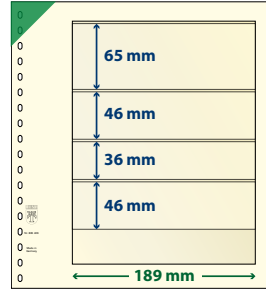

802406
802406P (Pack of 10)
Matching inserts for write-ups: A

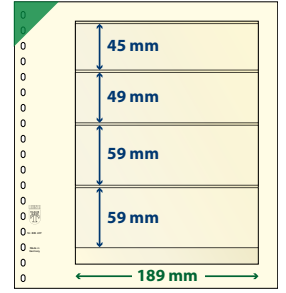

802407
802407P (Pack of 10)
Matching inserts for write-ups: A

5 POCKETS

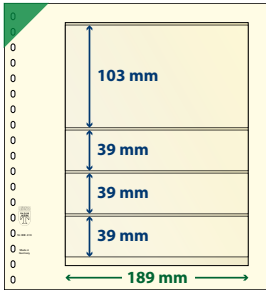

802413
802413P (Pack of 10)
Matching inserts for write-ups: A

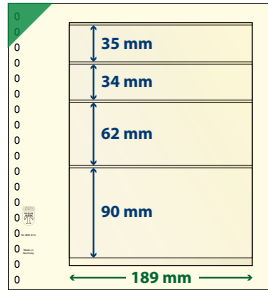

802414
802414P (Pack of 10)
Matching inserts for write-ups: A

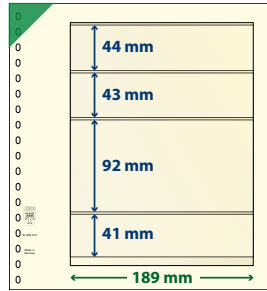

802415
802415P (Pack of 10)
Matching inserts for write-ups: A

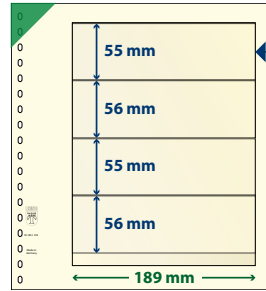

802420 short side open
802420P (Pack of 10)
Open at the short side
Matching inserts for write-ups: A

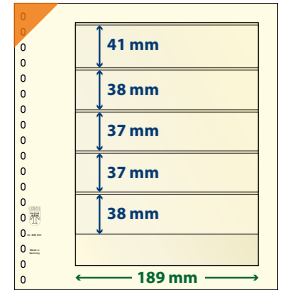

802501
802501P (Pack of 10)
Matching inserts for write-ups: A

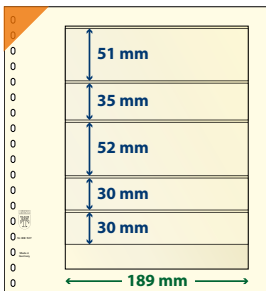

802507
802507P (Pack of 10)
Matching inserts for write-ups: A

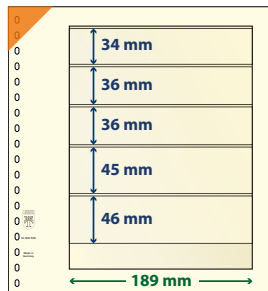

802508
802508P (Pack of 10)
Matching inserts for write-ups: A

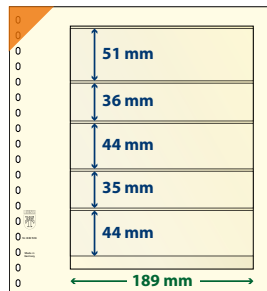

802509
802509P (Pack of 10)
Matching inserts for write-ups: A

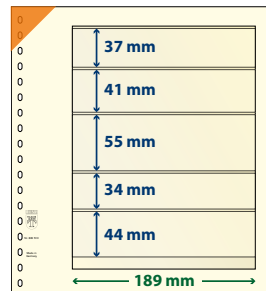

802510
802510P (Pack of 10)
Matching inserts for write-ups: A

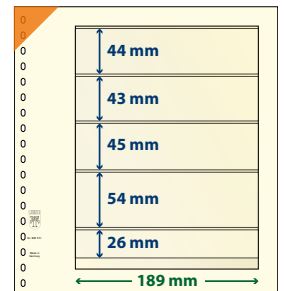

802511
802511P (Pack of 10)
Matching inserts for write-ups: A

7 POCKETS

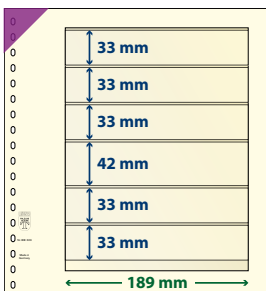

802603
802603P (Pack of 10)
Matching inserts for write-ups: A

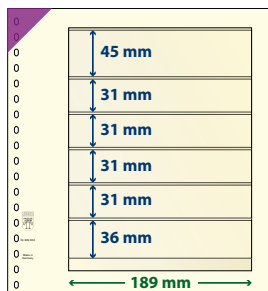

802604
802604P (Pack of 10)
Matching inserts for write-ups: A

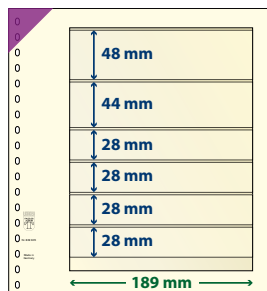

802605
802605P (Pack of 10)
Matching inserts for write-ups: A

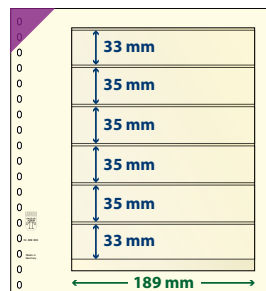

802606
802606P (Pack of 10)
Matching inserts for write-ups: A

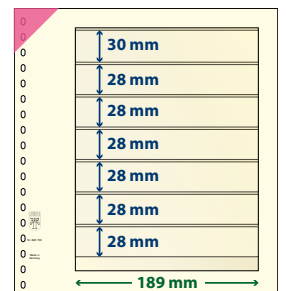

802700
802700P (Pack of 10)
Matching inserts for write-ups: A

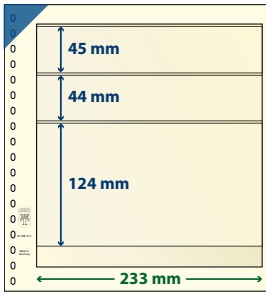

802311
802311P (Pack of 10)
Matching inserts for write-ups: C

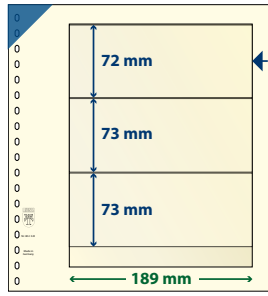

802320
802320P (Pack of 10)
Open at the short side
Matching inserts for write-ups: A

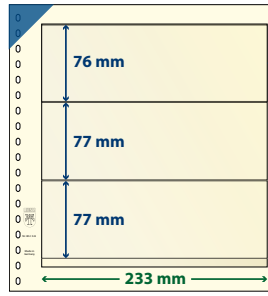

802322
802322P (Pack of 10)
Open at the short side
Matching inserts for write-ups: C

4 POCKETS

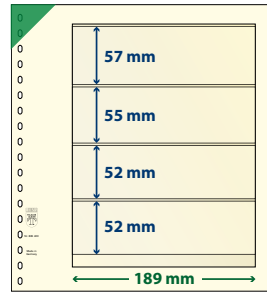

802400
802400P (Pack of 10)
Matching inserts for write-ups: A

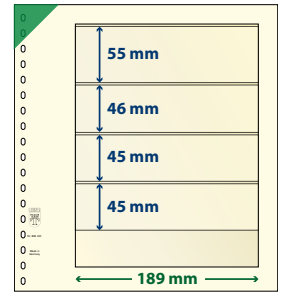

802401
802401P (Pack of 10)
Matching inserts for write-ups: A

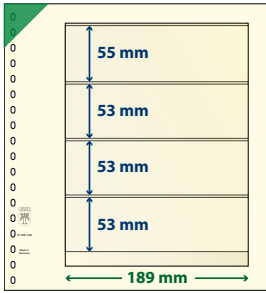

802408
802408P (Pack of 10)
Matching inserts for write-ups: A

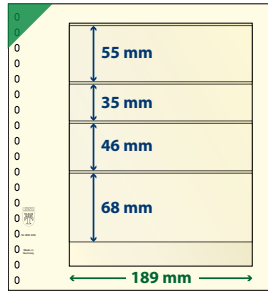

802409
802409P (Pack of 10)
Matching inserts for write-ups: A

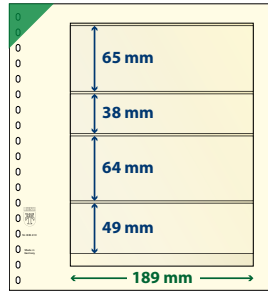

802410
802410P (Pack of 10)
Matching inserts for write-ups: A

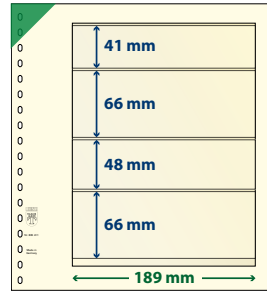

802411
802411P (Pack of 10)
Matching inserts for write-ups: A

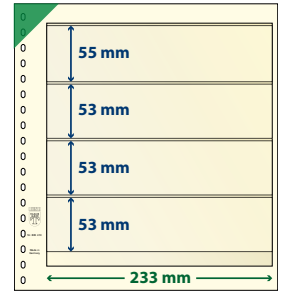

802412
802412P (Pack of 10)
Matching inserts for write-ups: C

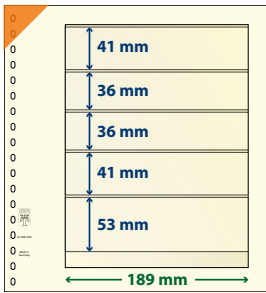

802502
802502P (Pack of 10)
Matching inserts for write-ups: A

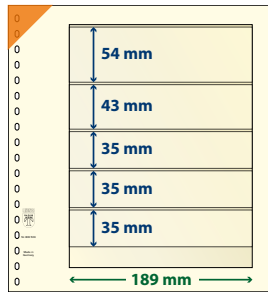

802503
802503P (Pack of 10)
Matching inserts for write-ups: A

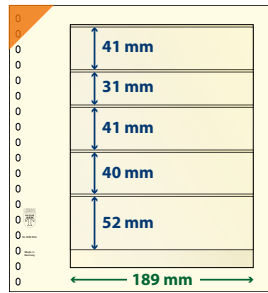

802504
802504P (Pack of 10)
Matching inserts for write-ups: A

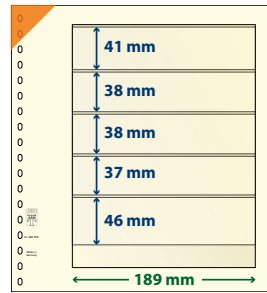

802505
802505P (Pack of 10)
Matching inserts for write-ups: A

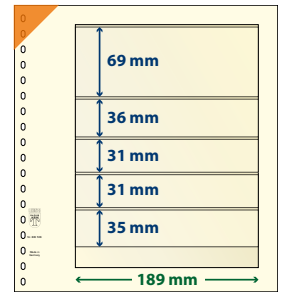

802506
802506P (Pack of 10)
Matching inserts for write-ups: A

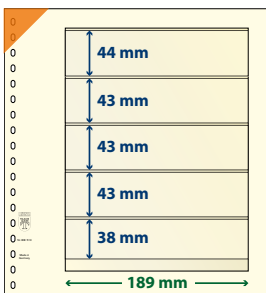

802512
802512P (Pack of 10)
Matching inserts for write-ups: A

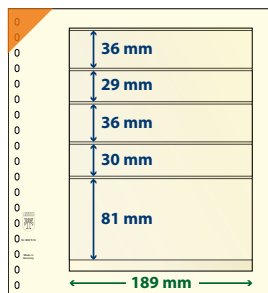

802513
802513P (Pack of 10)
Matching inserts for write-ups: A

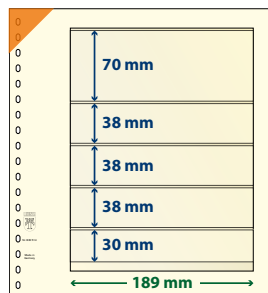

802514
802514P (Pack of 10)
Matching inserts for write-ups: A

6 POCKETS

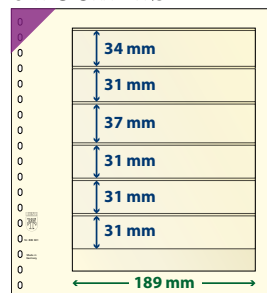

802601
802601P (Pack of 10)
Matching inserts for write-ups: A

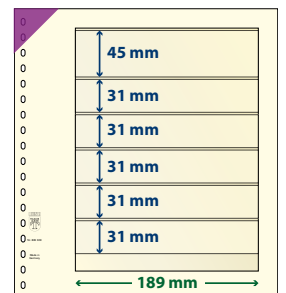

802602
802602P (Pack of 10)
Matching inserts for write-ups: A

8 POCKETS

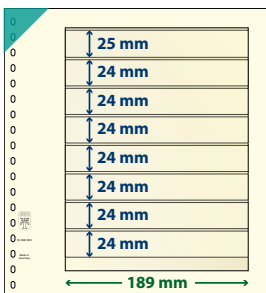

802800
802800P (Pack of 10)
Matching inserts for write-ups: A

PAGES WITH VERTICAL POCKETS

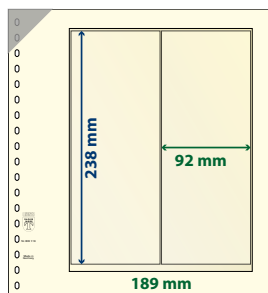

802119
802119P (Pack of 10)
Pages with vertical pockets
Matching inserts for write-ups: A

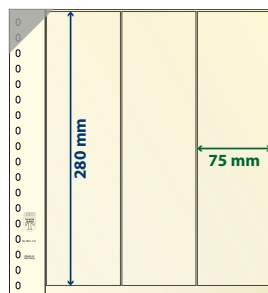

802121
802121P (Pack of 10)
Pages with vertical pockets
Matching inserts for write-ups: D

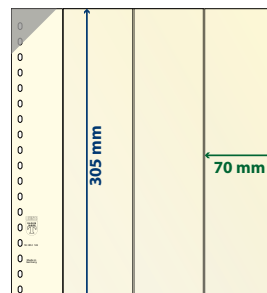

802122
802122P (Pack of 10)
Pages with vertical pockets
Format: 272 x 305 mm

dT-BLANK-PAGES

THE MOST POPULAR T-BLANK-PAGES ARE ALSO AVAILABLE IN THE DT-VERSION WITH FOIL SHEETS ON BOTH SIDES

1 POCKET

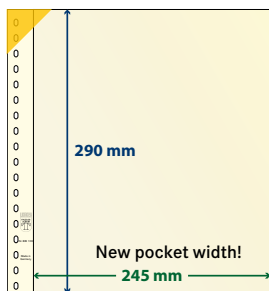

dt802106P (Pack of 5)
Matching inserts for write-ups: E

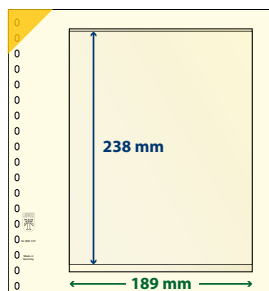

dt802107P (Pack of 5)
Matching inserts for write-ups: A

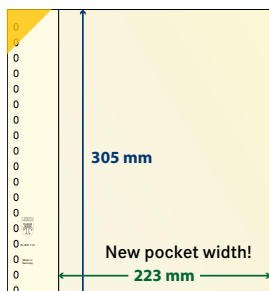

dt802112P (Pack of 5)
Format: 272 x 305 mm

2 POCKETS

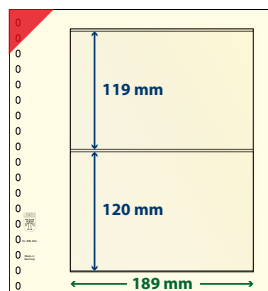

dt802204P (Pack of 5)
Matching inserts for write-ups: A

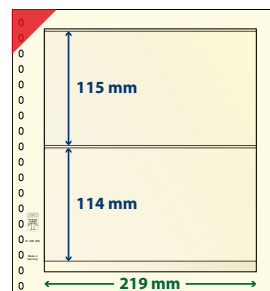

dt802208P (Pack of 5)
Matching inserts for write-ups: B

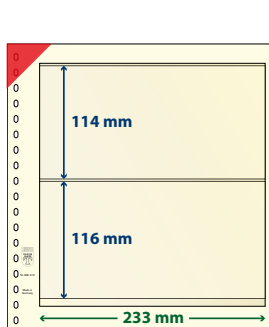

dt802212P (Pack of 5)
Matching inserts for write-ups: C

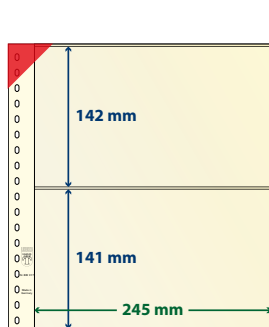

dt802217P (Pack of 5)
Matching inserts for Write-Ups: E

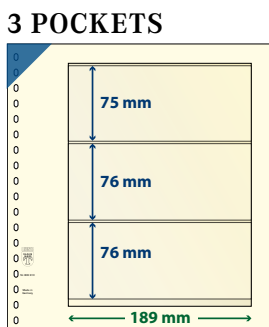

dt802310P (Pack of 5)
Matching inserts for write-ups: A

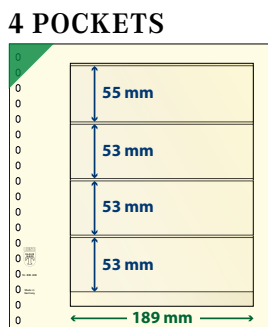

dt802408P (Pack of 5)
Matching inserts for write-ups: A

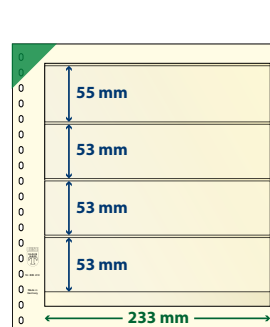

dt802412P (Pack of 5)
Matching inserts for write-ups: C

5 POCKETS

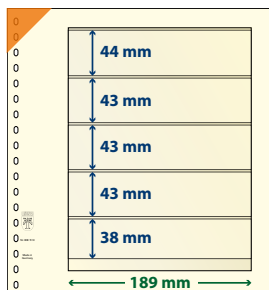

dt802512P (Pack of 5)
Matching inserts for write-ups: A

6 POCKETS

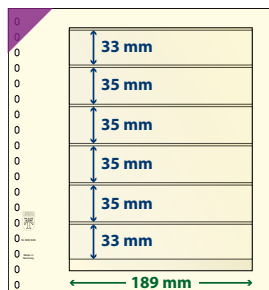

dt802606P (Pack of 5)
Matching inserts for write-ups: A

7 POCKETS

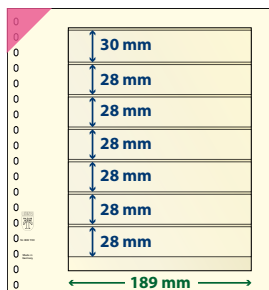

dt802700P (Pack of 5)
Matching inserts for write-ups: A

8 POCKETS

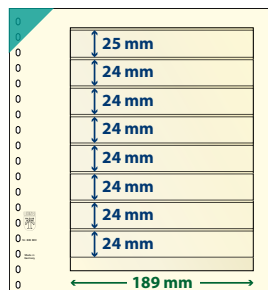

dt802800P (Pack of 5)
Matching inserts for write-ups: A

Format: 272 x 296 mm
Paper weight: 200 g / sqm



EXHIBITION PROTECTORS

Made from a crystal clear, acid and softener free hard-PVC-foil.

18-ring perforation



Fits all LINDNER pages in the size of 272 x 296 mm (802-802do) Opens on the perforated side.	880	880P
Fits all A4 size pages 210 x 297 mm (805-805o) Opens on the perforated side.	8804	8804P
Fits all A4 size pages 210 x 297 mm (805-805o)	---	8805-18-1

4-ring perforation (UNIVERSAL)



Fits all A4 size pages 210 x 297 mm (805-805o)	8805-1	8805*
--	--------	-------

* same as 8805-1 but made from a thinner softener-free PP-foil

INSERTS FOR WRITE-UPS

The "write-up" sheet is placed between the hard-PVC-foil sleeve and the album page. They are available in black or white. The black sheets are designed for collectors who prefer to have a black background behind the stamps. The contrast enhances perforations, colour, and the beauty of the featured stamps. The white sheets can be used to add any text, pictures or illustrations to the sheet and can be exchanged at any time.

A	B	C	D	E
Format: 249 x 183 mm	Format: 249 x 215 mm	Format: 249 x 228 mm	Format: 296 x 231 mm	Format: 296 x 242 mm
○ 802001 ● 802002	○ 802013 ● 802014	○ 802015 ● 802016	○ 802017 ● 802018	○ 802011 ● 802012
Pack of 100	Pack of 100	Pack of 100	Pack of 100	Pack of 100



BLANK-PAGES

LINDNER Blank-pages are offered in many different styles and colours. Collectors can create a customized collection since it is so easy to label, print, colour, glue or cut the durable cardboard pages. The pages are made of our special PERMAPHIL®-cardboard: It is acid-free, neutrally bonded and

natural and absolutely age-resistant. The Blank-pages in A4 Format can be used with PC, Laser, ink jet printer, as well as, old-fashioned typewriters to create descriptions and write-ups.

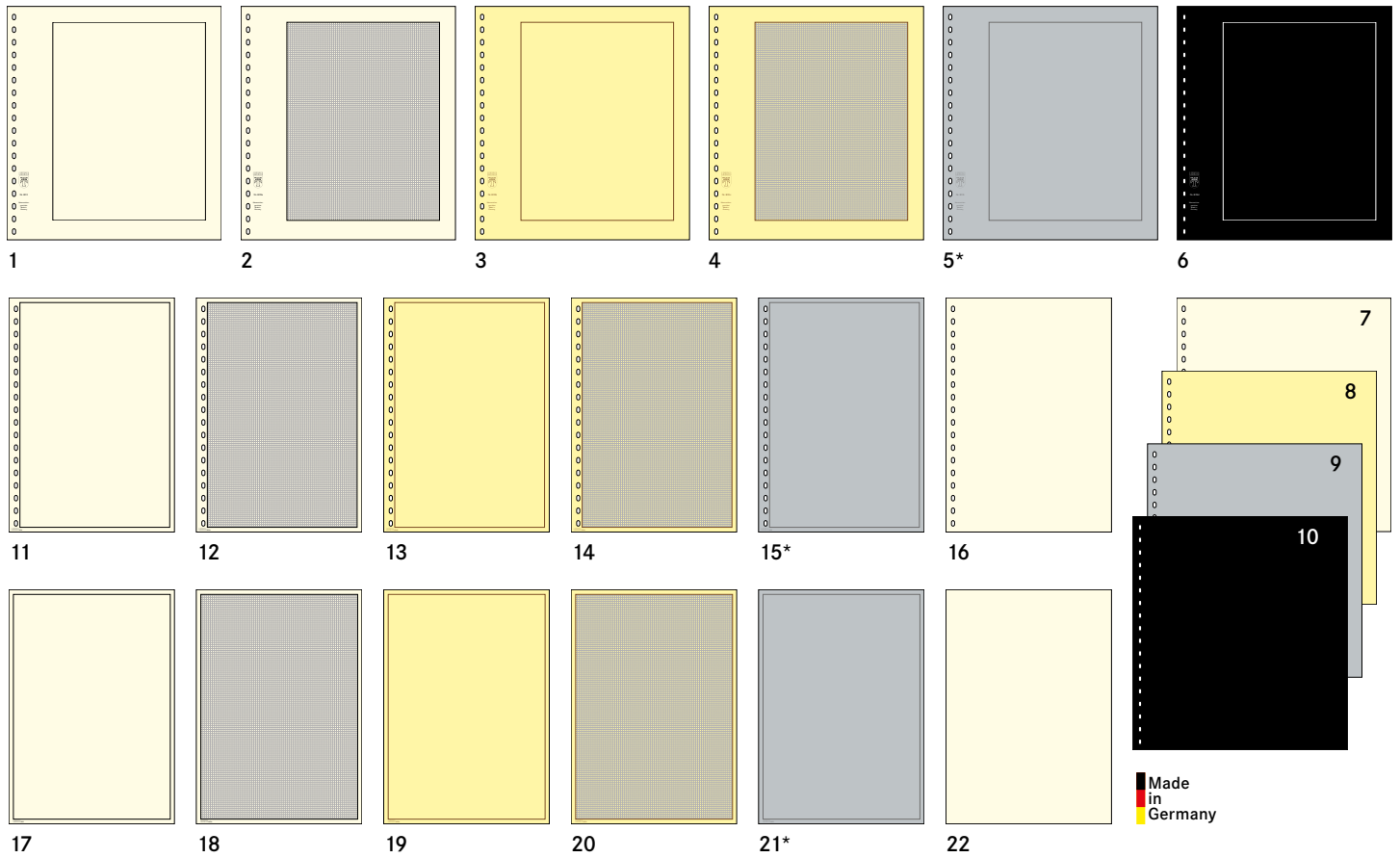

With 18-ring perforation Size: 272 x 296 mm; matching crystal clear pocket page 880.			Paper strength
1	802	White page, Black border (193 x 251 mm) (Pack of 10)	200 g/qm
2	802a	White page, Black border (193 x 251 mm), Grey border (Pack of 10)	
3	802b	Yellow page, Brown border (193 x 251 mm) (Pack of 10)	160 g/qm
4	802c	Yellow page, Brown border (193 x 251 mm), Quadrille ruling (Pack of 10)	
5	802i*	Silver-grey page, Grey border (193 x 251 mm) (Pack of 10)	170 g/qm
6	802d	Black page, White border (193 x 251 mm) (Pack of 10)	200 g/qm
7	802o	White page, plain (Pack of 10)	200 g/qm
8	802bo	Yellow page, plain (Pack of 10)	160 g/qm
9	802io*	Silver-grey page, plain (Pack of 10)	170 g/qm
10	802do	Black page, plain (Pack of 10)	200 g/qm
With 18-ring perforation Size: DIN A4 (210 x 297 mm); matching crystal clear pocket page 8804.			
11	804	White page, Black border (190 x 285 mm) (Pack of 10)	170 g/qm
12	804a	White page, Grey border, Black border (190 x 285 mm) (Pack of 10)	
13	804b	Yellow page, Brown border (190 x 285 mm) (Pack of 10)	160 g/qm
14	804c	Yellow page, Brown border (190 x 285 mm), Quadrille ruling (Pack of 10)	
15	804i*	Silver-grey page, Grey border (190 x 285 mm) (Pack of 10)	170 g/qm
16	804o	White page, plain (Pack of 10)	170 g/qm
Without holes Size: DIN A4 210 x 297 mm; matching crystal clear pocket pages 8805-18-1, 8805-1, 8805.			
17	805	White page, Black border (199 x 286 mm) (Pack of 10)	170 g/qm
18	805a	White page, Grey border, Black border (199 x 286 mm) (Pack of 10)	
19	805b	Yellow page, Brown border (199 x 286 mm) (Pack of 10)	160 g/qm
20	805c	Yellow page, Brown border (199 x 286 mm), Quadrille ruling (Pack of 10)	
21	805i*	Silver-grey page, Grey border (199 x 286 mm) (Pack of 10)	170 g/qm
22	805o	White page, plain (Pack of 10)	170 g/qm

Exhibition protectors see page 64. Fitting ring binders are found on page 72-74.

LINDNER T-FREESTYLE FOIL SHEETS

Design your own individual collection with all advantages of our LINDNER T-system.

Our popular LINDNER T-Blank page foil sheets, with self-adhesive strip on the left side!

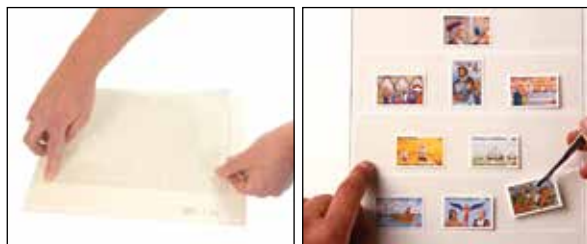
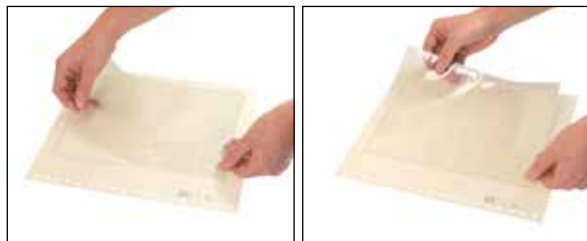
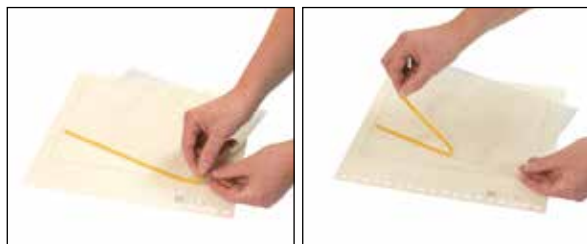
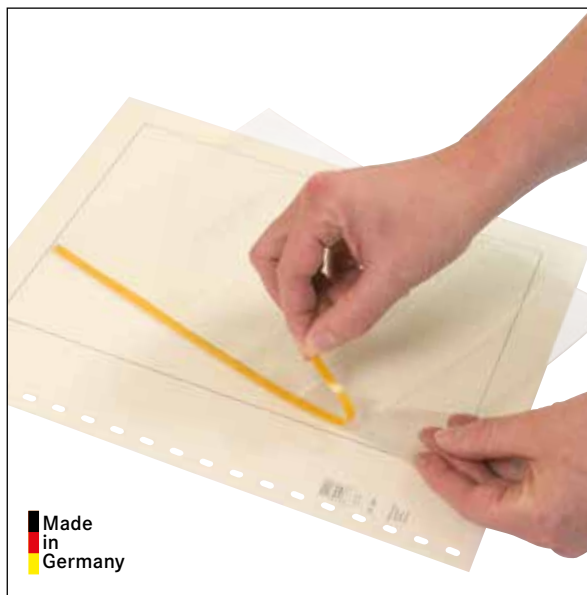

1. Determine the exact position for the foil on your sheet.
2. Remove the protective strip from the adhesive on the back of the foil.
3. Place the foil at the previously determined position and press it firmly to the album page.

Format: 250 x 193 mm

Maximum width of content: 189 mm

The practical freestyle-foil sleeves are now also in protective sleeve format available – see page 91.



S802107H
(Pack of 5)

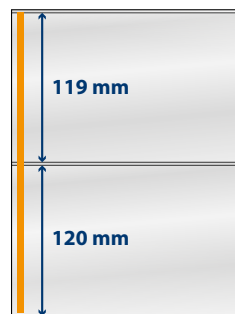

S802204H
(Pack of 5)

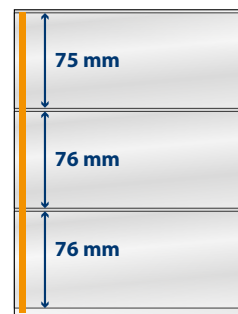

S802310H
(Pack of 5)

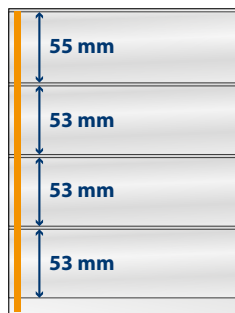

S802408H
(Pack of 5)



S802512H
(Pack of 5)



S802606H
(Pack of 5)



S802700H
(Pack of 5)



S802800H
(Pack of 5)

The LINDNER-T foil sheets are acid- and softener-free.

Made in Germany

Protection on both sides of the stamp. Clear view of the stamp.

Stamps can be viewed by turning the page (they don't have to be removed from the protective sheet).

Secure fixture of the stamps by gentle clamping effect of the foil seams.

LINDNER T-freestyle can be integrated into each available collection-system. This offers the possibility to complete or expand an existing collection, regardless of which type of collection system is being used.

Choose the page format and position.

Layout the pages as you require, then affix the LINDNER T-freestyle foil sheet.

For an even more flexible collection-system, use the LINDNER inserts for write ups. Layout the labeling sheets as you require and then place them between the foil sheet and the album page. This offers the advantage of being able to remove the labeling sheet and re-use the album page.

Inserts for write-ups see page 64 and Blank-pages see page 65.

ACCESSORIES FOR CUSTOM PAGE DESIGN

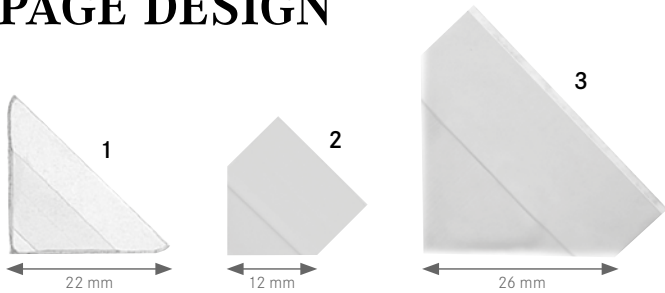

SELF-ADHESIVE CORNER MOUNTS

These self-adhesive corner mounts are the perfect little helpers! Photos, envelopes, postcards and other collectibles can be securely positioned.

1	🛒 802019	Pack of 250
2	🛒 802029	Pack of 600, backing made out of paper.
3	🛒 802039	Pack of 100, transparent, extra large corner mounts to hold large photos, postal stationery and FDC's.

PRE-FOLDED STAMP HINGES

Stamp hinges are ready to use - prefolded with acid free gum.

- 🛒 7040 Pack of 1000
- 🛒 7041 50 packages of 1000



INDICATOR DECALS

For indicating errors or varieties etc. in your collection.

Colour: red. Arrows, self-adhesive.

- 🛒 802020 Pack of 100



ROTARY CUTTER

- Cutting length max. 330 mm (A4+)
- Cutter with stable metal table
Table size (overall dimensions) 440 x 190 mm
- Helpful format lines on the base to align the material to be cut
- The transparent paper clip prevents slipping of the paper. The sturdy guide rail for the cutting head guarantees a clean and straight cut.
- Weight 1.0 kg
- Cuts up to 10 sheets at once.

Format: 440 x 190 x 70 mm

Material: Metal

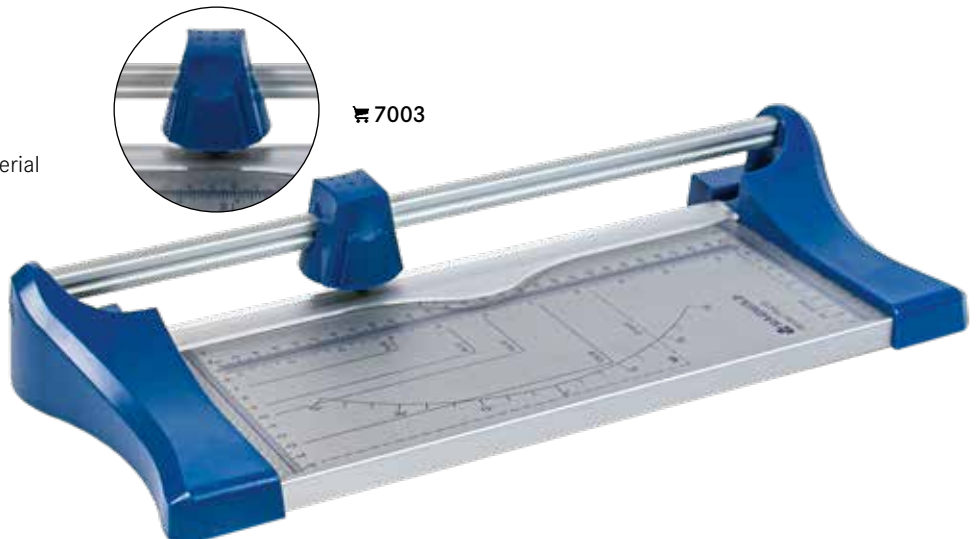

🛒 7003

ADVANTAGE OFFER: COMPANION SET: RING BINDER REGULAR WITH SLIPCASE (1124) INCL. 20 OMNIA- PAGES OF YOUR CHOICE

Scope of Delivery:

Ring binder and slipcase,
20 Omnia-pages (2x packs of 10) of your choice.

Stockpages Omnia see page 70.



- 🛒 1124Omnia - G
- 🛒 1124Omnia - S
- 🛒 1124Omnia - B
- 🛒 1124Omnia - H
- 🛒 1124Omnia - W



Made in Germany

ASSORTMENT OF PROTECTIVE MOUNTS

The thin and extremely stable protective mount is made of softener-free PVC-foil. It consists out of one basic-foil with a gumming and one crystal clear cover-foil. For affixing the mounts you only have to moisten them at the bottom side.

Partial, there are still remainders of products that are no longer listed. We sell these products as long as stock lasts.

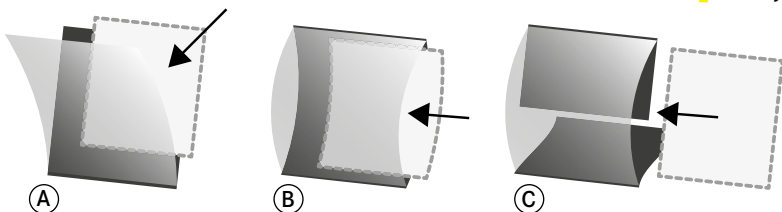

CLAMPING POCKET:

Clamping pocket with a gummed basic-foil for inserting stamps from the top or the side. For stamps with exceptional formats, you can cut the pockets into the needed format.

DOUBLE WELDED SEAM:

Closed at the bottom and the top, with a gummed basic-foil. For inserting the stamps from the side.

KLEMMFIX:

Closed at the bottom and the top, with a horizontal cut in the gummed basic-foil. Guaranteed non-slip hold of the stamps.

STRIPS

Stamp size Width x Height	🛒 black	🛒 crystal clear	Packaging unit
SUPER LONG (SL) STRIPS (265 mm) ® double welded = closed at the bottom and the top			
265 x 80 mm	HA12080	HA22080	10
265 x 85 mm	HA12085	HA22085	10
265 x 90 mm	HA12090	HA22090	10
265 x 95 mm	HA12095	HA22095	10
265 x 100 mm	HA12100	HA22100	10
265 x 105 mm	HA12105	HA22105	8
265 x 110 mm	HA12110	HA22110	8
265 x 115 mm	HA12115	HA22115	8
265 x 120 mm	HA12120	HA22120	8
265 x 125 mm	HA12125	HA22125	8
265 x 130 mm	HA12130	HA22130	7
265 x 135 mm	HA12135	HA22135	7
265 x 140 mm	HA12140	HA22140	7
265 x 145 mm	HA12145	HA22145	7
265 x 150 mm	HA12150	HA22150	7
265 x 155 mm	HA12155	HA22155	6
265 x 160 mm	HA12160	HA22160	6

STRIPS

Stamp size Width x Height	🛒 black	🛒 crystal clear
STRIPS (A) 25 pieces, colour of packing: yellow		
210 x 21 mm	HA1021	HA2021
210 x 24 mm	HA1024	HA2024
210 x 25 mm	HA1025	HA2025
210 x 26 mm	HA1026	HA2026
210 x 27,5 mm	HA1027	HA2027
210 x 29 mm	HA1029	HA2029
210 x 30 mm	HA1030	HA2030
210 x 31 mm	HA1031	HA2031
210 x 32 mm	HA1032	HA2032
210 x 33 mm	HA1033	HA2033
210 x 34 mm	HA1034	HA2034
STRIPS (A) 25 pieces, colour of packing: green		
210 x 35 mm	HA1035	HA2035
210 x 36 mm	HA1036	HA2036
210 x 37 mm	HA1037	HA2037
210 x 39 mm	HA1039	HA2039
210 x 40 mm	HA1040	HA2040
210 x 41 mm	HA1041	HA2041
210 x 43 mm	HA1043	HA2043
210 x 44 mm	HA1044	HA2044
210 x 48 mm	HA1048	HA2048
210 x 49 mm	HA1049	HA2049
210 x 52 mm	HA1052	HA2052
210 x 53 mm	HA1053	HA2053
210 x 55 mm	HA1055	HA2055

Stamp size Width x Height	🛒 black	🛒 crystal clear
STRIPS (B) double welded = closed at the bottom and the top 10 pieces, colour of packing: white		
210 x 58 mm	HA1058	HA2058
210 x 60 mm	HA1060	HA2060
210 x 64 mm	HA1064	HA2064
210 x 66 mm	HA1066	HA2066
210 x 68 mm	HA1068	HA2068
210 x 70 mm	HA1070	HA2070
210 x 72 mm	HA1072	HA2072
210 x 75 mm	HA1075	HA2075
210 x 78 mm	HA1078	HA2078
210 x 82 mm	HA1082	HA2082
210 x 86 mm	HA1086	HA2086

Width x Height	🛒 black	🛒 crystal clear
KLEMMFIX STRIPS FOR COIL STRIPS (C) Klemmfix system = closed at the bottom and the top, with a horizontal cut in the basic-foil		
25 pieces 255 x 22 mm	HA1320	HA2320
20 pieces 385 x 22 mm	HA1321	HA2321
KLEMMFIX STRIPS (C) Klemmfix system = closed at the bottom and the top, with a horizontal cut in the basic-foil 22 pieces, colour of packing: beige		
210 x 21 mm	HA4021	HA3021
210 x 22 mm	HA4022	HA3022
210 x 24 mm	HA4024	HA3024
210 x 25 mm	HA4025	HA3025
210 x 26 mm	HA4026	HA3026
210 x 27 mm	HA4027	HA3027
210 x 29 mm	HA4029	HA3029
210 x 30 mm	HA4030	HA3030
210 x 31 mm	HA4031	HA3031
210 x 32 mm	HA4032	HA3032
210 x 33 mm	HA4033	HA3033
210 x 34 mm	HA4034	HA3034
KLEMMFIX STRIPS (C) Klemmfix system = closed at the bottom and the top, with a horizontal cut in the basic-foil 15 pieces, colour of packing: beige		
210 x 35 mm	HA4035	HA3035
210 x 36 mm	HA4036	HA3036
210 x 39 mm	HA4039	HA3039
210 x 40 mm	HA4040	HA3040
210 x 41 mm	HA4041	HA3041
210 x 42 mm	HA4042	HA3042
210 x 43 mm	HA4043	HA3043
210 x 44 mm	HA4044	HA3044
210 x 45 mm	HA4045	HA3045
210 x 48 mm	HA4048	HA3048
210 x 49 mm	HA4049	HA3049
210 x 52 mm	HA4052	HA3052
210 x 53 mm	HA4053	HA3053
210 x 55 mm	HA4055	HA3055

BLOCK SIZES

Stamp size Width x Height	🛒 black	🛒 crystal clear	Packaging unit
BLOCK SIZES (B) double welded = closed at the bottom and the top			
130 x 85 mm	HA1201	HA2201	10
135 x 143 mm	HA1135143	-----	10
148 x 105 mm (DIN A6)	HA1202	HA2202	10
148 x 210 mm (DIN A5)	HA1206	HA2206	6
160 x 120 mm	HA1203	HA2203	10
210 x 170 mm	HA1204	HA2204	3
245 x 185 mm	HA1245185	-----	6
A4 large blocks, with double weld			
297 x 210 mm (DIN A4)	HA1318	HA2318	5

Width x Height	Stamp size Width x Height	🛒 black	🛒 crystal clear	Packaging unit
KLEMMFIX BLOCK SIZES (C) for mint sheets of 10 pieces Klemmfix system = closed at the bottom and the top, with a horizontal cut in the basic-foil				
115 x 164 mm	46 x 27,5 mm	HA1237	HA2237	8
129 x 90 mm	21,5 x 30,5 mm	HA1239	HA2239	8
138 x 82 mm	23 x 27,5 mm	HA1231	HA2231	13
153 x 68 mm	21,5 x 26 mm	HA1230	HA2230	13
156 x 111 mm	43 x 26 mm	HA1234	HA2234	8
156 x 116 mm	43 x 26 mm	HA1235	HA2235	8
165 x 99 mm	27,5 x 33 mm	HA1232	HA2232	8
196 x 138 mm	33 x 55 mm	HA1236	HA2236	5
198 x 83 mm	33 x 27,5 mm	HA1233	HA2233	8
210 x 105 mm	35 x 35 mm	HA1238	HA2238	6

Stamp size Width x Height	🛒 black	🛒 crystal clear	Packaging unit
KLEMMFIX BLOCK SIZES (C) Klemmfix system = closed at the bottom and the top, with a horizontal cut in the basic-foil			
162 x 115 mm	HA1211	HA2211	10
165 x 95 mm	HA1210	HA2210	10
197 x 197 mm	HA1216	HA2216	4
230 x 162 mm	HA1217	HA2217	4
237 x 154 mm	HA1215	HA2215	4

CUTS

Stamp size Width x Height	🛒 (A) black	🛒 (A) crystal clear	🛒 (C) black
CUTS (A) 50 pieces, colour of packing: blue			
19 x 22 mm	HA61922	HA71922	-----
20 x 24 mm	HA6013	HA7013	HA20024
20 x 26 mm	HA6023	HA7023	HA20026
21 x 24 mm	HA6014	HA7014	-----
21,5 x 26 mm	HA6024	HA7024	-----
21,5 x 30 mm	HA6043	HA7043	-----
22 x 26 mm	HA6021	HA7021	-----
22 x 31 mm	HA62231	HA72231	-----
23 x 26 mm	HA6022	HA7022	-----
23 x 27,5 mm	HA6032	HA7032	-----
24 x 20 mm	HA6004	HA7004	-----
24 x 21 mm	HA6007	HA7007	-----
24 x 29 mm	HA6037	HA7037	-----
24 x 40 mm	HA6056	HA7056	-----
25 x 30 mm	HA6040	HA7040	-----
25 x 36 mm	HA6085	HA7085	-----
26 x 20 mm	HA6005	HA7005	-----
26 x 21,5 mm	HA6010	HA7010	-----
26 x 31 mm	HA6047	HA7047	-----
26 x 36 mm	HA6051	HA7051	-----
26 x 40 mm	HA6057	HA7057	-----
26 x 41 mm	HA6061	HA7061	-----
26 x 43 mm	HA6064	HA7064	-----
27,5 x 33 mm	HA6050	HA7050	-----
28 x 34 mm	HA6049	HA7049	-----
28 x 39 mm	HA6052	HA7052	-----
29 x 24 mm	HA6015	HA7015	-----
29 x 36 mm	HA6058	HA7058	-----
30 x 36 mm	HA6059	HA7059	-----
30 x 39 mm	HA6053	HA7053	-----
31 x 24 mm	HA6016	HA7016	-----
31 x 26 mm	HA6025	HA7025	-----
31 x 32 mm	HA6031	HA7031	-----
33 x 27,5 mm	HA6033	HA7033	-----
34 x 28 mm	HA6036	HA7036	-----
36 x 25 mm	HA6084	HA7084	-----
36 x 26 mm	HA6026	HA7026	-----
36 x 29 mm	HA6038	HA7038	-----
36 x 30 mm	HA6041	HA7041	-----
39 x 23 mm	HA63923	HA73923	-----
39 x 28 mm	HA6035	HA7035	-----
39 x 30 mm	HA6042	HA7042	-----
40 x 24 mm	HA6020	HA7020	-----
40 x 26 mm	HA6027	HA7027	HA40026
41 x 24 mm	HA6017	HA7017	-----
41 x 26 mm	HA6028	HA7028	-----
43 x 26 mm	HA6029	HA7029	-----
44 x 26 mm	HA64426	HA74426	-----
CUTS (A) 50 pieces, colour of packing: red			
30 x 41 mm	HA6113	HA7113	HA30041
32 x 53 mm	-----	-----	HA32053
33 x 39 mm	HA63339	HA73339	-----
33 x 55 mm	HA6124	HA7124	-----
35 x 35 mm	HA6109	HA7109	-----
40 x 33 mm	HA6108	HA7108	-----
41 x 30 mm	HA6101	HA7101	-----
41 x 41 mm	HA6116	HA7116	-----
41 x 53 mm	HA6121	HA7121	HA41053
46 x 27,5 mm	HA6100	HA7100	-----
53 x 32 mm	-----	-----	HA53032
53 x 41 mm	HA6115	HA7115	HA53041
55 x 33 mm	HA6105	HA7105	-----

MOUNTS KILOWARE: 1ST QUALITY

Mounts made of 100 % Polystyrol with black and crystal clear background are well-known to collectors all over the world due to their top quality. For affixing the mounts you only have to moisten them at the bottom side. Available in packs of 200 g, 500 g and 1000 g you also find mounts for blocks. All strips included in the packs have a length of 210 mm and can be cut into the desired width.

Special production from 1000 g.

Mixed strips	🛒 black	🛒 crystal clear
50 g	S10050	W10050
100 g	S10100	W10100
200 g	S10200	W10200
500 g	S10500	W10500
1000 g	S11000	W11000



GUILLOTINE

Guillotine cutting machine

- Cutting length max. 150 mm
- Transparent hold-down device and measuring scales in cm and inches on both sides
- Strong, ground knife with screwed stainless steel cutting surface
- Can be used creatively and is particularly easy to use
- Suitable for paper, foil and thin cardboard

Format: 140 x 195 x 30 mm



Compact guillotine with sturdy solid metal table and non-slip rubber feet for firm standing

- Cutting length max. 320 mm
- Table size (overall dimensions) 420 x 175 mm
- Helpful format lines on the base make aligning the material to be cut easier
- Manual clamping for holding down the material being cut
- Weight 1,66 kg
- Cuts up to 8 sheets at once.

Format: 565 x 190 x 50 mm

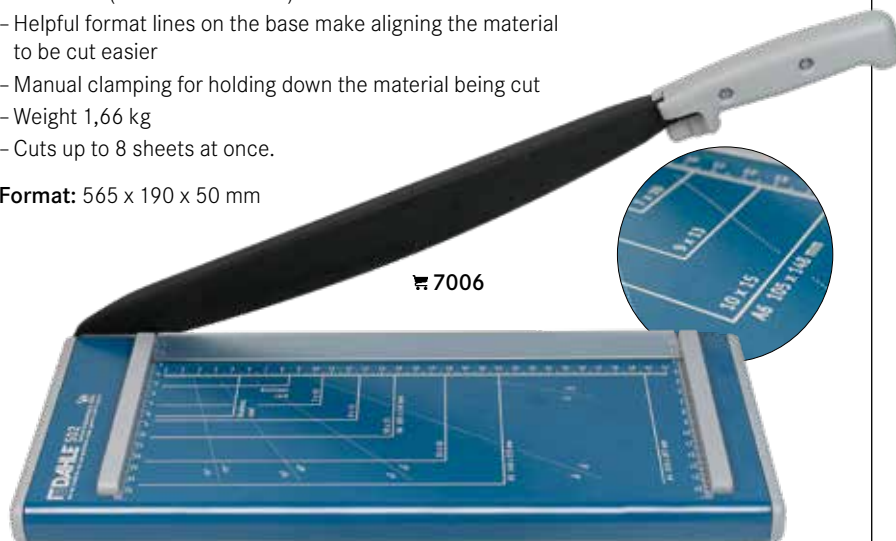

STOCKPAGES OMNIA

Stockpages Omnia with crystal clear strips on both sides offers a maximum of variants for collectors who like to collect a lot on one page. The different variety pages can be filled from both sides. The maximum width of the strips is 245 mm. The Stockpages Omnia (Format: 272 x 296 mm) are made of a hard-PVC-foil, free of acid and chemical softener. They are available in

black or white. They fit in all LINDNER ring binders with 18-ring perforation (Order no. 1104, 1102L, 1102Y, 1120, SRS and 1100).

Base film: black/white 300 my, Transparent strips: 100 my

● = Stockpages Omnia black

○ = Stockpages Omnia white



1 strip
Pocket height
293 mm

- 01
- 01P (Pack of 10)
- 09
- 09P (Pack of 10)



2 strips
Pocket height
140 mm

- 02
- 02P (Pack of 10)
- 010
- 010P (Pack of 10)



3 strips
Pocket height
91 mm

- 03
- 03P (Pack of 10)
- 011
- 011P (Pack of 10)



4 strips
Pocket height
67 mm

- 04
- 04P (Pack of 10)
- 012
- 012P (Pack of 10)



5 strips
Pocket height
52 mm

- 05
- 05P (Pack of 10)
- 013
- 013P (Pack of 10)



6 strips
Pocket height
43 mm

- 06
- 06P (Pack of 10)
- 014
- 014P (Pack of 10)



7 strips
Pocket height
34 mm

- 07
- 07P (Pack of 10)
- 015
- 015P (Pack of 10)



8 strips
Pocket height
30 mm

- 08
- 08P (Pack of 10)
- 016
- 016P (Pack of 10)



4 strips
Pocket height
3x 43 and 1x 141 mm

- 081
- 081P (Pack of 10)
- 0161
- 0161P (Pack of 10)



4 vertical and 6 horizontal
pockets
Pocket height
95 x 143 mm
Suited for
10 old postcards

- 021
- 021P (Pack of 10)



Mint Sheet Page /
Larger page format
Suited for 2 Mint Sheets
262 x 305 mm

The double-sided, black page
holds 2 sheets up to the size
of 262 x 305 mm.

- 020
- 020P (Pack of 10)



8 pockets
Pocket height
120 x 66 mm
Suited for approval cards

- 040
- 040P (Pack of 10)
- 030
- 030P (Pack of 10)



Approval Cards
Format: 115 x 66 mm
Pack of 100

- 1 strip
- 031
- 2 strips
- 032

Pages 100% free
from chemical
softeners.

Made
in
Germany

Protective interleaving
Suited for Omnia-, Approval
Cards, Blank- and
dT-Blank-pages.
Material: Plastothen, free of
chemical softeners.
₳ 800 Pack of 20

Save money with the Omnia-advantage offer, see page 67.

CRYSTAL CLEAR POCKET PAGES

SELECTION – OPTIONS – ALTERNATIVES!

It is important for LINDNER to offer a wide selection of pages which offer a large variety of different uses. It is a commitment that we take seriously! Large or small, horizontal or vertical, strips or booklets – LINDNER always provides a large selection and countless options. Our crystal clear pocket

pages are made of an acid and softener-free, crystal clear hard-PVC-foil. Pages fit in all 18-ring binders (Order no. 1104, 1102L, 1102Y, 1120, SRS) and in ECO (Order no. 1100).



1 large pocket ¹⁾
240 x 290 mm

crystal clear, with black inserts

- 820
- 820P (Pack of 10)



2 pockets ¹⁾
240 x 140 mm

crystal clear, with black inserts

- 821
- 821P (Pack of 10)



3 pockets ¹⁾
240 x 90 mm

crystal clear, with black inserts

- 822
- 822P (Pack of 10)



3 horizontal strips ²⁾
242 x 90 mm

crystal clear, incl. black backing page

- 823
- 823P (Pack of 10)



4 horizontal strips ²⁾
242 x 65 mm

crystal clear, incl. black backing page

- 824
- 824P (Pack of 10)



5 horizontal strips ²⁾
242 x 50 mm

crystal clear, incl. black backing page

- 825
- 825P (Pack of 10)



10 pockets ²⁾
120 x 53 mm

crystal clear, incl. black backing page

- 725
- 725P (Pack of 10)

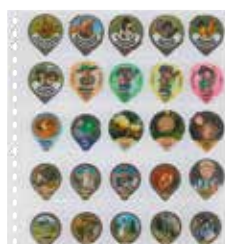

25 pockets ²⁾
46 x 55 mm

crystal clear, incl. white backing page

- 056*
- 056P* (Pack of 10)



8 horizontal strips ²⁾
242 x 30 mm

crystal clear, incl. black backing page

- 828
- 828P (Pack of 10)



6 vertical strips ²⁾
38 x 290 mm

crystal clear, incl. black backing page

- 836
- 836P (Pack of 10)

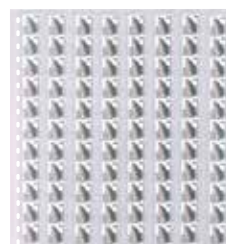

8 vertical strips ¹⁾
New design.
28 x 290 mm

crystal clear, incl. black backing page

- 848
- 848P (Pack of 10)

¹⁾ thin basic-foil
²⁾ thick basic-foil

Pages 100% free from chemical softeners.

Made in Germany

CRYSTAL CLEAR POSTCARD-PAGES



2 vertical and 3 horizontal pockets ²⁾
95 x 143 mm
Suited for 5 (10) old postcards

crystal clear, incl. black backing page

- 826
- 826P (Pack of 10)



4 vertical pockets ²⁾
114 x 146 mm
Suited for 4 (8) modern postcards

crystal clear, incl. black backing page

- 829
- 829P (Pack of 10)



1 pocket ¹⁾
240 x 290 mm
Suited for Share certificate, banknote

crystal clear, incl. black backing page

- 853
- 853P (Pack of 10)

crystal clear, incl. white backing page

- 833
- 833P (Pack of 10)



2 pockets ¹⁾
240 x 140 mm
Suited for Booklets, banknotes

crystal clear, incl. black backing page

- 850
- 850P (Pack of 10)

crystal clear, incl. white backing page

- 830
- 830P (Pack of 10)



3 pockets ¹⁾
240 x 90 mm
Suited for Booklets, banknotes

crystal clear, incl. black backing page

- 851
- 851P (Pack of 10)

crystal clear, incl. white backing page

- 831
- 831P (Pack of 10)



4 pockets ¹⁾
240 x 65 mm
Suited for Booklets, banknotes

crystal clear, incl. black backing page

- 852
- 852P (Pack of 10)

crystal clear, incl. white backing page

- 832
- 832P (Pack of 10)

RING BINDER FOR LINDNER PAGE FORMATS

Tested and sold hundreds of thousands of times and preferred by many stamp collectors. Our LINDNER ring binders represent quality, appearance and functionality. All ring binders are superbly manufactured and guarantee

convenient handling when turning pages. Removing or adding pages is especially easy - simply press the tabs on the top and bottom to open the 18-ring mechanism. Page lifters ensure that the pages lie flat at all times.



RING BINDER REGULAR

The deep, grainy leatherette material gives this ring binder an attractive appearance. The padded binder is equipped with: cover sheets, page lifters and an index window on the spine for identification purposes.

Slipcase for ring binder Regular (Order no. 1104), welded, in matching colour and special feature: cut out for easily removing of the ring binder.

Format Ring binder: 305 x 317 x 50 mm

Format Ring binder incl. Slipcase: 310 x 325 x 60 mm

Mechanism: 18-ring

1124 - G	1104 - G	814 - G
1124 - S	1104 - S	814 - S
1124 - B	1104 - B	814 - B
1124 - H	1104 - H	814 - H
1124 - W	1104 - W	814 - W



Made in Germany

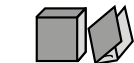

1120 - G
1120 - H
1120 - W

COMPANION SET: "EXCLUSIVE"

Handmade of the finest material: The outside of our ring binder is covered with a high-quality leatherette. The rounded corners and the gold embossing on the spine and front cover give each ring binder the most luxurious appearance. Cover sheets and page lifters included. Slipcase covered with leatherette in matching colours.

Format Ring binder: 305 x 317 x 50 mm

Mechanism: 18-ring

RING BINDER: "EXCLUSIVE LEATHER"

This padded ring binder is handmade of finest genuine leather. The exceptional quality in material and workmanship is truly impressive. Cover sheets and page lifters included.

Format Ring binder: 305 x 317 x 50 mm

Mechanism: 18-ring



1102L - G
1102L - S
1102L - B
1102L - H
1102L - W

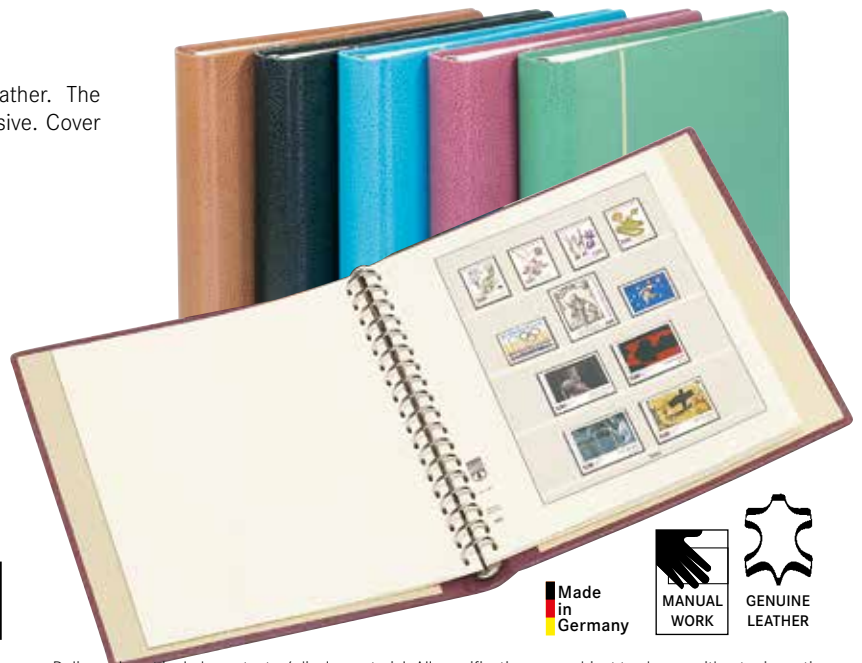

Accessories for LINDNER ring binders are found on page 95.



LINDNER
 Made in Germany

Approximate Capacity of the LINDNER ring binder:



- 50 LINDNER T-Illustrated pages / T-Blank-pages
- 45 LINDNER dT-Illustrated pages / dT-Blank-pages
- 35 Omnia or crystal clear pages
- 60 LINDNER Blank-pages

RING BINDER "STANDARD"

The "Standard" ring binder has been a firm favourite for our customers for many years. The padded ring binder is made of a smooth synthetic material called "Yorn" and is equipped with cover sheets, page lifters and an index window on the spine for identification purposes. Slipcase covered with leatherette in matching colours.

Format Ring binder: 305 x 317 x 50 mm

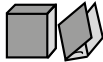
Mechanism: 18-ring

		
🛒 1122 - G	🛒 1102Y - G	🛒 810BY - G
🛒 1122 - S	🛒 1102Y - S	🛒 810BY - S
🛒 1122 - B	🛒 1102Y - B	🛒 810BY - B
🛒 1122 - H	🛒 1102Y - H	🛒 810BY - H
🛒 1122 - W	🛒 1102Y - W	🛒 810BY - W

LINDNER RING BINDER IN STAMP-DESIGN WITH 18-RING-MECHANISM, EMPTY

Padded LINDNER Ring binder made of synthetic-foil in stamp-design. Suitable for all pages in LINDNER page format with 18-ring hole punch.

Format Ringbinder: 305 x 317 x 50 mm

Mechanism: LINDNER 18-Ring



Made in Germany

Capacity:
 approx. 35-40 LINDNER Stockpages with 18-ring hole punch.



SLIPCASE RING BINDER ECO

The well proven LINDNER slipcase ring binder offers a lot of space for stockpages and for everything that can be stored in a ring binder. Thanks to the combination of a ring binder and a slipcase, your collection is always protected from all sides and stands safely on your shelf. The padded, grainy leatherette material offers a unique character. The slipcase ring binder ECO is available in 5 colours.

Features:

- Filling level: 30 mm
- Transparent cover sheets
- 2 cover sheets in corresponding colours
- Index window on the spine for description and identification

Format: 315 x 320 x 65 mm

Mechanism: 4-ring, 80/80/80 mm (Standard)

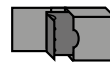

🛒 1100 - G
🛒 1100 - S
🛒 1100 - B
🛒 1100 - H
🛒 1100 - W



Made in Germany

Capacity:
 approx. 80 LINDNER T-Illustrated pages / T-Blank-pages
 approx. 65 LINDNER dt-Illustrated pages / dt-Blank-pages
 approx. 60 Omnia pages or crystal clear pages
 approx. 90 LINDNER Blank-pages

RING BINDER UNIVERSAL

Sturdy ring binder with black cover made of padded synthetic-foil. The grained surface in a leather-effect gives this ring binder its individual character. The standard mechanism allows an universal use. Includes 2 black cover sheets.

- Easy page turning due to ring mechanism.
- Hassle-free removal or exchange of pages.
- High capacity.
- Add other page versions as you like.

Format Ring binder: 305 x 317 x 50 mm

Mechanism: 4-ring, 80/80/80 mm (Standard)



Made in Germany



Capacity:
approx. 40 Protective sleeves / Stockpages

This ring binder can store all pages in LINDNER page format with 18-ring hole punch.

STOCKPAGE ALBUM SRS

Ring binder with 20 black stockpages for stamps, made of softener-free foil as well as 20 foil interleaves. The high-quality stockpages have 8 transparent strips per page (Order no. 08), can be filled on both sides and offer a neat solution for your collection.



BANKNOTE ALBUM SRS

Ring binder with 20 crystal clear pages for banknotes, made of softener-free foil, including 20 white cardboard interleaves. 10 of the pages have 2 pockets (Order no. 830) for banknotes up to a size of 240 x 140 mm and 10 of the pages have 3 pockets (Order no. 831) for banknotes up to a size of 240 x 90 mm.



POSTCARD ALBUM SRS

Ring binder with 20 crystal clear pages for postcards, made of softener-free foil (Order no. 829) as well as 20 black interleaves. The crystal clear pages have 4 vertical pockets (114 x 146 mm) for either 4 or 8 postcards if used on both sides.



FIRMO UNIVERSAL ALBUMS

The FIRMO Universal albums made of a high-quality leatherette cover offers plenty of space for banknotes, FDC's, letters, photos, postcards etc. The crystal clear synthetic sleeves with black paper inserts are made of PVC-foil and can be used from both sides. The pages open at the inner side so that the documents are protected from dirt and falling out. The albums are carefully produced and are characterised by their plain elegance.

FIRMO XL

With 56 crystal clear synthetic sleeves that can be used from both sides. The black paper inserts can be used as a divider.

For 224 items up to the size of 245 x 132 mm.

Format: 285 x 305 x 75 mm

🛒 812XL

FIRMO L

With 54 crystal clear synthetic sleeves that can be used from both sides. The black paper inserts can be used as a divider.

For 108 items up to the size of 245 x 132 mm.

Format: 285 x 155 x 75 mm

🛒 812L



POCKET ALBUM FOR BANKNOTES

Handy pocket album with padded dark blue synthetic cover. With 20 crystal clear sleeves. Ideal for e.g. banknotes, postcards or other receipts or documents.



● 812XL-R
● 812XL-B
● 812XL-S



● 812L-R
● 812L-B
● 812L-S



● 812-R
● 812-B
● 812-S

FIRMO

With 54 crystal clear synthetic sleeves that can be used from both sides. The black paper inserts can be used as a divider.

For 108 items up to the size of 190 x 130 mm.

Format: 230 x 155 x 75 mm

🛒 812



● S818

● S817

Format: 230 x 155 x approx. 20 mm
Suited for: Banknotes, documents up to 210 x 125 mm.

🛒 S818

Format: 195 x 110 x approx. 20 mm
Suited for: Banknotes, documents up to 175 x 85 mm.

🛒 S817

STOCKBOOKS



STOCKBOOKS "STANDARD"

Interleaving pages: double, glassine. Cover: leatherette, unpadding.

Format	pages	Glassine strips	Linen joint		🛒				
230 x 305 mm	16	10 regular	simple	1160 -	G	S	B	H	R
	32	10 regular	double	1161 -	G	S	B	H	R
	48	10 regular	double	1162 -	G	S	B	H	R
	64	10 regular	double	1163 -	G	S	B	H	R
	64	10 divided	double	1167 -	G	S	B	H	R



Transparent strips

Format	pages	Transparent strips	Linen joint		🛒				
230 x 305 mm	32	9 regular	double	1168 -	G	S	B	H	R
	48	9 regular	double	1169 -	G	S	B	H	R
	64	9 regular	double	1170 -	G	S	B	H	R

Interleaving pages: single, glassine. Cover: leatherette, unpadding.



Format	pages	Transparent strips	Linen joint		🛒				
165 x 220 mm	16	6 regular	simple	1158 -	G	S	B	H	R
	32	6 regular	simple	1159 -	G	S	B	H	R



STOCKBOOKS "LOTOS"

Interleaving pages: double, glassine. Cover: leatherette, unpadding.

Format	pages	Transparent strips	Linen joint		🛒	
230 x 305 mm	16	9 regular	double	5701 -	B	R
	32	9 regular	double	5702 -	B	R

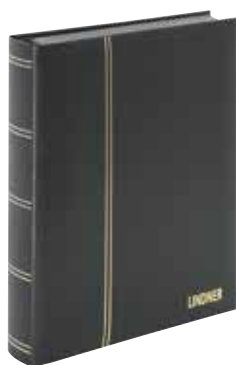

STOCKBOOK ELEGANT "LEATHER"

Interleaving pages: double, foil. Cover: leather, padding.

Format	pages	Transparent strips	Linen joint		🛒
230 x 305 mm	60	9 regular strips	double	1185L -	S

STOCKBOOKS "ELEGANT" 60 PAGES

Interleaving pages: double, glassine. Cover: leatherette, padding.

Format	pages	Glassine strips	Linen joint		🛒				
230 x 305 mm	60	10 regular	double	1162S -	G	S	B	H	R
				Stockbooks "Elegant" + Slipcase	1162SK -	G	S	B	H
230 x 305 mm	60	9 regular	double	1169S -	G	S	B	H	R
				Stockbooks "Elegant" + Slipcase	1169SK -	G	S	B	H

MATCHING SLIPCASE made of laminated cardboard in matching colour.

240 x 320 x 65 mm	Slipcase, empty			116K -	G	S	B	H	R
-------------------	-----------------	--	--	--------	---	---	---	---	---

STOCKBOOKS “DIAMANT”

Interleaving pages: double, foil.

Format	pages	Transparent strips	Linen joint	
230 x 305 mm	60	9 regular	double	1195 - G* S* B*

The high-class cover material with its white decorative stitching is the perfect match for the well tried stockbook pages. DIAMANT is the album that you enjoy working with and that also looks impressive on your desk or on the shelf.



STOCKBOOKS “ELEGANT” 64 PAGES

Interleaving pages: double, glassine. Cover: leatherette, padded.

Format	pages	Glassine strips	Linen joint	
230 x 305 mm	64	10 regular	double	1175 - S B R

Transparent strips				
Format	pages	Transparent strips	Linen joint	
230 x 305 mm	64	9 regular	double	1179 - S B R



STOCKBOOKS “ELEGANT NUBUK”

Interleaving pages: double, foil. Cover: leatherette, padded.

Format	pages	Transparent strips	Linen joint	
230 x 305 mm	60	9 regular	double	1180 - G* S* B* H* R*
	60	9 regular	double	1181 - G S B H R

Many collectors will be pleased to see this line of high-quality stockbooks in our program. Quality workmanship and materials make these stockbooks exceptional. Padded stockbooks are made with a special leatherette material called NUBUK-Fiore. Both stockbooks are double linen hinged and have crystal clear double interleaving.



STAMP ALBUM WITH SCREW MECHANISM

Ring binder made of padded PVC-foil. Comes with 10 stockpages made of black cardboard.

Format	pages	Transparent strips	Linen joint	
280 x 310 x 50 mm	10	6 regular	double	1190 - G S B R

STOCKPAGES

Crystal clear strips on both sides and clear cover page on the front. Pages with 6 hole punching. 10 pages per package.

Format	Material	Transparent strips	Linen joint	
265 x 290 mm	Card	6 regular	double	1171F
		10 regular	double	1172F

Suited for: Stamp album with screw mechanism.



MULTI COLLECT - SYSTEM

VERSATILE COLLECTING WITH OUR MULTI-TALENTED SYSTEM

Versatile collecting with our multi-purpose album system. This album rightly deserves its name – every collector can find a large assortment of pages with a wide variety of pocket sizes which provides different types of collections.

Whether you collect stamps, sheetlets, FDCs, ETBs, year books, booklets, postcards, banknotes, coins or phone cards: Our Multi collect-system has a place for everything! The typical 4-ring mechanism of the padded Multi collect-ring binder guarantees easy handling and impresses with a large capacity. A plastic window on the spine provides space for identification labels/description of contents.

We offer ring binders which differ in size, colour and storage capacity.

Fitting ring binders are found on page 42-43.



Made in Germany

BLANK PAGES

With 4-ring perforation
Size PUBLICA M: 210 x 255 mm
Material: 200 g/qm

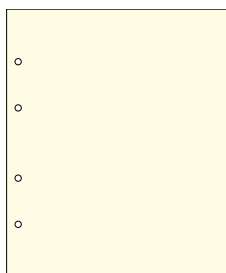

Made in Germany

Blank pages
210 x 255 mm

€ 803o
(Pack of 10)



1 pocket
190 x 253 mm

Pack of 10
● MU1311
○ MU1321

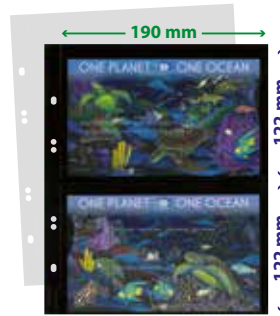

2 strips
190 x 122 mm

Pack of 10
● MU1312
○ MU1322

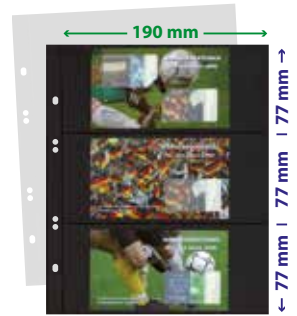

3 strips
190 x 77 mm

Pack of 10
● MU1313
○ MU1323

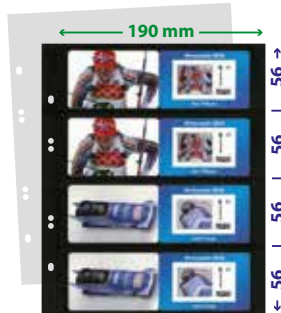

4 strips
190 x 56 mm

Pack of 10
● MU1314
○ MU1324



5 strips
190 x 43 mm

Pack of 10
● MU1315
○ MU1325

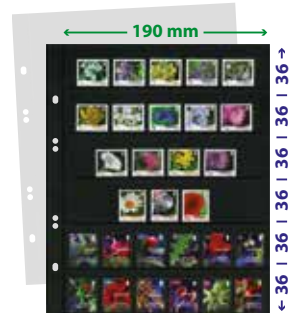

6 strips
190 x 36 mm

Pack of 10
● MU1316
○ MU1326

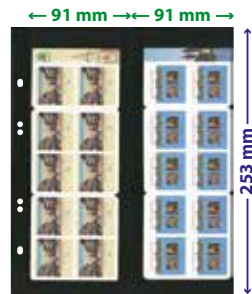

2 vertical strips
91 x 253 mm

Pack of 10
● MU1317



4 strips
190 x 36 mm (3x)
190 x 121 mm (1x)

Pack of 10
● MU1319



1 pocket
151 x 235 mm

Pack of 10
● MU1330
○ MU1340



2 strips
152 x 112 mm

Pack of 10
● MU1331
○ MU1341

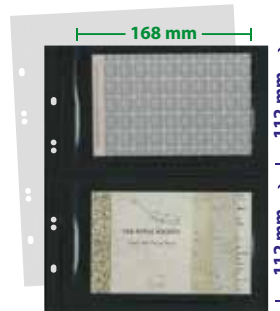

2 strips
168 x 112 mm

Pack of 10
● MU1332
○ MU1342

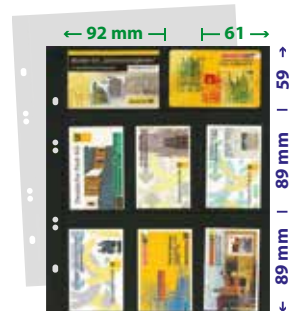

8 pockets
92 x 59 mm (2x)
61 x 89 mm (6x)

Pack of 10
● MU1353
○ 1363* 2)

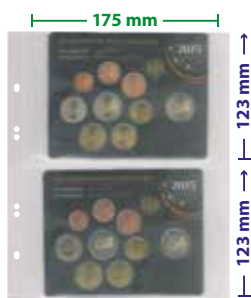

2 pockets
175 x 123 mm
2 sets Euro-coins Germany
proof
Pack of 10
○ MU1363



8 pockets
93 x 56 mm
REBECK COIN L Coin holders/
Telephone cards,
Coin-Cards
Pack of 10
○ MU1364



1 pocket
180 x 207 mm
current coin sets in blister
Pack of 10
○ MU1392

MULTI COLLECT-PAGES

The **one-sided**, crystal clear Multi collect-pages are made of softener and acid-free hard-PVC-foil. You can view the front and back of the items that are placed in these pages.

The **double-sided**, black Multi collect-pages are made of archival safe hard-PVC, that is free of acids and chemical softeners to ensure long term preservation and presentation.

Format: 210 x 255 mm



1 pocket
185 x 250 mm
one pocket with black insert
Pack of 10
○ MU1405



2 pockets
185 x 120 mm
two pockets with black inserts
Pack of 10
○ MU1404



3 pockets
185 x 80 mm
three pockets with black inserts
Pack of 10
○ MU3103

MULTI COLLECT-PAGES FOR BANKNOTES

The Multi collect-pages made of crystal-clear, softener and acid-free hard-PVC-foil with black foil insert strips can be filled twice. The foil insert strips are removable. This offers the possibility to fill the pockets with just one receipt and the front and back of the contents can be viewed.

Format: 210 x 255 mm



12 pockets Ø 50 mm
Pack of 5
Interleaving black
● MU12 ³⁾
Interleaving red
● MU12R ³⁾



15 pockets Ø 42 mm
Pack of 5
Interleaving black
● MU15
Interleaving red
● MU15R



24 pockets Ø 34 mm
Pack of 5
Interleaving black
● MU24
Interleaving red
● MU24R

MULTI COLLECT-COIN PAGES

Our **crystal clear Multi collect-coin pages** provide neat and safe storage of your coin collection. Simply remove the plastic strip from the page and insert the coins in the individual compartments. Once it is filled, insert the strip back into the page. The pages are easily removed, added or changed.

Format: 202 x 252 mm

³⁾ Made in EU



35 pockets Ø 27 mm
Pack of 5
Interleaving black
● MU35
Interleaving red
● MU35R



5x €-coin set
Pack of 5
Interleaving black
● MU40
Interleaving red
● MU40R



54 pockets Ø 20 mm
Pack of 5
Interleaving black
● MU54
Interleaving red
● MU54R

INTERLEAVING PAGES

(Format: 210 x 255 mm)

Interleaves are recommended for interleaving purposes.

Pack of 20, crystal clear
○ MU1385

Interleaving black

Pack of 5
● MUZ
Pack of 10
● MU1386

Interleaving red
Pack of 5
● MUZR

MULTI COLLECT - RING BINDER REGULAR CLASSIC

Ring binder made of padded synthetic-foil. The grained surface in leather-effect gives the ring binder its individual character. The typical 4-ring mechanism of the Multi collect-ring binder guarantees a simple handling and the ring binder impresses with its large capacity. The generous spine window offers space for content listing.

Matching pages see page 78-79.

Format Ring binder: 245 x 270 x 80 mm

Format Ring binder incl. Slipcase: 250 x 280 x 85 mm

Mechanism: 4-ring, 40/80/40 mm



See our Multi Collect complete album for postcards on page 85.

Made in Germany

1302 - G	1300 - G	1301 - G
1302 - S	1300 - S	1301 - S
1302 - B	1300 - B	1301 - B
1302 - H	1300 - H	1301 - H
1302 - W	1300 - W	1301 - W



Capacity:
 approx. 20 Multi collect-coin pages
 approx. 60 Multi collect-stockpages – black
 approx. 80 Multi collect-stockpages – crystal clear

RING BINDER RONDO REGULAR COMPACT

Ring binder made of padded synthetic-foil. The rounded spine and grained surface gives the ring binder its classical look. The spine window offers space for content listing.

Matching pages see page 78-79.

Format: 235 x 270 x 40 mm

Format Ring binder incl. Slipcase: 245 x 280 x 45 mm

Mechanism: 4-ring, 40/80/40 mm



Made in Germany



1402 - G	1400 - G	1401 - G
1402 - S	1400 - S	1401 - S
1402 - B	1400 - B	1401 - B
1402 - H	1400 - H	1401 - H
1402 - W	1400 - W	1401 - W



See our FDC complete album "REGULAR" on page 83.

Capacity:
 approx. 35 Multi collect-stockpages – black
 approx. 50 Multi collect-stockpages – crystal clear

RING BINDER PUBLICA M COLOR







The large capacity enhances the modern and fresh appearance of these high-quality, padded ring binders. The robust and sturdy material guarantee an extensive durability of this ring binder. The standard mechanism allows it to be used universally. A pocket on the inside of the binder offers room for content labelling. Matching pages see page 78-79.

Format Ring binder: 245 x 270 x 60 mm
Format Ring binder incl. Slipcase: 250 x 280 x 75 mm
Mechanism: 4-ring, 45/65/45 mm



Made in Germany

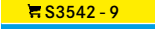

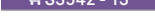
-   S3542 - 1
-  S3542 - 9
-  S3542 - 5
-  S3542 - 4
-  S3542 - 13

Capacity:
 approx. 15 Multi collect-coin pages
 approx. 50 Multi collect-stockpages – black
 approx. 70 Multi collect-stockpages – crystal clear



Made in Germany



Please note the PUBLICA-M album for coins (Order no. 3532M) on page 43.

RING BINDER PUBLICA M

A SPACE-SAVING, SAFE AND ATTRACTIVE RING BINDER FOR COINS AND BANKNOTES















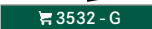

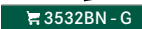
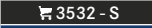
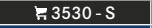

The high-quality ring binder from the PUBLICA series offers a uniform, classical and timeless design. The sturdy construction and the quality materials selected for this ring binder guarantee many years of use. The padded leatherette cover has a 4-ring mechanism and is also available with a matching slipcase. A large, clear index window on the spine allows you to insert a description for easy identification of the contents. Matching pages see page 78-79.

The sturdy slipcase, that is optionally available, protects the album and its contents. It stands safely on the shelf or cupboard.

Format Ring binder: 245 x 270 x 60 mm
Format Ring binder incl. Slipcase: 250 x 280 x 75 mm
Mechanism: 4-ring, 45/65/45 mm

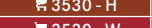
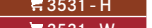
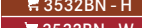
PUBLICA M BANKNOTE ALBUM FOR UP TO 80 BANKNOTES/POSTCARDS

PUBLICA M ring binder comes with 20 crystal clear Multi collect-pages Order no. MU1404 to hold banknotes, postcards or other collectibles. The page can hold either 2 or 4 items, depending upon your preference. The pockets have black inserts which can be easily removed making both sides of the collectible visible.

			
 3532 - G	 3530 - G	 3531 - G	 3532BN - G
 3532 - S	 3530 - S	 3531 - S	 3532BN - S
 3532 - B	 3530 - B	 3531 - B	 3532BN - B
 3532 - H	 3530 - H	 3531 - H	 3532BN - H
 3532 - W	 3530 - W	 3531 - W	 3532BN - W

UNIPLATE

Where quality meets value! The UNIPLATE System was developed many years ago for the US market and offers two different 3-ring binders. Functionality and economical pricing made this system a huge success. Choose between the "Standard" or "Luxus" ring binder and select any UNIPLATE stockpages shown on this page. Whether you collect stamps, sheetlets, FDC's, ETB's, booklets, postcards or banknotes - our UNIPLATE System offers a safe storage solution for almost any collectible. Use the album the way you collect - with UNIPLATE the choice is yours.

1 UNIPLATE RING BINDER "STANDARD"

Standard ring binder, made of a blue vinyl material with a smooth, unpaddinged surface. Available with or without a matching slipcase.

2 UNIPLATE RING BINDER "LUXUS"

Luxus Ring binder in winered, made of an attractive, padded leatherette material. Available with or without a matching slipcase.

Format Ring binder: 270 x 295 x 65 mm

Mechanism: 3-ring, 110/110 mm

1712	1710	1711
1702	1700	1701

UNIPLATE STOCKPAGES

The UNIPLATE stockpages are made for our 3-ring system and offers top quality protection and presentation at a reasonable price. The UNIPLATE pages have numerous page options - from one large pocket up to 8 individual strips. The pages are available either double-sided black or one-sided crystal clear. UNIPLATE stockpages are made of high-quality hard-PVC which is 100 % free of any chemical softeners. The pages fit in our 3-ring binders Order no. 1700 (Standard) and 1710 (Luxus).

The black UNIPLATE page variations can be used on both sides.

The transparent UNIPLATE page variations can only be used on one side. This way the content can be viewed from both its back and front side.

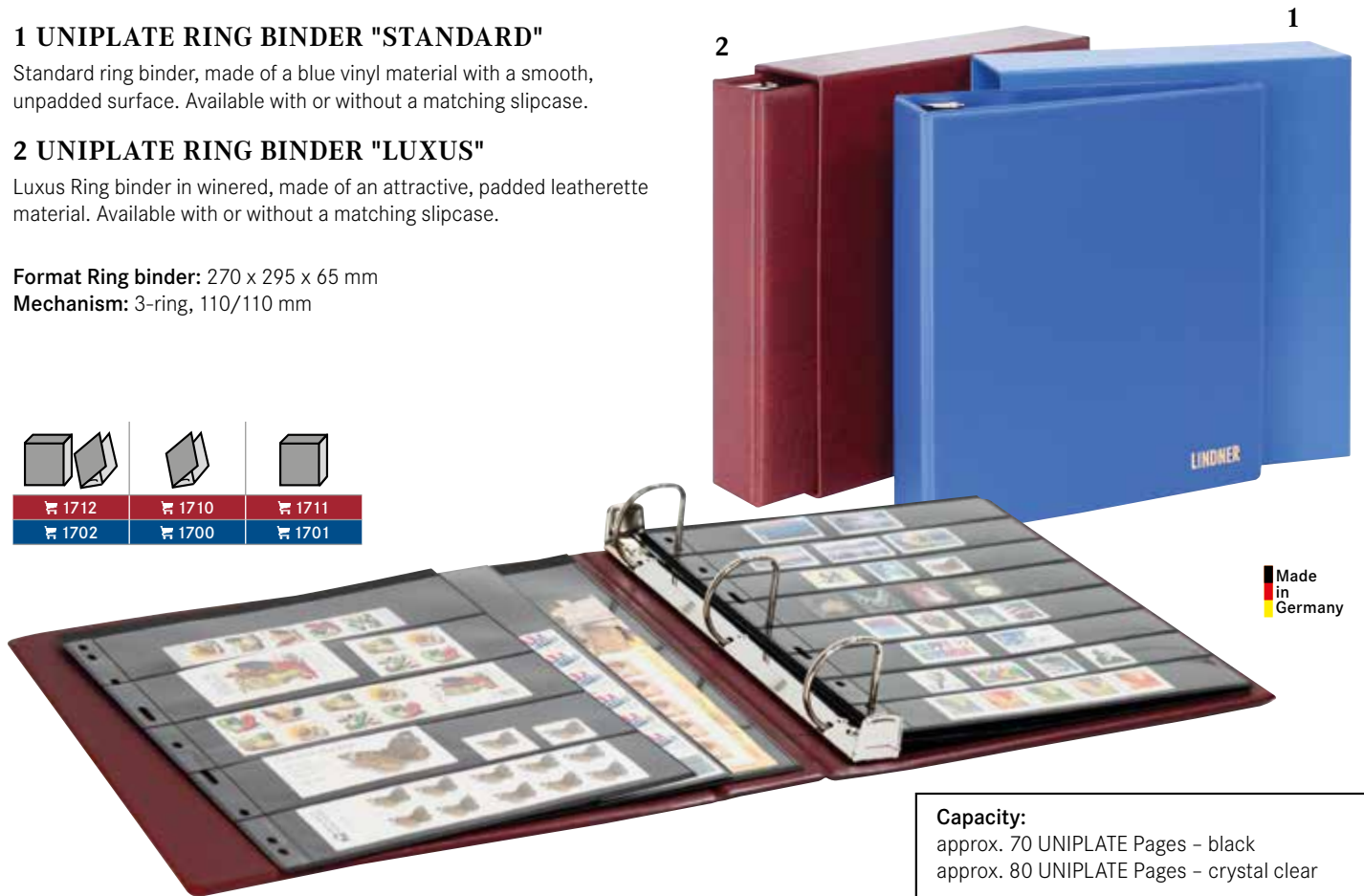

Capacity:
 approx. 70 UNIPLATE Pages - black
 approx. 80 UNIPLATE Pages - crystal clear

1 strip 258 x 197 mm ● 071 ○ 091 (Pack of 10)	2 strips 128 x 197 mm ● 072 ○ 092 (Pack of 10)	3 strips 84 mm x 197 mm ● 073 ○ 093 (Pack of 10)	4 strips 63 x 197 mm ● 074 ○ 094 (Pack of 10)	5 strips 48 x 197 mm ● 075 (Pack of 10)	6 strips 39 x 197 mm ● 076 (Pack of 10)	7 strips 33 x 197 mm ● 077 (Pack of 10)
					Pages 100% free from chemical softeners.	
8 strips 26 x 197 mm ● 078 (Pack of 10)	4 pockets 128 x 97 mm ● 079 ○ 099 (Pack of 10)	2 strips 276 x 122 und 70 mm ● 062 ○ 082 (Pack of 10)	3 strips 276 x 61, 62 und 63 mm ● 063 ○ 083 (Pack of 10)	5 strips 276 x 38, 36 und 35 mm ● 065 ○ 085 (Pack of 10)	● black (double-sided) Pack of 5 ○ crystal clear Pack of 5	

1786 Black cardboard interleaving pages for crystal clear stockpages, pack of 5.



Supplement pages and a lot of suitable page variations for this ring binder you can find on page 78-79.



Additional pages: Pack of 10

- ☛ MU1404 two pockets including two black inserts to hold items up to size 185 x 120 mm.
- ☛ MU1405 one pocket including one black insert to hold items up to size 185 x 250 mm.

FDC ALBUM RONDO REGULAR

Ring binder made of padded synthetic-foil. The rounded spine and grained surface gives the ring binder its classical look. The spine window offers space for content listing.

Comes with 10 transparent pages with two pockets (Order no. MU1404).

Format Ring binder: 235 x 270 x 40 mm

Mechanism: 4-ring, 40/80/40 mm

Capacity: approx. 35 pages

☛ 1403 - G	☛ 1402 - G	☛ 1400 - G	☛ 1401 - G
☛ 1403 - S	☛ 1402 - S	☛ 1400 - S	☛ 1401 - S
☛ 1403 - B	☛ 1402 - B	☛ 1400 - B	☛ 1401 - B
☛ 1403 - H	☛ 1402 - H	☛ 1400 - H	☛ 1401 - H
☛ 1403 - W	☛ 1402 - W	☛ 1400 - W	☛ 1401 - W



Additional pages: Pack of 10

- ☛ 819 One pocket: DIN A5 / 148 x 210 mm (Format: 174 x 216 mm).

ETB-ALBUM CLASSIC

Ring binder in high-quality, made of padded synthetic-foil with spine window for content labelling. Comes with 20 transparent pages size DIN A5 (Order no. 819) made of softener and acid free, transparent hard-PVC-foil.

Format Ring binder: 200 x 235 x 40 mm

Mechanism: 13-ring

Capacity: approx. 40 transparent pages

☛ 1103E - G	☛ 1130 - G	☛ 1103Y - G	☛ 810CY - G
☛ 1103E - S	☛ 1130 - S	☛ 1103Y - S	☛ 810CY - S
☛ 1103E - B	☛ 1130 - B	☛ 1103Y - B	☛ 810CY - B
☛ 1103E - W	☛ 1130 - W	☛ 1103Y - W	☛ 810CY - W



Additional pages: Pack of 50

- ☛ 5601 One pocket: DIN A5 / 148 x 210 mm (Format: 168 x 218 mm).

☛ 5600 - G
☛ 5600 - S
☛ 5600 - H
☛ 5600 - W
☛ 5600 - B

ETB-ALBUM LOTOS

First Day Sheet Album with 50 crystal clear pages which are free of any chemical softeners. Padded 4-ring binder which has gold embossed logo on front cover and spine, plus gold stripes on the spine.

Format Ring binder: 194 x 228 x 50 mm

Mechanism: 4-ring, 45/65/45 mm

Capacity: approx. 80 pages

FDC ALBUM "SMALL"

Padded vinyl binder to hold 100 documents up to size 190 x 125 mm thin continental type.

External measurements:

240 x 145 x 55 mm

1	
☛ 816 - G	☛ 816K - G
☛ 816 - S	☛ 816K - S
☛ 816 - B	☛ 816K - B
☛ 816 - R	☛ 816K - R



FDC ALBUMS "SMALL" IN LONG FORMAT

Padded vinyl binder to hold 100 documents up to size 240 x 125 mm thin continental type.

External measurements:

285 x 145 x 55 mm

2	
☛ 817 - G	☛ 817K - G
☛ 817 - S	☛ 817K - S
☛ 817 - B	☛ 817K - B
☛ 817 - R	☛ 817K - R



For storing First Day Sheets from Germany and West Berlin in our ring binders Order no. 1104, 1102L, 1102Y, 1104 and SRS we suggest using the LINDNER T-Blank-page Order no. 802104.

POSTCARD ALBUMS XL



RING BINDER PUBLICA XL

Ring binder in black, made of padded synthetic-foil for a space-saving, secure and representative storage of collectibles. The generous spine window offers plenty of space for content labelling. Fits our postcard pages XL.

Format Ring binder: 390 x 345 x 60 mm
Mechanism: 4-ring, 80/80/80 mm (Standard)

RING BINDER STANDARD XL

The ring binder "Standard" has been a long time staple in our product line! The album is made of a padded, smooth vinyl with an index window on the spine.

Format Ring binder: 390 x 345 x 60 mm
Format Ring binder incl. Slipcase: 400 x 360 x 70 mm
Mechanism: 4-ring, 80/80/80 mm (Standard)

Capacity:

- approx. 50 Postcard pages XL – black
- approx. 50 Postcard pages XL – grey
- approx. 70 Postcard pages XL – crystal clear

POSTCARD PAGES XL

The transparent page variations can be filled on one side. This way the content can be viewed from both its back and front side. The black and

grey page variations can be filled on both sides and offer a maximum of space.

Format: 350 x 335 mm

	black		grey		crystal clear		
	1x	10x	1x	10x	1x	10x	Postcard pages
1	3050	3050P	3010*	3010P*	3060	3060P	Horizontal, for 2x 6 postcards up to 165 x 105 mm.
2	3051	3051P	3011*	3011P*	3061	3061P	Vertical, for 2x 6 postcards up to 108 x 160 mm.
3	3052	3052P	3013*	3013P*	3062	3062P	Without dividers, inside dimension 330 x 330 mm.
4	---	---	3012*	3012P*	---	---	For 2x 5 cards (3x horizontal and 2x lateral) up to 108 x 160 mm.
5	---	---	3021*	3021P*	---	---	Vertical, for 2x 6 postcards up to 90 x 140 mm.
6	---	---	3022*	3022P*	---	---	For 2x 5 cards (3x horizontal and 2x lateral) up to 90 x 140 mm.

3560Z Black Interleaving for crystal clear pages, Pack of 10

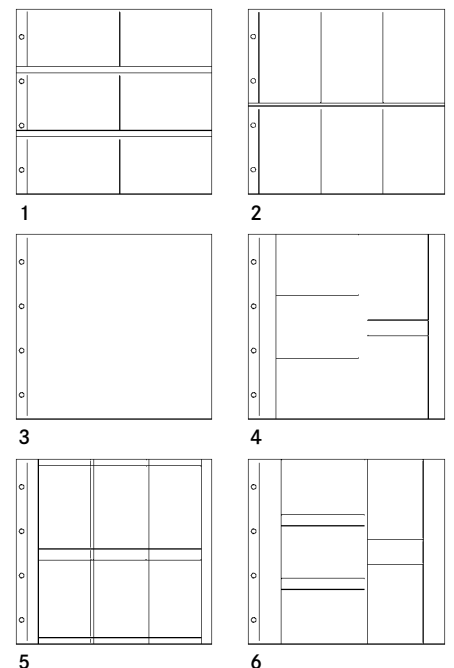

For storing postcards in 18-ring binders we suggest using the transparent pages Order no. 826 and 829 as well as the Omnia page Order no. 021 (see page 70 and 71).

*Delivery only while stocks last.

Delivery do not include contents / display material. All specifications are subject to change without prior notice.

MULTI COLLECT-POSTCARD ALBUM

Multi collect-ring binder (Order no. 1300) incl. 30 double-sided, black postcard pages (Order no. MU1312).

- Large capacity (up to 60-70 pages for postcards)
- Wide spine with index window
- Multifunctional and versatile – other page options for coins, stamps, banknotes, etc. are available!

Format Ring binder: 245 x 270 x 80 mm

Mechanism: 4-ring, 40/80/40 mm

Capacity: approx. 40 Postcard pages (Order no. MU1312)

🛒 1300PK - G	🛒 1301 - G
🛒 1300PK - S	🛒 1301 - S
🛒 1300PK - B	🛒 1301 - B
🛒 1300PK - H	🛒 1301 - H
🛒 1300PK - W	🛒 1301 - W

Details as well as other possibilities for using our versatile Multi collect-system are found on page 78-79.



Made in Germany

Additional pages: Pack of 10
🛒 MU1312 Multi collect Postcard pages

POSTCARD ALBUM CLASSIC

This high-quality album is made of an elegant padded, leatherette material plus a clear index window on the spine. This album comes with 20 crystal clear, 2-pocket pages, (Order no. 811) to hold items size 155 x 110 mm.

Format Ring binder: 200 x 235 x 40 mm

Mechanism: 13-ring

Capacity: approx. 35 Postcard pages (Order no. 811)

🛒 1103K - G	🛒 1131 - G	🛒 1103Y - G	🛒 810CY - G
🛒 1103K - S	🛒 1131 - S	🛒 1103Y - S	🛒 810CY - S
🛒 1103K - B	🛒 1131 - B	🛒 1103Y - B	🛒 810CY - B
🛒 1103K - W	🛒 1131 - W	🛒 1103Y - W	🛒 810CY - W



Made in Germany

Additional pages: Pack of 10
🛒 811 2 pockets: 155 x 110 mm (Format: 174 x 224 mm).

POSTCARD ALBUM LOTOS

Postcard album incl. 50 transparent pages with 2 pockets (150 x 107 mm) made of softener and acid-free foil. Padded ring binder with embossed gold logo on the cover and spine, as well as gold stripes on the spine.

Format Ring binder: 194 x 228 x 50 mm

Mechanism: 4-ring, 45/65/45 mm

Capacity: approx. 50 Postcard pages (Order no. 5801)

🛒 5800 - G
🛒 5800 - S
🛒 5800 - B
🛒 5800 - H
🛒 5800 - W



Made in Germany

Additional pages: Pack of 50
🛒 5801
2 pockets: 150 x 107 mm (Format: 170 x 221 mm).

For storing postcards in 18-ring binders we suggest using the transparent pages Order no. 826 and 829 as well as the Omnia page Order no. 021 (see page 70 and 71).

RING BINDER SERIES PUBLICA

THE RIGHT FORMAT FOR EVERY COLLECTION

The high-quality ring binders from our PUBLICA series have a uniform, classical and timeless look. Time tested, durable materials guarantee many years of use. The padded, grained leatherette gives the ring binder its unique character. Each size – PUBLICA is designed for a different style and size of page to fit a variety of collections. Whether you collect coins, stamps, banknotes, FDC's or postcards – the PUBLICA series offers a storage solution for you. All binders come in black, with the LS & M series also available in other colours. The wide spine offers lots of room and a synthetic window provides space for identification labels/description of the contents.



Made in Germany

XL

LS

M

S



KARAT

Made in Germany



RING BINDER PUBLICA S

Black, ring binder made of padded synthetic foil for space-saving, secure and attractive storing. A synthetic window on the spine provides space for labels. This binder is suitable for our karat-coin pages.

Format: 225 x 240 x 60 mm

Mechanism: 4-ring, 45/65/45 mm

Capacity: about 25 karat-coin pages depending on the size of the coins



3520

Suitable for our karat-coin pages see page 32.

RING BINDER PUBLICA M

A SPACE-SAVING, SAFE AND ATTRACTIVE RING BINDER FOR COINS AND BANKNOTES

The high-quality ring binder from the PUBLICA series offers a uniform, classical and timeless design. The sturdy construction and the quality materials selected for this ring binder guarantee many years of use. The padded leatherette cover has a 4-ring mechanism and is also available with a matching slipcase. A large, clear index window on the spine allows you to insert a description for easy identification of the contents. Matching pages see page 78-79.

Format Ring binder: 245 x 270 x 60 mm

Format Ring binder incl. Slipcase: 250 x 280 x 75 mm

Mechanism: 4-ring, 45/65/45 mm

Capacity:

approx. 15 Multi collect-coin pages

approx. 50 Multi collect-stockpages – black

approx. 70 Multi collect-stockpages – crystal clear

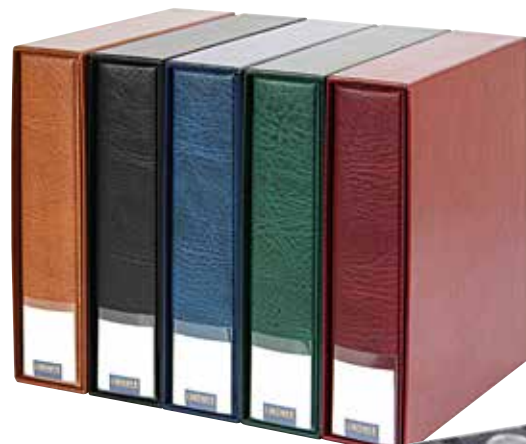

Made in Germany



3532 - G

3532 - S

3532 - B

3532 - H

3532 - W



3530 - G

3530 - S

3530 - B

3530 - H

3530 - W



3531 - G

3531 - S

3531 - B

3531 - H

3531 - W

PUBLICA M COLOR



The large capacity enhances the modern and fresh appearance of these high-quality, padded ring binders. The robust and sturdy material guarantee an extensive durability of this ring binder. The standard mechanism allows it to be used universally. A pocket on the inside of the binder offers room for content labeling. Matching pages see page 78-79.

Format Ring binder: 245 x 270 x 60 mm

Format Ring binder incl. Slipcase:
250 x 280 x 75 mm

Mechanism: 4-ring, 45/65/45 mm



- S3542 - 1
- S3542 - 9
- S3542 - 5
- S3542 - 4
- S3542 - 13



Made
in
Germany

"READY-TO-USE" ALBUMS

BANKNOTE ALBUM

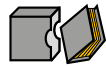

- S3542BN - 1
- S3542BN - 9
- S3542BN - 5
- S3542BN - 4
- S3542BN - 13

The album comes with 10 double-sided Multi collect-stock pages in 2 sizes (Order no. MU1404 and MU3103).

STOCKPAGE ALBUM



- S3542B - 1
- S3542B - 9
- S3542B - 5
- S3542B - 4
- S3542B - 13

The album comes with 10 double-sided Multi collect-stock pages for stamps in 2 sizes (Order no. MU1315 and MU1316).

PHOTO ALBUM / POSTCARD ALBUM

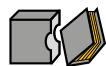

- S3542PK - 1
- S3542PK - 9
- S3542PK - 5
- S3542PK - 4
- S3542PK - 13

The album comes with 10 double-sided Multi collect-stock pages (Order no. MU1404).

COIN ALBUM



- S3542M - 1
- S3542M - 9
- S3542M - 5
- S3542M - 4
- S3542M - 13

The album comes with 10 Multi collect-coin pages in 5 sizes (Order no. MU15, MU24, MU35, MU54 and MU40).

EVERY ALBUM CAN BE FILLED UP WITH FURTHER PAGES!

The LINDNER Multi collect-system offers a wide selection of high-quality stockpages with many different variations of pockets and almost endless possibilities. See on page 78-79.

PUBLICA LS

Format: 290 x 315 x 60 mm

Format Ring binder incl. Slipcase:
295 x 325 x 70 mm

Ring binder made of padded synthetic-foil with standard mechanism.

For space-saving, safety and representative storing. The large index-window on the spine offers space for content labeling.

Suitable for our stockpages A4 and other pages in DIN A4 format with standard hole punch.

Mechanism: 4-ring, 80/80/80 mm (Standard)

Made in Germany

Capacity:
approx. 50 stockpages – black
approx. 70 stockpages – crystal clear
approx. 5 Champagne lid pages

3533 - G	3503 - G	3504 - G
3533 - S	3503 - S	3504 - S
3533 - B	3503 - B	3504 - B
3533 - H	3503 - H	3504 - H
3533 - W	3503 - W	3504 - W

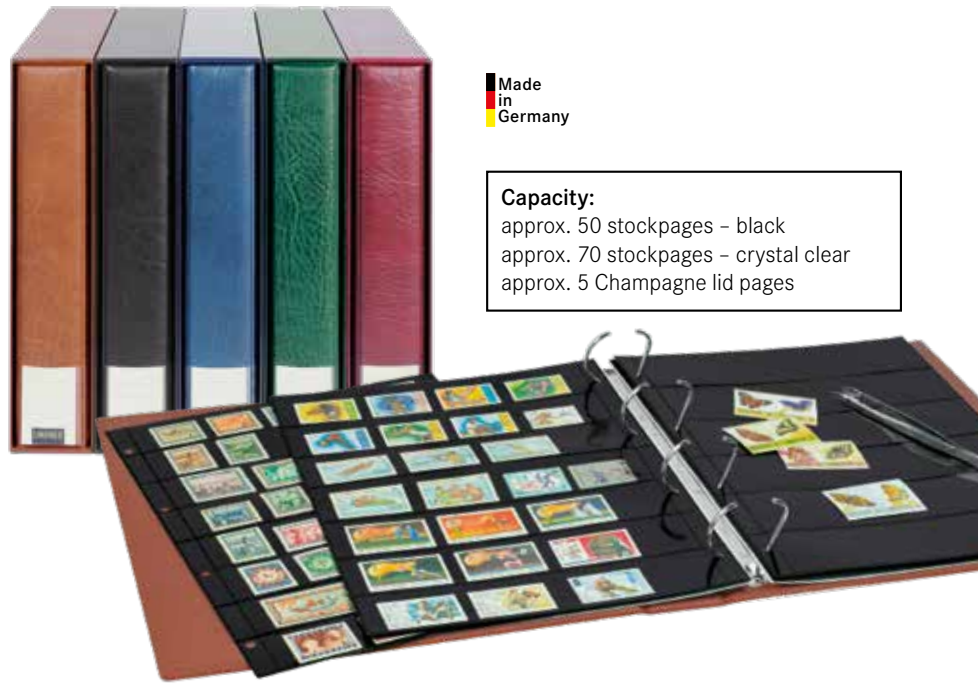

STOCKPAGES A4 FOR PUBLICA LS

Made in Germany



Pack of 10
● 4101
○ 8811



Pack of 10
● 4102
○ 8812



Pack of 10
● 4103
○ 8813



Pack of 10
● 4146
○ 8844



Pack of 10
● 4106



Pack of 10
● 4107



Pack of 10
● 4108



Pack of 10
○ 4066



Pack of 10
○ 8849



Pack of 10
○ 8846



Champagne lid pages
The lids are inserted from the back into the page. The front of the capsule is always protected.
Material: crystal-clear plastic
Format: 240 x 305 mm

Pack of 5
○ 3502

● **Black stockpages**
Black stockpages with crystal clear strips or pockets on both sides.
Material: Acid and softener-free hard-PVC-foil.
Format: 240 x 305 mm

○ **Crystal clear stockpages**
Interleaving black. One-sided crystal clear stockpages. Items can be viewed from front and back.
Material: Acid and softener-free hard-PVC-foil.
Format: 240 x 305 mm

○ **Crystal clear stockpages**
Material: softener-free PP-foil.
Format: 240 x 305 mm

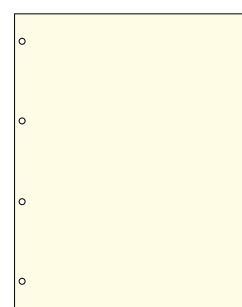

Pack of 10
● 8060

Blank pages
With 4-ring perforation, Size PUBLICA L: 235 x 298 mm.
Material: 200 g/qm

Made in Germany

ENVELOPES AND SLEEVES MADE OF GLASSINE

For ideal and safe protection of stamps, blocks, sheetlets, envelopes, FDC's, postcards, telephone cards, banknotes, photos and negatives. Glassine envelopes are made out of pure pine wood cellulose which is 100% recyclable. The glassine is transparent, anti-static, chlorine and acid free and does not contain chemical softeners.

Made in Germany



All measurements are internal measurements in mm.
Pack of 500

Special production on request.

- food safe
- tasteless and odorless
- breathable
- recyclable and compostable
- suitable for archives, because it is ph-neutral
- Paper thickness: 40g/m²

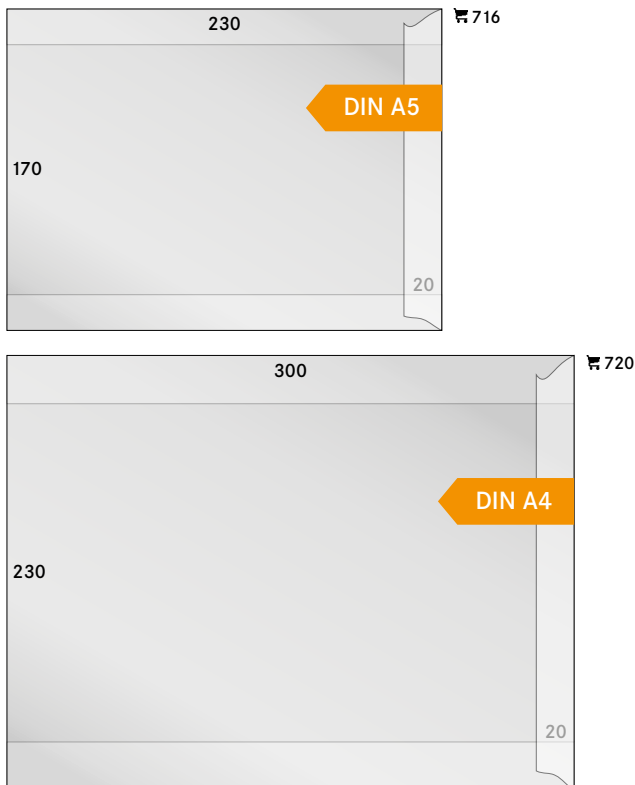
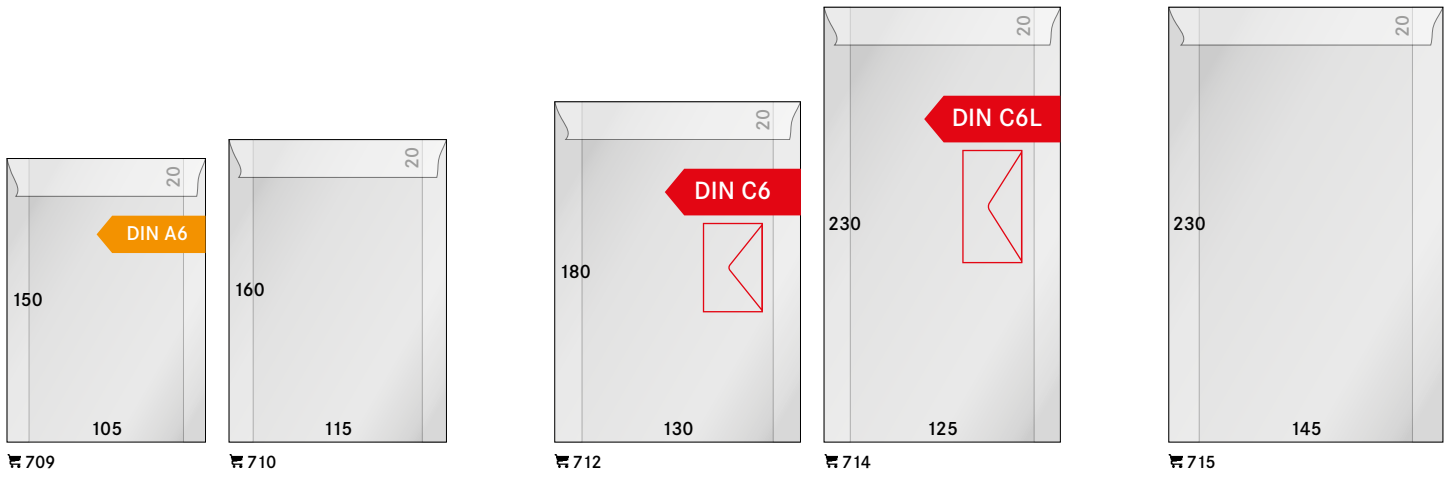

PERGAMIN SLEEVES

Pack of 100

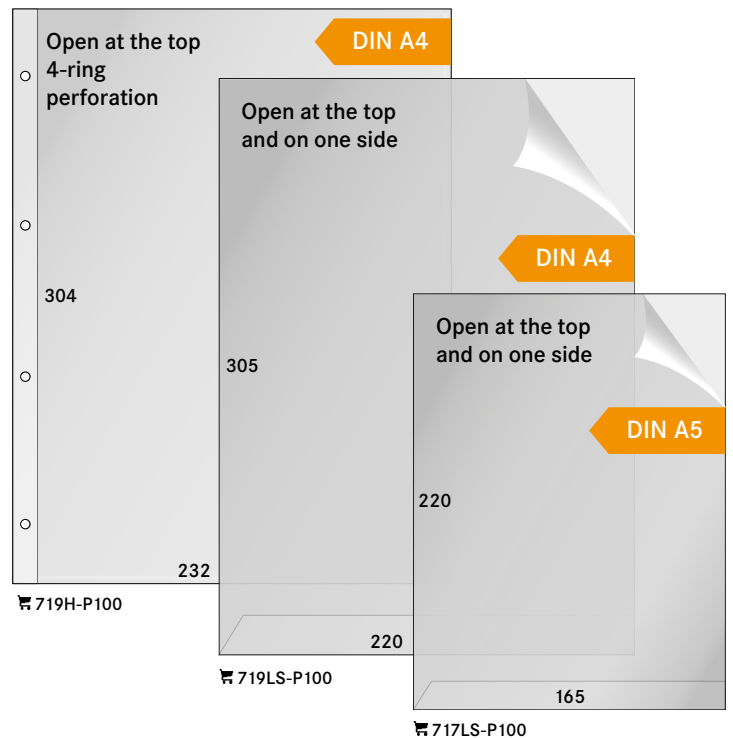

PROTECTIVE SLEEVES

FOR POSTCARDS, POSTAL HISTORY, BANKNOTES, PHOTOS, TELEPHONE AND BASEBALL CARDS ETC.

All protective sleeves are made from a crystal clear, acid and chemical softener-free synthetic-foil. Film thickness: 0.1 mm. All measurements are internal measurements in mm. The red line identifies the open side.

Special production on request.

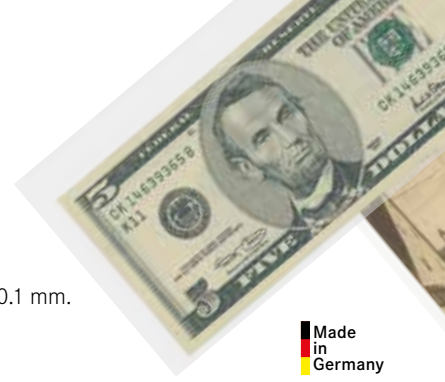

e.g. for Telephone cards
Pack of 50

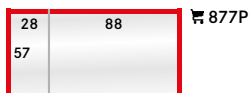

e.g. for Telephone cards with price labels
Pack of 50

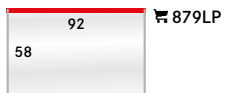

e.g. for Telephone cards
Pack of 50

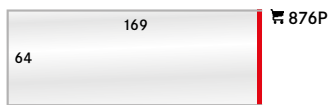

e.g. for Protective sleeve for K7E
Pack of 50

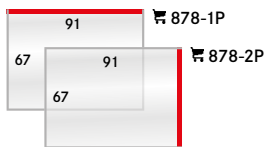

e.g. for Trading cards/
Baseball cards
Pack of 50



e.g. for Banknotes
Pack of 50

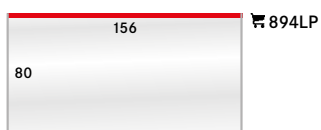

e.g. for Banknotes
Pack of 50

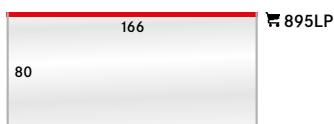

e.g. for Banknotes US-Dollar
Pack of 50

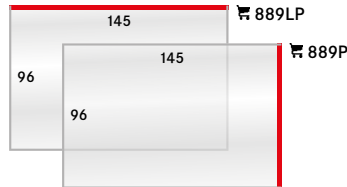

e.g. for old Postcards
Pack of 50

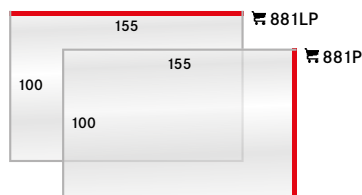

e.g. for modern Postcards
Pack of 50

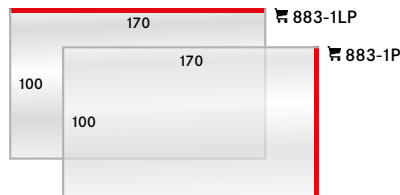

e.g. for FDC, Envelopes US size 6
Pack of 50



e.g. for FDC
Pack of 50

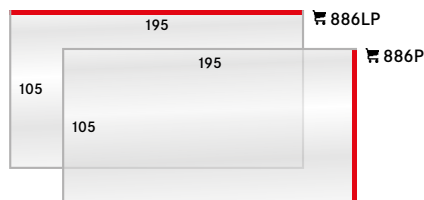

e.g. for European Envelopes long
Pack of 50

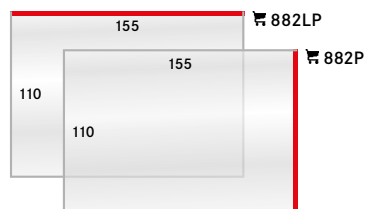

e.g. for modern Postcards,
small approval cards
Pack of 50

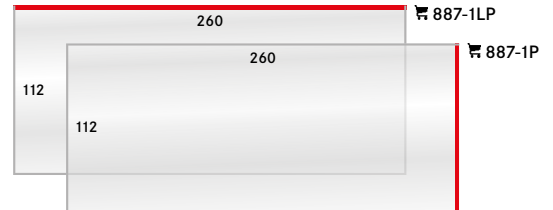

e.g. for Letters in long format,
US-Letters no. 10
Pack of 50

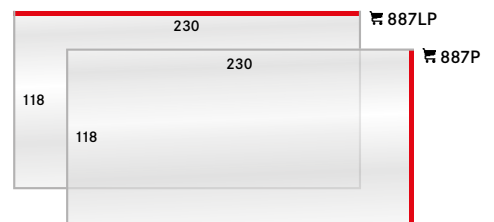

e.g. for Letters DIN C6 long
Pack of 50

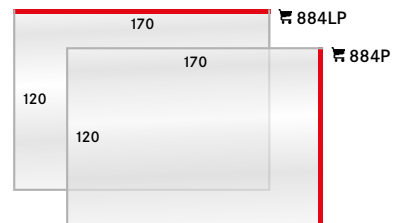

e.g. for European envelopes, DIN C6
Pack of 50

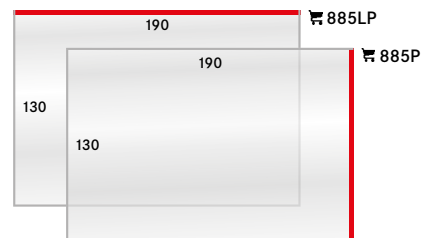

e.g. for larger envelopes
Pack of 50

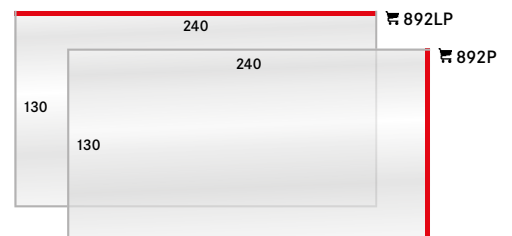

e.g. for Envelopes DIN C4, miniature sheets
Pack of 50



FREESTYLE PROTECTIVE SLEEVES

FOIL SHEETS OF OUR RENOWNED PROTECTIVE COVERS WITH SELF-ADHESIVE STRIP ON THE LEFT SIDE. FOR BANKNOTES, POSTCARDS, LETTERS ETC...

Using the self-adhesive strip, the covers can be mounted individually on each album page. In this way, the protective covers can be integrated into any conventional collection system.

All protective sleeves are made from a crystal clear, acid and chemical softener-free synthetic-foil. Film thickness: 0.1 mm. **All measurements are internal measurements in mm. The red line identifies the open side.**

Special production on request.

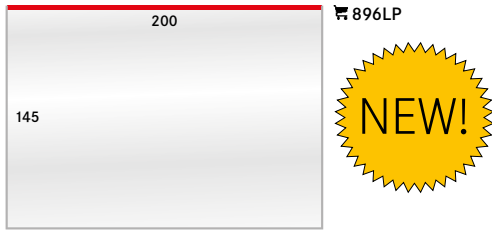

e.g. for DIN A5, ETB's
Pack of 50

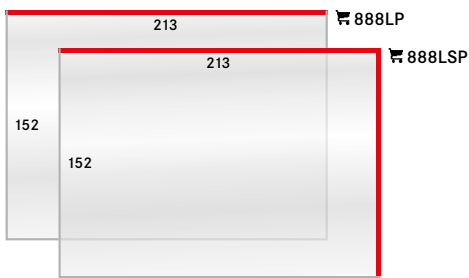

e.g. for DIN A5, ETB's
Pack of 50

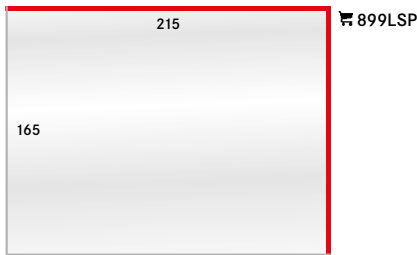

e.g. for DIN A5, ETB's
Pack of 50

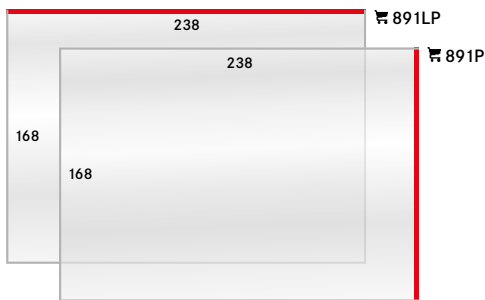

e.g. for large covers, miniature sheets
Pack of 50



e.g. for DIN A4
Pack of 50



e.g. for Banknotes
Pack of 25

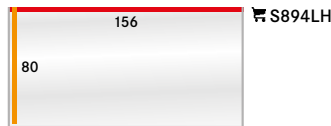

e.g. for Banknotes
Pack of 25

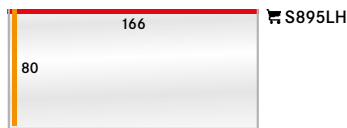

e.g. for Banknotes US-Dollar
Pack of 25

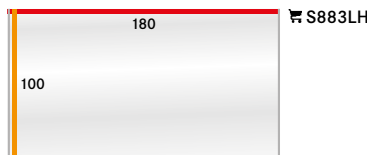

e.g. for FDC
Pack of 25

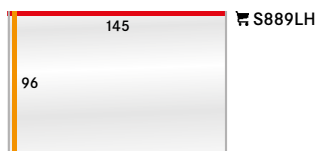

e.g. for old Postcards
Pack of 25

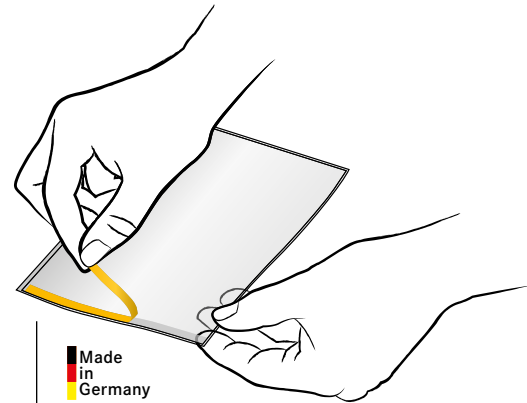

Made in Germany

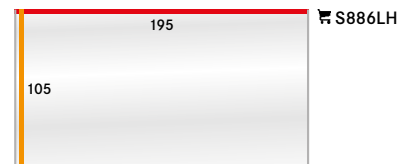

e.g. for European Envelopes long
Pack of 25



e.g. for modern Postcards, small approval cards
Pack of 25



e.g. for DIN A5, ETB's
Pack of 25

APPROVAL CARDS

PLASTIC APPROVAL CARDS MADE OF CARDBOARD WITH TRANSPARENT PROTECTIVE FLAP

Format: 158 x 113 mm, made of one-sided black cardboard (300 g/m²) with softener-free crystal clear foil strips and cover sheet. Strips open on the side. **Pack of 100**



With 3 strips, height: 18 mm
773
 (Pack of 100)



With 4 strips, height: 15 mm
774
 (Pack of 100)



Format: 210 x 148 mm, made of one-sided black cardboard (300 g/m²) with softener-free crystal clear foil strips and cover sheet. Strips open on the side. **Pack of 100**



With 5 strips, height: 14 mm
775
 (Pack of 100)



Fitting cases
 on page 19.

PLASTIC APPROVAL CARDS »EXTRA« MADE OF HARD-PVC

Format: 145 x 83 mm, made of hard-PVC which is 100 % free of any chemical softeners. Strips open on the side. **Pack of 100**

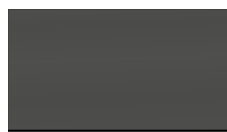

With one strip, height: 80 mm
751
 (Pack of 100)

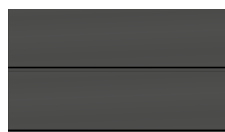

With two strips, height: 38 mm
752
 (Pack of 100)



Protective sleeves
Pack of 100

Protective sleeves, free of chemical softeners
 149 x 86 mm (Inner measurements) **758**

APPROVAL CARDS MADE OF HARD-PVC

Format: 210 x 143 mm, made of black hard-PVC-material (400 my) with welded, crystal clear strips (100 my), free of chemical softeners. Strips closed on the side. **Pack of 10**

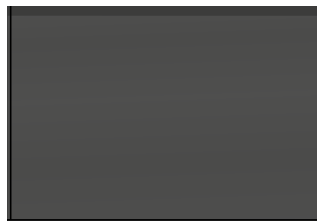

1 strip, height: 137 mm
771
 (Pack of 10)

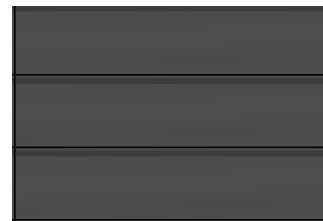

3 strips, height: 43 mm
773
 (Pack of 10)

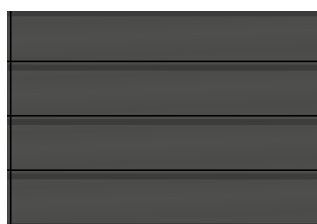

4 strips, height: 30 mm
774
 (Pack of 10)



5 strips, height: 24 mm
775
 (Pack of 10)



6 strips, height: 19 mm
776
 (Pack of 10)



Set of 6 index cards,
 white
777



APPROVAL CARD BOX

EMPTY

The practical approval card Box from LINDNER is made from a sturdy, black plastic and offers space for approximately 60 cards (Order no. 771-776). Appropriate for single stamps, sets, small blocks, postal cards, etc. Index cards help to keep everything organised.

Format: 220 x 165 x 65 mm

Suited for: Approval Cards A5

777 Approval card Box, empty

STAMP TONGS

"AN INDISPENSABLE TOOL"

Stamps are very delicate. Never touch stamps with your fingers! To avoid damage of any kind, it is of utmost importance to handle stamps only with good quality stamp tongs. They are an essential tool for every collector.

STAMP TONGS NICKEL-PLATED

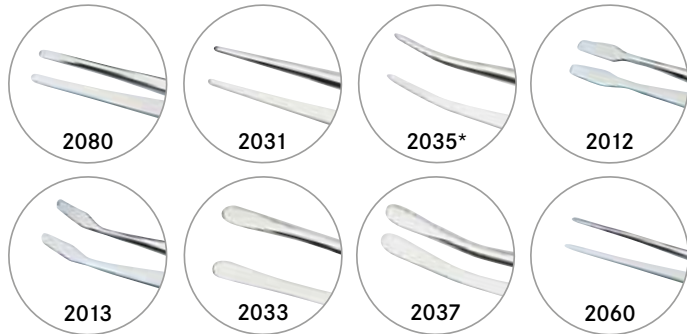

Stamp Tongs 120 mm, Nickel-plated

🛒 2080	long round tip, in a plastic sleeve
🛒 2031	straight, with pointed tip
🛒 2035*	bent, with pointed tip
🛒 2012	spade ends - straight, in a plastic sleeve
🛒 2013	spade ends - bent, in a plastic sleeve
🛒 2033	straight, with wide, round tip
🛒 2037	bent, with wide, round tip



Stamp Tongs 150 mm, Nickel-plated

🛒 2060	with pointed tip, in a plastic sleeve
--------	---------------------------------------

STAMP TONGS STAINLESS STEEL

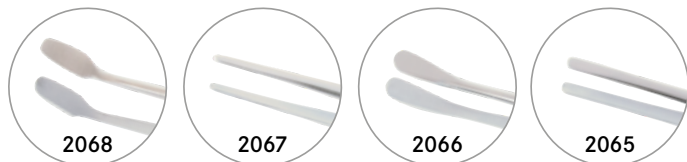

Stamp Tongs, stainless steel (in a plastic sleeve)

🛒 2068	150 mm, bent, with spade ends
🛒 2067	150 mm, straight, with pointed tip
🛒 2066	115 mm, bent, with spade ends
🛒 2065	115 mm, straight, with pointed tip

PHILA-COMBI-BOX, PERFORATION GAUGE

Precision perforation gauge from LINDNER for accurate readings! The perforation of the stamp is placed against the raised teeth of the gauge – it's fast, easy and precise! Especially practical: The lid of the box can be used as a tray to detect watermarks by using chemically safe watermark fluid.

Format: 115 x 55 mm

🛒 2099



LINDNER STAMPSCOP

The LINDNER Stampscop reveals watermarks, damage, repair and thin spots on stamps. The device works with the same principles as the Letter-scope, depending upon how the Stampscope is held up against the light. Instructions are enclosed!

🛒 9111



ERNI – STAMP CARE PRODUCTS

FOR PROFESSIONAL TREATMENTS OF STAMPS

It's all about retaining the value and perfection! ERNI products help the collector improve the value and condition of used stamps! The complete set provides all-round care for all kinds of different "problems".

Mildew Stain Remover ERNI A
Content: 200 ml
€ 8070

Mildew Stain Remover ERNI B
Content: 200 ml
€ 8071

ERNI Stamp Remover for self-adhesive Stamps
Removes self-adhesive stamps from covers, postcards etc.
Content: 200 ml
€ 8080

ERNI Stamp Gum Remover
Content: 200 ml
€ 8072

ERNI "Schon" Hinge Mark Remover
Content: 200 ml
€ 8073

LINDNER Stamp Remover
...removes stamps without water! Gum and existing numbers on the back of coil stamps will be retained if the product is applied from the back of the paper. Used properly, the stamp remover is absolutely safe.
Content: 100 ml
€ 8060

ERNI A and ERNI B must be used together.

Made in Germany



Trays, Pack of 2.
Format: 94 x 68 x 29 mm
€ 8076

Identification according to Regulation (EC) No. 1272/2008 Statements:

ERNI A (€ 8070)

Caution

H315 Causes skin irritation.
H319 Causes serious eye irritation.
H411 Toxic to aquatic life with long lasting effects.



ERNI B (€ 8071)

Caution

H290 Can be corrosive to metals.
H315 Causes skin irritation.
H319 Causes serious eye irritation.
H317 Can cause allergic reactions to your skin.
H351 Suspected of causing cancer.
H373 May cause damage to organs through prolonged or repeated exposure.



LINDNER Stamp Remover (€ 8060)

Danger

H318 Causes serious eye damage.



FLAG-STICKERS

These flag-stickers can be used for proper identification of a collection. They are self-adhesive and can be attached to the binder, or placed inside the plastic window on the spine of the LINDNER ring binders.

Pack of 6



Made in Germany

Deutsches Reich	€ 628	Guernsey	€ 661	Russia	€ 682
Germany	€ 630	Ireland	€ 664	San Marino	€ 649
West Berlin	€ 632	Iceland	€ 668	Sweden	€ 670
East Germany GDR	€ 634	Italy	€ 647	Switzerland	€ 646
Aland	€ 666	Jersey	€ 662	Slovakia	€ 676
Andorra	€ 665	Latvia	€ 653	Slovenia	€ 677
Bulgaria	€ 639	Lithuania	€ 659	Soviet Union	€ 681
Belgium	€ 635	Liechtenstein	€ 640	Spain	€ 638
Denmark	€ 641	Luxembourg	€ 654	Czech Republic	€ 678
Estonia	€ 645	Malta	€ 672	Ukraine	€ 683
Europe	€ 655	Isle of Man	€ 663	Hungary	€ 679
Faroe Islands	€ 642	Monaco	€ 650	Vatican	€ 648
Finland	€ 667	Netherlands	€ 637	United Nations	€ 656
France	€ 636	Norway	€ 669	Belarus	€ 684
Gibraltar	€ 651	Austria	€ 644	Canada	€ 658
Greece	€ 652	Poland	€ 673	Israel	€ 675
Greenland	€ 643	Portugal	€ 671	USA	€ 657
Great Britain	€ 660	Romania	€ 674	Cyprus	€ 680

PRICE LABELS

(Pack of 1000)



Format:
23 x 27 mm
€ 802024



Format:
25 x 30 mm
€ 802022



Format:
31 x 36 mm
€ 802023

Made in Germany

DRYING BOOKS

LINDNER drying books are the ideal tool for drying stamps that were removed from paper.

1 Drying Book, heavy laminated cover, spiral binding and 10 blotting sheets with safety interleaving for all gum types. Size: DIN A4
€ 845

2 Drying Book, plain, 10 pages. Size: DIN A4
€ 846

3 Drying Book, plain, 10 pages. Size: DIN A5
€ 847



Made in Germany

MINT SHEET ALBUMS

The albums are equipped with softener-free foil pockets and glassine interleaves. 100 sheets find place in each of the three albums. The albums are designed for different sheet sizes.

Format: 280 x 325 mm
Holds mint sheets up to size 245 x 315 mm
€ 860

Slipcase
€ 860K

Format: 280 x 385 mm
Holds mint sheets up to size 240 x 360 mm
€ 861

Slipcase
€ 861K

Format: 325 x 325 mm
Holds mint sheets up to size 290 x 315 mm
€ 862

Slipcase
€ 862K



Made in Germany

PAGE LIFTERS, SET OF 2

Prevents bending of the pages when closing the ring binder.
€ 799

Made in Germany



SLIPCASE PULL-HANDLE

For simple removing of the ring binders from the slipcase. Simply place the pull-handle into the bottom of the slipcase.
€ 798

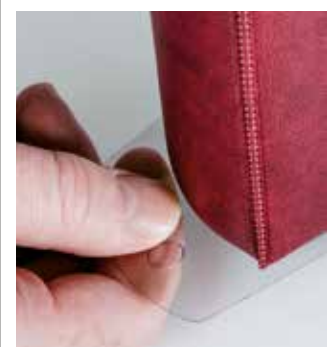

COLLECTION BOX

HEIGHT 40 mm – EXTRA SPACE FOR COLLECTORS SPECIAL WISHES!

Our collection boxes are so versatile. Many collectable items can be stored in any of the three different versions: minerals, decorations, medals, watches, jewellery, tin soldiers, pill boxes, valuable buttons and lighters, silver and gold items, precious vacation souvenirs and much more. The collection box comes in different lay-outs including movable dividers to adjust the individual compartments.

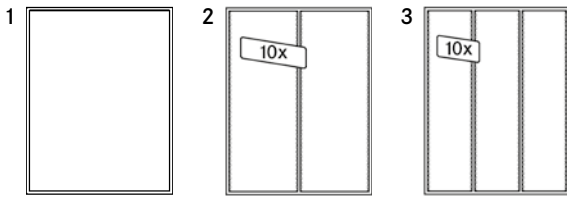

	COMPARTMENTS		Standard	Smoked glass
1	one large compartment	220 x 280 mm	2401	2461
2	with 2 compartments and 10 movable dividers	105 x 280 mm	2402	2462
3	with 3 compartments and 10 movable dividers	65 x 280 mm	2403	2463

Made in Germany

FITTING CASES ON PAGE 22.

ACCESSORIES

DIVIDERS, FOR COLLECTION BOX



Dividers, for collection box: long, red for collection box 2402, Pack of 10		2410
Dividers, for collection box: short, red for collection box 2403, Pack of 10		2411
Dividers, for collection box: long, dark red for collection box 2462, Pack of 10		2470
Dividers, for collection box: short, dark red for collection box 2463, Pack of 10		2471

Format: 236 x 303 x 40 mm
Max. filling height: 29 mm



Made in Germany



LINDNER coin boxes, d-boxes and collection boxes can be mixed and stacked on top of each other. Only the height of each box is different!

COLLECTION BOXES

FOR PINS / MEDALS / EMBLEMS

This collection box allows you to store your pins, medals, emblems, jewellery etc. in our famous LINDNER box systems, safely protected and always available for presenting your collections. The foam inserts with their velvet surface keep your collectibles safe at all times. As with all LINDNER coin boxes, d-boxes or collection boxes, you can choose between a drawer in light grey or high-quality smoked glass. The transparent frame protects the collectibles while at the same time allowing a perfect view of your items. For the perfect presentation of your collectibles, you can choose between different coloured inserts of light red, blue or black. The collection box can hold collectibles with a height of max. 15 mm.



Model			
Standard	2417	2419	2418
Smoked glass	2457	2459	2458

Format: 236 x 303 x 40 mm
Max. filling height: 15 mm



STACKABLE ASSORTMENT BOX WITH MOVABLE DIVIDERS

Easy to open by a convenient flap lid. With one fixed bridge. The two elongated compartments can be divided into 12 smaller compartments with the 10 dividers that are included. By means of 4 little feet and 4 corresponding slots in the cover the boxes can be easily stacked.

Format: 220 x 110 x 38 mm

Internal height: 33 mm

Made of transparent synthetic material with flexible compartments.

 **4820** Per piece
 **4820P** Pack of 10





STACKABLE ASSORTMENT BOX



Assortment box with hinged cover made from transparent synthetic material. Ideal for a collection of small items such as small figures, beads or fossils. The boxes are stackable and come in two different sizes.

Format: 190 x 99 x 22,5 mm

Assortment box with 6 fix compartments

 **4821** Per piece
 **4821P** Pack of 10

Assortment box with 12 fix compartments

 **4822** Per piece
 **4822P** Pack of 10



NIMBUS DISPLAY FRAMES

GIVE YOUR FAVOURITE COLLECTIBLES THAT "SPECIAL LOOK"

The display frames of the NIMBUS Series offer a completely new way of displaying your collectibles. The special feature of these frames are the two crystal clear, flexible silicone membranes which surround your items gently and create the impression that they are suspended inside the frame. At the same time you have an unlimited view of the back and front side of your favorite pieces. There is almost no limit of what kind of items you can

display in these frames. The material is very flexible and adapts completely to the surface of the objects and keeps them in place. From coins (in capsules) and stamps to writing utensils, watches, knives, decorations, photos, jewellery and other collectibles - with NIMBUS you can display your favourite objects in a special 3D frame!

Special production from 10.000 pieces.
Embossing possible from 100 pieces.



...HERE IS HOW IT WORKS:

Open the frame completely. Place the collectible on one of the two silicone membranes and close the frame. The object will be held in place by the surrounding silicone membranes, keeping it in its position. A magnetic closure holds the frame together!



NIMBUS 50
 Internal: 50 x 50 mm
 External: 80 x 85 x 35 mm
 ● 4828 black

NIMBUS 70
 Internal: 70 x 70 mm
 External: 100 x 105 x 35 mm
 ● 4830 black
 ○ 4850 white

NIMBUS 100
 Internal: 100 x 100 mm
 External: 130 x 135 x 35 mm
 ● 4839 black

NIMBUS 150
 Internal: 150 x 150 mm
 External: 180 x 185 x 35 mm
 ● 4838 black
 ● 4868* Crocodile look, red
 ● 4878* Wood tone, brown

*Delivery only while stocks last.

Delivery do not include contents / display material. All specifications are subject to change without prior notice.



NEMO

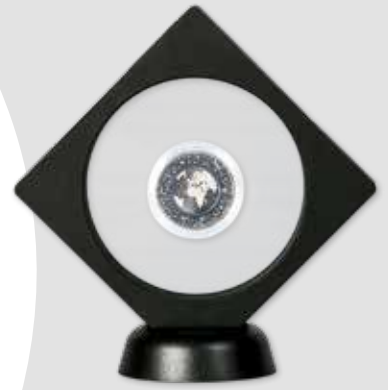

NIMBUS NEMO
with round cutout Ø 75 mm
External: 90 x 90 x 20 mm
Inner diameter: 75 mm
● 4833 black

ECO



NIMBUS ECO 70
Internal: 70 x 70 mm
External: 100 x 100 x 25 mm
● 4835-S black

NIMBUS ECO
Material: Synthetic.
With snap-lock.



NIMBUS ECO 100
Internal: 100 x 100 mm
External: 130 x 130 x 25 mm
● 4836-S black
○ 4836-WS white
● 4836-B blue

NIMBUS ECO 150
Internal: 150 x 150 mm
External: 180 x 180 x 25 mm
● 4837-S black



NIMBUS 230
Internal: 230 x 180 mm
External: 270 x 225 x 45 mm
● 4831 black
○ 4851 white



NIMBUS 265
Internal: 265 x 60 mm
External: 295 x 95 x 35 mm
● 4832 black
○ 4852 white

ALU SHOWCASE

Useful height: max 35 mm. The showcase has strong metal reinforced corners and two locks. The lid with window can be opened 90°. Wall mounting is possible upright or diagonally.



Storage showcase made of aluminium with transparent synthetic insert with 45 compartments
36 x 49 mm.
€ 4890-45



Storage showcase made of aluminium with transparent synthetic insert with 24 compartments
65 x 58 mm.
€ 4890-24



Storage showcase made of aluminium with transparent synthetic insert with 12 compartments
87 x 90 mm.
€ 4890-12



Storage showcase made of aluminium with transparent synthetic insert with 6 compartments
275 x 57 mm.
€ 4890-6



Format:
395 x 300 x 45 mm



EXPO - FLEXIBLE COLLECTION AND PRESENTATION SYSTEM

Versatile single modules made of stable acrylic glass with a folding front cover perfect to protect and display items including, model trucks, model cars, collectable toys, fossils, perfume miniatures.... and many other things.

Each single module has a standard bridge. Smaller objects can be presented on two levels. The standard bridge can be withdrawn allowing taller objects to be integrated into the display. With the help of the provided screws you can join

together several single modules in a simple and stable way making an attractive collection showcase while all individual modules remain accessible. The stable wall mount allows you to affix your collecting treasures safely onto a wall.

The wall mount can be connected with the single modules also with the help of the screws provided. However, screws to fix the wall mount onto the wall are not included in the delivery. **Format:** 400 x 100 x 60 mm



EXPO - Wall Mounter
€ 4811

EXPO - Single Module
€ 4810

EXPO - Set:
3 Single modules
+ 1 wall mounter
€ 4812



COLLECTION/PRESENTATION BOXES FOR SWISS POCKET KNIVES

Pocket knives are not only practical and helpful equipments for hobby, leisure and work. They are also popular and desired collectibles. We at LINDNER have also developed options to store and present these "treasures" in a representative and protected manner.

- Drawer in smoked glass finish
- Crystal clear frame made of scratch-resistant and robust synthetic material
- Perfectly fitting inserts made of high quality "BLACK SAMT"-foam
- Stackable

AVAILABLE IN FOUR VARIANTS:



LINDNER Collection-/Presentation box for 12 Swiss pocket knives VICTORINOX* model "Cadet", Length 84 mm (folded up) as well as for other models in same size and type.
Max. thickness of knife: approx. 27 mm
Format: 236 x 303 x 40 mm

€ 2476



LINDNER Collection-/Presentation box for 21 Swiss pocket knives VICTORINOX* model "Classic", Length 58 mm (folded up) as well as for other models in same size and type
Format: 236 x 303 x 30 mm

€ 2874



LINDNER Collection-/Presentation box for 12 Swiss pocket knives VICTORINOX* models "Pioneer" and "Farmer", Length 93 mm (folded up) as well as for other models in same size and type.
Max. thickness of knife: approx. 27 mm
Format: 236 x 303 x 40 mm

€ 2475



LINDNER Collection-/Presentation box for 12 Swiss pocket knives VICTORINOX* models "Huntsman", "Mountaineer", "Tinker", "Climber" and "Spartan", Length 91 mm (folded up) as well as for other models in same size and type. Max. thickness of knife: approx. 27 mm
Format: 236 x 303 x 40 mm

€ 2469

NIMBUS DISPLAY FRAMES FOR SWISS POCKET KNIVES

Give your favourite collectibles that "special look" Details as well as the complete assortment of NIMBUS-Frames can be found on pages 98-99.



FOR THE STORAGE OF CHAMPAGNE LIDS

CHAMPAGNE LID ALBUM

Ring binder made of padded synthetic-foil incl. 5 champagne lid pages made of a sturdy, crystal clear synthetic material. Every page offers space for 42 champagne lids. The lids are inserted from the back into the page. The front of the capsule is protected all the time.

Format: 290 x 315 x 60 mm

Mechanism: 4-ring , 80/80/80 mm

Scope of Delivery:

Ring binder, 5 Champagne lid pages.



3503CH-S



3504-S



Made in Germany



Other products suitable for this ring binder can be found on pages 88.

CHAMPAGNE LID PAGES, PACK OF 5

Suited for 42 champagne lids each.

3502



S3505*

CHAMPAGNE LID ALBUM - SPECIAL EDITION

Ring binder made of synthetic-foil incl. 5 champagne lid pages made of a sturdy, crystal clear synthetic material. Every page offers space for 42 champagne lids. The lids are inserted from the back into the page. The front of the capsule is protected all the time.

Format: 290 x 315 x 55 mm

Mechanism: 4-ring , 80/80/80 mm

Scope of Delivery:

Ring binder, 5 Champagne lid pages



Other products suitable for this ring binder can be found on pages 88.

NERA M

NERA Case M for 48 Champagne lids.
(see page 26)



- 2364-2148E
- 2364-2748E
- 2364-2148ME
- 2364-2148CE

NERA CASE M PLUS - WITH WINDOW

NERA Case M PLUS - with window for 48 Champagne lids.
(see page 26)



- 2367-2148E
- 2367-2748E
- 2367-2148ME
- 2367-2148CE

NERA XL

NERA Case XL for 144 Champagne lids.
(see page 27)



- 2365-2148E
- 2365-2748E
- 2365-2148ME
- 2365-2148CE

CARUS-1

Solid Wood Case CARUS 1 for 48 Champagne lids.
(see page 28)



Made in Germany

- S2491-2748E
- S2491-2148ME

CARUS-4

Solid Wood Case CARUS-4 for 192 Champagne lids.
(see page 29)



Made in Germany

- 2494-6
- 2494-6M

SOLID WOOD COIN CASE

Solid Wood Coin Case for 240 Champagne lids.
(see page 30)



Made in Germany

- S2495-S2148CE
- S2495-S2148ME

CHAMPAGNE LID BOX

(see page 8)



Made in Germany

- 2148F
- 2748F

COIN CASE ALU

Coin case ALU incl. 5 trays for 240 Champagne lids.



- S2307-CHM
- S2307-CHC

INSERT TRAY "ECO LUXE"

Insert tray with transparent lid for 40 Champagne lids.

Format: 298 x 205 x 10 mm
Pack of 2

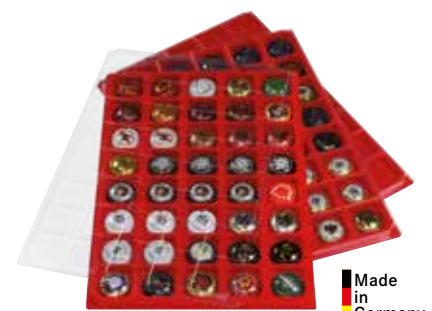

Made in Germany

- 3510P

ACCESSORIES FOR "JETONS TOURISTIQUES"



MATCHING COIN CAPSULES

Coin capsules 34,5 mm (Interior Ø)

Pack of 10

☒ 2250345P

Pack of 100

☒ 2251345



COIN BOX FOR 24 "JETONS TOURISTIQUES" IN CAPSULES

(see page 6)

Made in Germany



● 2224
● 2624

KARAT COIN ALBUM FOR "JETONS TOURISTIQUES"

High-quality, ring binder made of padded synthetic foil. Comes with 5 karat-coin pages (Order no. K2) and 5 white interleaves.

Pack of 5 karat-coin pages
Paper interleaves, white, neutral.

☒ K2W

Format Ring binder: 210 x 230 x 30 mm

Mechanism: 4-ring, 45/65/45 mm

Capacity:

10 karat-coin pages K2

(for a total of 120 "Jetons Touristiques")

☒ 1106JT



Karat

Other karat-pages
see page 32.

Made in Germany

COIN BOX FOR 30 "JETONS TOURISTIQUES"

(see page 4)

Made in Germany



● 2150
● 2750

NERA XL

NERA Case XL for 72 "Jetons Touristiques" in capsules (delivery without capsules). (see page 27)



● 2365-2224E
● 2365-2624E

NERA M

NERA Case M for 24 "Jetons Touristiques" in capsules (delivery without capsules). (see page 26)



● 2364-2224E
● 2364-2624E

COIN BOX FOR 30 "JETONS TOURISTIQUES"

(see page 4)

Made in Germany



● 2150
● 2750

NERA XL

NERA Case XL for 90 "Jetons Touristiques". (see page 27)



● 2365-2150E
● 2365-2750E

NERA M

NERA Case M for 30 "Jetons Touristiques". (see page 26)



● 2364-2150E
● 2364-2750E

LED TABLE LAMP ELUMENTIS

As a high-quality and powerful table lamp, elumentis LED features an perfect configuration that provides you with excellent illumination for various activities. It is flexible, user-friendly, has high light quality and customizable settings. Elumentis LED is perfectly suited for use in leisure, office, or workshop settings. It is also an ideal complement to magnifying visual aids for individuals with reduced vision, enhancing their ability to see.

- unadulterated, natural, and high-contrast colour reproduction with a very high colour rendering index Ra > 92
- Three colour temperatures: warm white (2700 K), neutral white (4800 K), daylight white (6400 K).
- 5 brightness levels, adjustable continuously or incrementally
- Uniform, glare-free illumination of the work surface
- An additional ambient light integrated in the luminaire head
- Intuitive operation via clearly arranged, tactile, and clearly defined buttons (no confusing multiple functions assigned to buttons)
- Luminaire head can be tilted 90° horizontally and 45° vertically
- Flat foldable, easy to store, portable
- Cable length: 2,50 m

Format: 300 x 130 x 530 mm

Weight: 1,8 kg

☛ E16039

LED LIGHT PAD

Handy and portable LED Light Pad for testing e.g. stamps and banknotes on damage, watermarks and security features. The LED technology ensures one uniform light distribution over the whole light field. Delivery without batteries (requires 6x AAA), including bag for storage.

Format: 155 x 150 x 14 mm
(Illuminated field: 125 x 100 mm)

☛ S10311

SET: LED Light Pad
including power supply

☛ S10311-SET



Delivery do not include contents / display material. All specifications are subject to change without prior notice.



ESCHENBACH

NEW!

LED TABLE LAMP ECONOMY VISION

Colour temperature and illuminance can be adjusted according to individual preferences. Can be used «to go» with a 5V power bank (not included in the delivery).

- Three colour temperatures: warm white (3000 K), yellow white (4000 K), blue white (5000 K)
- Flat foldable, easy to store, compact, portable.

Format: 330 mm (max. height)

☛ E16036

LED TABLE LAMP

This elegant table lamp offers the ideal lighting solution for various situations. Whether in the office, reading, background lighting - with 3 different colours this LED table lamp offers 5 levels of brightness. With 2 joints at the base and the head of the lamp, the height and the lighting angle can be adjusted. The head of the lamp is swivel-mounted. The integrated USB port allows you to charge your mobile devices. Due to the energy-saving LED technology the lamp is very eco-friendly. The lamp can be folded flat saving space.

- Height at horizontal head of lamp. 415 mm
- Max. light >1000 lux at 30 cm distance
- 500 lumen
- Sturdy-lamp foot of metal (185 x 125 mm with protective soft strips underneath)
- Colour temperature 3000-6000 kelvin

Format: 400 x 125 x 45 mm (folded)

☛ 7140



DIGIMICROSCOPE FLEX

The DigiMicroscope Flex impresses with its versatility. It can be used as a handheld microscope or on the enclosed flexible stand with suction cup. Thus it can be placed in any conceivable position. Objects and surfaces can be viewed directly on the PC, tablet or Smartphone. Photos can be taken separately or in programmable intervals. There is also the possibility to record videos.

☛ S66144

Technical data:

Resolution: 1600 x 1200 pixel (UXGA)
 Video resolution: 640 x 480 pixel (VGA)
 Magnifications: 60x, 250x
 Picture format: JPEG (picture)
 Video format: AVI (video)
 Lighting: 4 dimmable LEDs
 System Requirements:
 Windows: XP, Vista, 7, 8, 10 (32&64bit);
 Mac OS X: 10.5.6 and higher,
 Android 4.3 and higher.
 Connection/Power supply: USB 2.0 /
 USB-OTG

Scope of delivery: Flexible tripod with suction cups, with grid, software-CD, manual



Usable without computer!

DIGITAL MAGNIFIER

This digital magnifier offers a wide range of applications. With the freeze button you can freeze the image section of your choice, to be able to look at it static. With the integrated camera function, snapshots can be taken and saved on Micro SD (not included) and can be transmitted via USB cable to the computer. The stand can be folded out. There are 3 different color modes available. addition (full color, black on white and white on black).

Format: 135 x 80 x 35 mm

☛ S66143

Technical data:

Resolution: 640 x 480 pixels
 Magnification: 5x, 6x, 7.5x and 10x
 LCD display: 3.5 inch format 4:3
 Lighting: 4 LEDs
 Power supply/connections:
 USB 1.1, microSD card slot

Scope of delivery: digital magnifying glass, USB cable, operating instructions, cloth bag, cleaning cloth

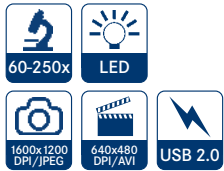
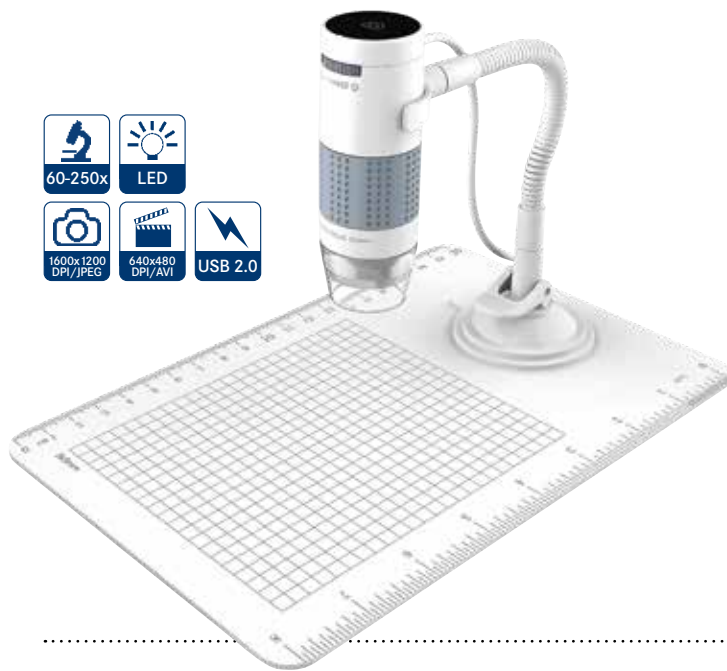

DIGIMICROSCOPE PROFESSIONAL

With the reflecta DigiMicroscope Professional, you can view objects or capture images and videos onto a microSD memory card. The integrated LCD display and the built-in Li-ion battery make the microscope a portable research lab. The device with AV-out offers the most versatile use, e.g. measuring and investigating the tiniest objects or surfaces.

Format: 230 x 150 x 110 mm

☛ S66134

Technical data:

Resolution: 5.0 megapixels (12 megapixels interpolated)
 Video resolution: VGA, QVGA
 Magnification: 20x-200x (optical), up to 500x (digital)
 Image format: JPEG, BMP
 Video format: AVI
 LCD display: 3.5 inch format 4:3
 Lighting: 8 LEDs
 System requirements: Windows, XP, Vista, 7, 8, 10 / Mac 10.6 - 10.13
 Power supply: Li-ion battery 3.7 V/800 mA or adapter (battery operating time: 2 hours battery charging time: 4 hours)
 Connections: USB 2.0, microSD card slot, AV output

Scope of delivery: digital microscope, adapter, Li-ion battery, USB cable, TV cable, user manual, software CD, cleaning cloth



Usable without computer!

UV TEST LAMPS

Banknotes, stamps, telephone cards and other documents are easily detected with a UV lamp. The UV lamp will show whether a stamp has been printed on normal paper or fluorescent paper. Fluorescent paper gives off a light

yellow or white glow compared to normal paper. Repairs and other defects can also be seen. The lamp will operate in daylight or artificial light.

MULTIFUNCTIONAL TESTER

FOR BANKNOTES, STAMPS, CREDIT CARDS, CHECKS ETC.

Fluorescence detection by UV-light and watermark detection by white light from bottom plate, incl. measuring scale. Magnetic sensor with optical and acoustic signal to detect magnetic security features. Window in the lid with magnifying glass 50,5 x 35 mm. Power supply via USB (USB charging cable included).

Format: 200 x 105 x 105 mm

€ S7085



UV-LAMP (long-wave)

For fluorescence detection / 365 nm. With flashlight function and fold-out stand. Without batteries. 4x AA are required.

Format: 160 x 55 x 25 mm

€ 7081



UV-LAMP (short-wave)

For fluorescence detection / 254 nm. With flashlight function and fold-out stand. Without batteries. 4x AA are required.

Format 165 x 58 x 25 mm € 7084

Replacement Tube, for Order no. 7084/7082. € 7081001



Phosphor lamp

LED MINI MICROSCOPE

The handy size of the LED Mini Microscope makes it readily available. With this Microscope you can view and check pressure grids, small embossing etc. very well. Just place it directly on the object, turn on the light and see the detail with 50x magnification.

Technical Data:

Magnification: 50x
Integrated optical zoom: No
Format: 100 mm
Delivery incl. batteries..

€ 7115



Usable
without
computer!



UV- FLASHLIGHT

UV- Flashlight with 9 UV-LEDs:

For fluorescence detection and testing of e.g. Banknotes, Stamps and for identification of everything that is only visible under UV-light.

Without batteries. 3x AAA are required.

Length: approx. 85 mm

€ S7189



MAGNIFIERS

UV/LED Magnifier with rechargeable battery

For checking banknotes, ID cards and other documents. Extremely handy and hands-free magnifying glass with bright LED light and UV light. The USB charging function makes it easy to charge the battery and saves you the hassle of changing batteries.

Scope of Delivery: UV/LED magnifying glass, transport case, cleaning cloth, 2 measuring scales, USB charging cable.

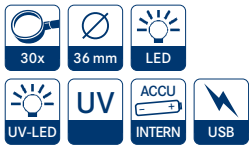

Technical data:

Double lens with 30x magnification and 2 interchangeable measuring scales. 2 LED modes (LED and UV), incl. transport case, cleaning cloth, USB charging cable. Magnifying glass dimensions: 55 x 55 mm.

€ S7192

UV detector pocket LED-magnifier rechargeable

With the UV LED-Detector pocket magnifier you can easily check banknotes, ID cards and other documents for counterfeiting. Very handy magnifying glass with bright LED light and 10x magnification. UV light (365nm) for checking documents. No annoying replacement of batteries. The USB charging allows easy charging of the detector.

Scope of Delivery: UV detector magnifier, Case, cleaning cloth, USB cable.

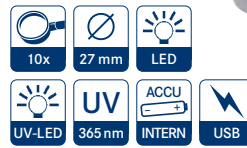

Technical data:

Distortion-free double lens made of glass with 10x magnification + integrated measurement scale. Sturdy aluminium housing. Rechargeable lithium-ion battery (via micro USB adapter). Charging time: about 1h. 2 LED modes: white lights (approx. 1,5 h). UV light (approx. 1 h), UV wave length: 365nm. Small and handy, magnifying glass: 45 x 42 mm, weight: 70 g.

€ S7191



LED Magnifier

Magnification: 5x, Diameter of the lens: 65/90 x 50 mm. Simply touch the silver ring of the magnifier to turn the LED-light on/off. Supplied with a padded black case, batteries are included.

€ 7193



LED Magnifier

Magnification: 5x, Format: approx. 100 x 100 mm, octagonal (view diameter 76 mm Ø). LED Magnifier in an aluminium design, with white LED lighting (4x), Supplied with a padded black case, batteries are included.

€ 7192



Folding Magnifier

Magnification: 10x, Diameter of the lens: 21 mm.

€ 2092



Folding Magnifier with LED lighting

Magnification: 10x, Diameter of the lens: 25 mm.

€ 2091



Stand Magnifier

Magnification: 10x, Diameter of the lens: 25 mm.

€ S66

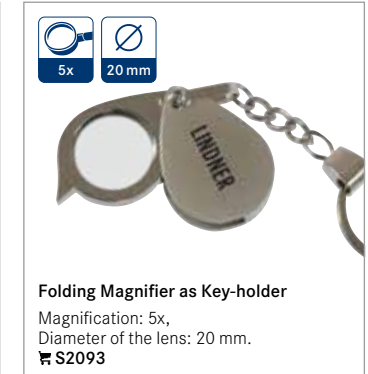

Folding Magnifier as Key-holder

Magnification: 5x, Diameter of the lens: 20 mm.

€ S2093



Rimless Standing Clamp Magnifier with LED Illumination

Magnification: 2,5x / 5x (Incorporated lense 5x magnification), Diameter of the lens: 87 mm.
 A very versatile standing clamp magnifier with a flexible metal stem and illuminated lens (2 LEDs can be switched on at the foot/base). Anti-slip aluminium clamp for work surfaces up to 38 mm thickness, with foldable chromed feet.
 Incl. batteries and lens cleaning cloth.
7154

Rimless Standing Magnifier with LED Illumination

Magnification: 2x / 6x (Incorporated lens 6x), Diameter of the lens: 90 mm.
 Flexarm: approx. 170 mm, Feet: approx. 190 x 165 mm.
 Incl. batteries.
S7150



Aluminium LED Magnifier

Magnification: 10x, Diameter of the lens: 30 mm.
 LED Magnifier in an aluminium design, viewing pane with a scale of 20 x 20 mm.
 Supplied in a padded case, without batteries.
7153



Rimless, aspheric LED Magnifier

Magnification: 3x / 5x, Diameter of the lens: 90 mm.
 The high-quality aspheric lens provides a clear picture without the typical distortion.
 Adjustable LED.
 Without batteries.
7114



Illuminated LED Magnifier

Magnification: 2,5x, Diameter of the lens: 55 mm.
 Illuminated Aluminium Magnifier with 8 white LEDs. Lens made of optic glass.
 Illumination adjustable in two settings (4/8 LEDs).
 Supplied in a padded case, without batteries.
7151



Rimless LED Illuminated Magnifier

Magnification: 8x / 20x (Incorporated lens with 20x magnification), Diameter of the lens: 90 mm.
 Incl. lens protective bag, without batteries.
S7132

Rimless LED Illuminated Magnifier
 Magnification: 2,5x / 4x (Incorporated lens with 4x magnification), Diameter of the lens: 110 mm.
 Incl. lens protective bag, without batteries.
 € S7131

Magnification: 3x / 4,5x, (Incorporated lens with 4,5x magnification), Diameter of the lens: 90 mm.
 Incl. lens protective bag, without batteries.
 € S7130

Rimless Handle Magnifier
 Magnification: 2x, Diameter of the lens: 90 mm.
 Incl. lens protective bag. € 7195

Magnification: 3x, Diameter of the lens: 75 mm.
 Incl. lens protective bag. € 7196

Metal Linen Tester with LED
 Magnification: 10x,
 Diameter of the lens: 27 mm.
 Robust metal linen tester with lighting and scale 25 x 25 mm. Incl. batteries.
 € S30

Metal Linen Tester
 Grossissement: 8x
 Diameter of the lens: 30 mm,
 With scale, field of view 25 x 25 mm.
 € S38

Multipurpose-LED Magnifier
 Magnification: 3x / 10x / 55x (Microscope 55x with light),
 Format: 115 x 40 x 25 mm.
 LED Magnifier incl. flashlight with 3 white LEDs. 1 white LED for the magnifier.
 With integrated UV-lamp.
 Incl. batteries.
 € S7159-S

LED Pocket Illuminated Magnifier
 Magnification: 2,5x, Format: 60 x 32 mm (closed).
 By pushing out the lens the LED illumination of the LED is automatically activated.
 Incl. batteries.
 € S7134

Rimless LED Illuminated Magnifier
 Magnification: 2x,
 Diameter of the lens: 90 mm.
 Incl. lens protective bag made of grey velour, batteries included.
 € 7152

LED Illuminated Magnifier, blue
 Magnification: 5x,
 Diameter of the lens: 50 mm.
 Incl. batteries.
 € S198-B

Cleaning Cloth for Magnifiers, Telephone Cards and Glasses
 The cleaning cloth made from HiTec-Microfibre is free of chemical additives, has a long shelf life and can be washed. Material 70 % Polyester and 30 % Nylon-Microfibre.
 Format: approx. 180 x 140 mm.
 € 8079

ESCHENBACH



Made in Germany

1.8x 65 mm

ESCHENBACH Bright Field Magnifier
Magnification: 1,8x, Diameter of the lens: 65 mm. Bright field magnifiers intensify and gather available light, thus brightening the viewing area. A magnification is possible if the distance between eye and magnifier is adjusted. This visual aid fits in every pocket! Glass magnifier with matte edge.

€ 7180

ESCHENBACH

Made in Germany



4x LED incl. 1x 2025

ESCHENBACH Compact Pocket Magnifier with LED light
Magnification: 4x, Format: 86 x 54 mm. easyPocket – up close and detailed! This handy magnifier can be taken anywhere.

€ 7184

ESCHENBACH

Made in Germany

NEW!



E1520910

10x 35 mm LED incl. 1x 2032

ESCHENBACH Technical folding Magnifier mobilent
Magnification: 10x, Diameter of the lens: 35 mm. The ideal magnifier for handbag and trouser pocket or for wearing around the neck. With neck cord.

€ E1710910

ESCHENBACH Technical folding Magnifier mobilent LED
Magnification: 10x, Diameter of the lens: 35 mm. The ideal illuminated magnifier for when you're on the move: high-magnification, small and handy; suitable for wearing around the neck, for use as a hand-held magnifier and fits in a trouser pocket. With neck cord.

€ E1520910

ESCHENBACH

Made in Germany



ESCHENBACH Linen Tester
Precision quality linen tester, brass casing, silky-matte, chrome-plated finish. Lens: Biconvex, optically ground silicate glass.

Magnification: 12x, Field of view 10 x 10 mm, 12,6 mm lens, height 23 mm.

€ 7175

Magnification: 10x, Field of view 15 x 15 mm, 14,6 mm lens, height 27 mm.

€ 7176

Magnification: 8x, Field of view 20 x 20 mm, 17,6 mm lens, height 33 mm.

€ 7177

ESCHENBACH

Made in Germany



ESCHENBACH Plastic Linen Tester
Linen tester in 3 sizes with imprinted scale on the side of the stand.

Magnification: 10x, Field of view 15 x 15 mm, Lens Ø 12 mm, height 28 mm.

€ 7197

Magnification: 8x, Field of view 20 x 20 mm, Lens Ø 16 mm, height 35 mm.

€ 7198

Magnification: 5x, Field of view 30 x 30 mm, Lens Ø 28 mm, height 53 mm.

€ 7199

ESCHENBACH

Made in Germany



2x

ESCHENBACH Magnifying Glasses MaxDetail
Precise viewing of collectibles while keeping your hands free. 2x magnification, weighing 49 g. Field of vision: 130 mm/400 mm, working area approx. 400 mm. Diopter compensation ± 3.0 dpt, adjustable on the right and left. Comes with a convenient case.

€ 7169

ESCHENBACH

Made in Germany



ESCHENBACH Approved, technical folding Magnifier
Approved, technical folding magnifiers. Matte, chrome-plated brass casing with loop, black metal lens frame and precision cut glass.

Magnification: 10x, Diameter of the lens: 21 mm.

€ 7170 Aplanat

Magnification: 12x, Diameter of the lens: 15 mm.

€ 7179 Aplanat

Magnification: 20x, Diameter of the lens: 17 mm.

€ 7172 Achromat

ESCHENBACH

Made in Germany



ESCHENBACH Stand Magnifier
Magnification: 8x, Diameter of the lens: 25 mm. Material: plastic. Lens: aplanatic PXM® – lightweight, distortion-free lens with cera-tec protective coating.

€ 7166

ESCHENBACH Magnifier
Magnification: 15x, Diameter of the lens: 15 mm. Material: with air vent to resist condensation. PXM® lens, 2 lenses.

€ 7167

ESCHENBACH



Magnification: 5x, Diameter of the lens: 58 mm. Incl. batteries

€ 7121

5x LED incl. 2x AA

7122 7123

7x 12,5x LED incl. 2x AA

Magnification: 7x, Diameter of the lens: 35 mm. Incl. batteries

€ 7122

Magnification: 12,5x, Diameter of the lens: 35 mm. Incl. batteries

€ 7123

Magnification: 4x, Format: 75 x 50 mm (rectangular lens). Incl. batteries

€ 7126

4x LED incl. 2x AA

ESCHENBACH Illuminated Pocket Magnifiers Mobilux with LED
Aspheric PXM®-light weight lens, hard-coated on both sides with cera-tec.

Made in Germany

ADVANTAGE OFFER

LINDNER T-ILLUSTRATED PAGES + RING BINDER SET REGULAR AT A SPECIAL PRICE!

TAKE ADVANTAGE OF THIS COMPLETE OFFER!

When purchasing a LINDNER T-illustrated set of pages, which is marked with "☺" on the following pages, we can offer you the possibility to buy the ring binder set REGULAR at a price saving.

The popular ring binder set REGULAR is available in the colours winered, tan, blue, black and green. Details for the ring binder set Regular are found on page 72.

GET THE BEST DEAL:

Select illustrated album with ☺, choose the colour of the ring binder set (Order no. 1124V) of your choice - and include both order numbers when placing your order. This will result in a price advantage compared to the purchase of the pages and ring binder set normally.

Ring binder and slipcase



1124V - G
1124V - S
1124V - B
1124V - H
1124V - W

Order no. LINDNER T-Illustrated Country Albums

Order this offer and **SAVE!**



INFORMATION FOR THE LINDNER ILLUSTRATED COUNTRY PAGES AND SUPPLEMENTS

ILLUSTRATED PAGES

Illustrated pages provide a full and complete overview of each country's issued stamps. LINDNER uses an acid-free, age resistant, and archival paper called "PERMAPHIL®"; the size is 272 x 296 mm. The firm, wood-free paper has an 18-hole perforation to fit all the original LINDNER 18-ring binders shown on pages 72-73.

Some of the illustrated albums are available in colour. These are marked in the following tables.

SUPPLEMENTS

Listed from page 124 are the yearly supplements for all LINDNER-T illustrated country albums. They are published in the early summer of each year and contain the supplement pages for all stamps issued in the previous calendar year. Stamp collections can be kept up-to-date and the continuous quality of the supplements guarantee a perfect match to the pages previously purchased.

NUMBER OF PAGES

In the following index, the number of pages is the actual amount of illustrated album pages in one set (title pages excluded). However, all sets contain title pages and are included in the price.

LINDNER SINGLE PAGE INDEX

The page index lists the year as well as the MICHEL numbers and/or the catalog numbers for each illustrated page. The LINDNER-T page indexes starting in January 2000 can be found on the internet under www.lindner-original.de/en in the section "Flyers & Brochures". For each area of interest you can obtain the retrospective years on request.

IMPORTANT:

The following tables contain the supplement pages 2022. The supplements for 2023 will be issued in spring 2024.

SINGLE PAGES

Every LINDNER-T illustrated album page can be purchased individually. Please provide exact order information including album number, page number and year since single pages can not be exchanged or returned. Example: 1 x 120b-49 pages 15, 16, 17 year 1959. We recommend before purchasing a large amount of single pages, check if it is less expensive to obtain a complete set instead of individual years. Please contact us if you need assistance.

Country	in colour	Period	Number of Pages	
ABU DHABI				
		1964 - 1972	7	167
ÅLAND ISLANDS				
		1984 - 2015	48 ☺	129A
	●	2016 - 2022	16	129A-16
ALDERNEY				
		1983 - 2011	48 ☺	145GA
		2012 - 2022	44 ☺	145GA-12
ANDORRA				
Spanish		1928 - 2015	51 ☺	123
	●	2016 - 2022	19	123-16
French		1931 - 1971	23	124
		1972 - 2007	47 ☺	124A
		2008 - 2022	32 ☺	124A-08
ARGENTINA				
		1858 - 1951	38 ☺	460-58
		1952 - 1969	39 ☺	461-52
		1970 - 1977	27 ☺	461
		1978 - 1984	44 ☺	461-78
		1985 - 1991	51 ☺	461-85
		1992 - 1998	41 ☺	461-92
		1999 - 2003	43 ☺	461-99
		2004 - 2007	37 ☺	461-04
ARMENIA				
		1992 - 2002	28 ☺	255
ARUBA				
		1986 - 2010	52 ☺	431
		2011 - 2022	45 ☺	431-11
AUSTRALIA				
		1913 - 1965	25 ☺	470
		1966 - 1982	38 ☺	470-66
		1983 - 1991	43 ☺	470-83
		1992 - 1997	42 ☺	470-92
		1998 - 2003	48 ☺	470-98
		2004 - 2006	47 ☺	470-04
		2007 - 2009	47 ☺	470-07
		2010 - 2012	53 ☺	470-10
		2013 - 2014	38 ☺	470-13
		2015 - 2016	47 ☺	470-15
	●	2017 - 2018	47 ☺	470-17
	●	2019 - 2020	48 ☺	470-19
	●	2021 - 2022	46 ☺	470-21
AUSTRALIAN ANTARCTIC TERRITORY				
		1957 - 2022	44 ☺	471
AUSTRIA				
Previous to 1945				
Bosnia and Herzegovina		1879 - 1918	12	202
Lombardei and Venetia, Crete, Levante		1850 - 1918	21	203
Austria-Hungarian Monarchy		1850 - 1918	22	204
German-Austrian Republic		1918 - 1921	12	205
Austrian Republic		1922 - 1937	26 ☺	206
Austria during the 3rd Reich, Ostmark		1938 - 1945	19	206-38
Austria				
Complete offer*	●	1945 - 2022	356 ☺	209S
Austrian Republic		1945 - 1967	53 ☺	207
		1968 - 1974	25 ☺	208
	●	1975 - 1984	34 ☺	209
	●	1985 - 1995	42 ☺	209-85
	●	1996 - 2006	53 ☺	209-96
	●	2007 - 2011	45 ☺	209-07
	●	2012 - 2016	47 ☺	209-12
	●	2017 - 2021	47 ☺	209-17
Sheetlets				
		1988 - 2008	51 ☺	209K
		2009 - 2014	48 ☺	209K-09
		2015 - 2021	51 ☺	209K-15

* Partly in black/white. ☺ = Take advantage of our complete offers see page 112.

Country	in colour	Period	Number of Pages	
Booklets				
		2011 - 2022	25 ☺	209H-11
Self-adhesive panes				
		2005 - 2022	26 ☺	209FS
Dispenser Stamps				
	●	2017 - 2022	11	209D-17
Vending machine stamps				
		1983 - 2017	51 ☺	209AS
	●	2018 - 2022	27 ☺	209AS-18
Neutral page for 24 vending machine stamps				
			1	209ASN
Personalized Issues of the OSD				
Personalized single stamps of the OSD		2005 - 2022	18	209PM-E
Personalized sheets of the OSD		2005 - 2011	68 ☺	209PM-B
		2012 - 2014	48 ☺	209PM-B-12
		2015 - 2017	65 ☺	209PM-B-15
	●	2018 - 2019	49 ☺	209PM-B-18
	●	2020 - 2021	48 ☺	209PM-B-20
Neutral page for 12 personalized stamps in horizontal format			1	209PM1
Neutral page for 12 personalized stamps in vertical format			1	209PM2
AZERBAIJAN				
		1992 - 1997	43 ☺	258
		1998 - 2003	21	258-98
AZORES				
Postal independence		1980 - 2007	48 ☺	222
		2008 - 2022	32 ☺	222-08
Sheetlets		1989 - 2022	21	222K
Booklets		1981 - 2015	15	222H
BAHAWALPUR				
		1945 - 1949	5	509B
BANGLADESH				
		1971 - 1990	45 ☺	507
		1991 - 2000	47 ☺	507-91
		2001 - 2004	10	507-01
BELARUS				
		1992 - 2001	45 ☺	242
		2002 - 2010	52 ☺	242-02
		2011 - 2016	52 ☺	242-11
	●	2017 - 2020	49 ☺	242-17
	●	2021 - 2022	20	242-21
BELGIUM				
		1849 - 1939	47 ☺	125
		1940 - 1944	22	126
		1944 - 1956	34 ☺	127
		1957 - 1964	33 ☺	127-57
		1965 - 1971	32 ☺	127A
		1972 - 1980	42 ☺	127B
		1981 - 1989	40 ☺	127-81
		1990 - 1997	42 ☺	127-90
		1998 - 2003	48 ☺	127-98
		2004 - 2006	42 ☺	127-04
		2007 - 2009	44 ☺	127-07
		2010 - 2014	52 ☺	127-10
		2015 - 2017	42 ☺	127-15
	●	2018 - 2020	42 ☺	127-18
	●	2021 - 2022	27 ☺	127-21
Official-Registered, Postage due, Parcel Post, Military and Railway Parcel stamps plus Booklets		1940 - 2001	46 ☺	126R
Parcel Post and Railway Parcel stamps plus Booklets		2002 - 2015	51 ☺	126R-02
Booklets	●	2016 - 2022	8	126R-16
BOPHUTHATSWANA				
		1977 - 1994	32 ☺	518

Country	in colour	Period	Number of Pages	
BOSNIA-HERZEGOVINA				
		1993 - 2008	56 ☺	173
		2009 - 2015	22	173-09
BRAZIL				
		1942 - 1967	53 ☺	479
		1967 - 1974	40 ☺	480
		1975 - 1981	39 ☺	480-75
		1982 - 1986	38 ☺	480-82
		1987 - 1993	44 ☺	480-87
		1994 - 2000	46 ☺	480-94
		2001 - 2007	41 ☺	480-01
BRITISH ANTARCTIC TERRITORIES				
		1963 - 2008	51 ☺	405
		2009 - 2022	38 ☺	405-09
BULGARIA				
		1945 - 1955	47 ☺	135
		1956 - 1962	41 ☺	135-56
		1963 - 1966	37 ☺	135-63
		1967 - 1970	40 ☺	135-67
		1971 - 1975	51 ☺	136A
		1976 - 1979	51 ☺	136-76
		1980 - 1983	51 ☺	136-80
		1984 - 1986	43 ☺	136-84
		1987 - 1990	45 ☺	136-87
		1991 - 1997	52 ☺	136-91
		1998 - 2006	52 ☺	136-98
		2007 - 2008	13	136-07
CANADA				
		1851 - 1952	27 ☺	500
		1953 - 1971	17	500-53
		1972 - 1982	37 ☺	500A
		1983 - 1991	43 ☺	500-83
		1992 - 1997	45 ☺	500-92
		1998 - 2002	49 ☺	500-98
		2003 - 2008	52 ☺	500-03
		2009 - 2012	54 ☺	500-09
		2013 - 2015	51 ☺	500-13
		● 2016 - 2018	47 ☺	500-16
		● 2019 - 2022	38 ☺	500-19
CHILE				
		1960 - 1985	43 ☺	505
		1986 - 1991	39 ☺	505-86
		1992 - 1998	44 ☺	505-92
		1999 - 2001	19	505-99
CHINA - TAIWAN (FORMOSA)				
		1945 - 1960	37 ☺	164-45
		1960 - 1969	39 ☺	164-60
		1970 - 1975	36 ☺	164-70
		1976 - 1981	38 ☺	164-76
		1982 - 1988	45 ☺	164-82
		1989 - 1994	47 ☺	164-89
		1995 - 2000	44 ☺	164-95
		2001 - 2006	61 ☺	164-01
		2007 - 2008	19	164-07

Country	in colour	Period	Number of Pages	
CHINA, PEOPLE'S REPUBLIC				
		1949 - 1959	50 ☺	159
		1960 - 1965	47 ☺	159-60
		1966 - 1976	42 ☺	159-66
		1977 - 1980	44 ☺	159-77
		1981 - 1986	55 ☺	159-81
		1987 - 1991	45 ☺	159-87
		1992 - 1996	47 ☺	159-92
		1997 - 2000	41 ☺	159-97
		2001 - 2004	44 ☺	159-01
		2005 - 2008	50 ☺	159-05
		2009 - 2011	46 ☺	159-09
		2012 - 2014	49 ☺	159-12
		2015 - 2017	48 ☺	159-15
		● 2018 - 2020	48 ☺	159-18
		● 2021 - 2022	30 ☺	159-21
CHRISTMAS ISLANDS				
		1958 - 1996	46 ☺	474
		1997 - 2016	50 ☺	474-97
		● 2017 - 2022	23	474-17
CISKEI				
		1981 - 1994	30 ☺	524
COCOS (KEELING) ISLANDS				
		1963 - 2012	50 ☺	475
		2013 - 2022	15	475-13
COMORO ISLANDS				
		1950 - 1975	17	130C
CROATIA				
		1941 - 1945	25 ☺	168-41
Republic		1991 - 2002	45 ☺	168
		2003 - 2012	47 ☺	168-03
		2013 - 2019	51 ☺	168-13
		● 2020 - 2022	20	168-20
Sheetlets		1943 - 1945	20	168K-43
		1993 - 2007	48 ☺	168K
		2008 - 2011	45 ☺	168K-08
		2012 - 2014	44 ☺	168K-12
		2015 - 2017	49 ☺	168K-15
		● 2018 - 2019	43 ☺	168K-18
		● 2020 - 2021	42 ☺	168K-20
Obligatory Tax stamps - dentated		1991 - 2008	11	168ZA
Postal tax stamps - perforated issues - sheetlets		1994	2	168ZAK
CROATIAN REPUBLIC/HERCEG-BOSNA BOSNIA-HERZEGOVINA				
		1993 - 2014	51 ☺	168BH
		2015 - 2022	26 ☺	168BH-15
CURAÇAO				
		1873 - 1949	22	429
CYPRUS				
		1880 - 1955	11	294
		1960 - 1971	20	295
		1972 - 1984	28 ☺	295A
		1985 - 2003	46 ☺	295-85
		2004 - 2019	48 ☺	295-04
		● 2020 - 2022	8	295-20
Turkish Cypriot Post		1974 - 1996	48 ☺	298
		1997 - 2018	48 ☺	298-97
		● 2019 - 2022	5	298-19
CZECH REPUBLIC				
		1993 - 2004	48 ☺	312-93
		2005 - 2013	49 ☺	312-05
		2014 - 2019	49 ☺	312-14
		● 2020 - 2022	28 ☺	312-20

Country	in colour	Period	Number of Pages	
CZECHOSLOVAKIA				
		1918 - 1939	40 ☺	309
		1945 - 1952	37 ☺	310
		1953 - 1959	40 ☺	310-53
		1960 - 1964	34 ☺	310-60
		1965 - 1967	27 ☺	311
		1968 - 1971	32 ☺	312
		1972 - 1979	57 ☺	312A
		1980 - 1984	37 ☺	312-80
		1985 - 1989	44 ☺	312-85
		1990 - 1992	12	312-90
DENMARK				
With Slesvig, Thule, Dan. West India		1851 - 1959	35 ☺	128
		1960 - 1971	15	128-60
		1972 - 1990	43 ☺	128A
		1991 - 2006	49 ☺	128-91
		2007 - 2016	48 ☺	128-07
	●	2017 - 2022	14	128-17
13 vending machine stamps with 9 showing no values			1	128AS
Special pages Booklets		2011 - 2015	5	128S
EGYPT				
		1971 - 1981	40 ☺	153A-71
		1982 - 1991	45 ☺	153A-82
		1992 - 2002	47 ☺	153A-92
		2003 - 2008	27 ☺	153A-03
ESTONIA				
		1991 - 2009	49 ☺	175
		2010 - 2021	47 ☺	175-10
EUROPE SPECIAL TERRITORIES				
Europe CEPT				
		1956 - 1971	39 ☺	290A
		1972 - 1980	49 ☺	290A-72
		1981 - 1984	37 ☺	290A-81
		1985 - 1989	51 ☺	290A-85
		1990 - 1992	36 ☺	290A-90
Europe CEPT Joint Issues of EU Countries				
		1993 - 1999	49 ☺	290A-93
		2000 - 2006	42 ☺	290A-00
		2007 - 2011	50 ☺	290A-07
		2012 - 2015	46 ☺	290A-12
	●	2016 - 2019	48 ☺	290A-16
	●	2020 - 2022	37 ☺	290A-20
Europe CEPT Sympathy Issues of non-EU Countries				
		1993 - 2000	43 ☺	290S-93
		2001 - 2010	49 ☺	290S-01
		2011 - 2019	50 ☺	290S-11
	●	2020 - 2022	24	290S-20
Europe CEPT Issues of the former Yugoslavia				
	●	1993 - 2022	41 ☺	290JS
Other Europe Issues and NORDEN				
		1990 - 1992	12	290M
		1993 - 2005	51 ☺	290M-93
		2006 - 2015	45 ☺	290M-06
	●	2016 - 2022	19	290M-16
European Year of Nature Protection				
		1995	6	280
FALKLAND-ISLANDS AND DEPENDENCIES (SOUTH GEORGIA AND SOUTH SANDWICH ISLANDS)				
		1953 - 1981	32 ☺	410
		1982 - 1991	41 ☺	410-82
		1992 - 2000	46 ☺	410-92
		2001 - 2009	48 ☺	410-01
		2010 - 2016	51 ☺	410-10
	●	2017 - 2022	34 ☺	410-17

Country	in colour	Period	Number of Pages	
FAROE ISLANDS				
		1975 - 2001	45 ☺	128F
		2002 - 2015	45 ☺	128F-02
	●	2016 - 2022	30 ☺	128F-16
Booklets		1983 - 2022	41 ☺	128FH
FINLAND				
		1856 - 1962	41 ☺	129
		1963 - 1981	30 ☺	129-63
		1982 - 1995	46 ☺	129-82
		1996 - 2007	45 ☺	129-96
		2008 - 2014	49 ☺	129-08
		2015 - 2022	54 ☺	129-15
Booklets		1988 - 2013	46 ☺	129H-88
		2014 - 2015	9	129H-14
FRANCE				
Complete Offer*	●	1849 - 2022	700 ☺	1300C
		1849 - 1940	47 ☺	130
		1940 - 1944	17	131-40
		1945 - 1959	48 ☺	131-45
		1960 - 1971	43 ☺	132
		1972 - 1976	24	132A
	●	1977 - 1983	38 ☺	132-77
	●	1984 - 1989	35 ☺	132-84
	●	1990 - 1997	46 ☺	132-90
	●	1998 - 2002	48 ☺	132-98
	●	2003 - 2005	38 ☺	132-03
	●	2006 - 2008	50 ☺	132-06
	●	2009 - 2011	48 ☺	132-09
	●	2012 - 2013	37 ☺	132-12
	●	2014 - 2015	39 ☺	132-14
	●	2016 - 2017	40 ☺	132-16
	●	2018 - 2019	38 ☺	132-18
	●	2020 - 2021	42 ☺	132-20
Special pages for adhesive stamps	●	2008	2	132-06SA
	●	2009 - 2011	6	132-09SA
	●	2012 - 2013	2	132-12SA
	●	2014 - 2015	2	132-14SA
	●	2016 - 2017	2	132-16SA
	●	2018 - 2019	2	132-18SA
	●	2020 - 2021	2	132-20SA
Council of Europe - Official stamps		1958 - 2016	6	132RE
UNESCO - Official stamps		1961 - 2016	6	132RU
Souvenir blocks	●	2006 - 2008	15	132-06B
	●	2009 - 2011	16	132-09B
	●	2012 - 2013	12	132-12B
	●	2014 - 2015	14	132-14B
	●	2016 - 2017	16	132-16B
	●	2018 - 2019	14	132-18B
	●	2020 - 2021	13	132-20B
Blocs	●	2014	2	132-14BS
	●	2016 - 2017	5	132-16BS
	●	2018 - 2019	5	132-18BS
	●	2020 - 2021	5	132-20BS
Sheetlets	●	1999 - 2002	8	132-98K
	●	2003 - 2005	8	132-03K
	●	2006 - 2008	11	132-06K
	●	2009 - 2011	8	132-09K
	●	2012 - 2013	3	132-12K
	●	2014 - 2015	5	132-14K
	●	2016 - 2017	4	132-16K
	●	2018 - 2019	6	132-18K
	●	2020 - 2021	8	132-20K
Booklets		1952 - 2009	61 ☺	132H
		2010 - 2022	15	132H-10
Blocs (CNEP)		1966 - 2022	41 ☺	132CNEP
Single Stamps "Marianne Gold star"	●	2012	3	132-12M

Country	in colour	Period	Number of Pages	
FRENCH ANTARCTIC TERRITORIES				
		1955 - 1997	46 ☺	440
		1998 - 2012	52 ☺	440-98
		2013 - 2020	47 ☺	440-13
	●	2021 - 2022	14	440-21
FRENCH POLYNESIA				
		1958 - 1983	44 ☺	442
		1984 - 1994	45 ☺	442-84
		1995 - 2009	50 ☺	442-95
		2010 - 2021	49 ☺	442-10
GEORGIA				
		1993 - 2002	44 ☺	256
GERMANY				
German States without Bavaria and Wuerttemberg		1850 - 1879	34 ☺	107
Memel		1920 - 1939	14	108
Danzig		1920 - 1939	32 ☺	109
Bavaria		1849 - 1920	20	110
Wuerttemberg		1851 - 1923	11	111
Germany		1872 - 1923	26 ☺	112
		1923 - 1933	12	115
		1933 - 1945	43 ☺	116
Joint prints		1933 - 1941	40 ☺	116Z
Occupied Territories: Bohemia and Moravia		1939 - 1945	10	117A
Occupied Territories: Alsace, Lorraine, Luxembourg		1940 - 1941	4	117B
Occupied Territories: German East Post, Generalgovernment, Estonia, Lithuania, Latvia, Eastland, Ukraine		1939 - 1944	14	117C
Occupied Territories: Channel Islands		1940 - 1943	3	117D
Occupied Territories: Albania, Kotor, Laibach, Macedonia, Montenegro, Zante, Zara		1943 - 1945	11	117E
Occupied Territories: Serbia		1941 - 1943	11	117F
German Colonies and Offices abroad		1897 - 1919	22	113
Plebiscite Issues		1920 - 1922	12	114A
German Occupation Issues WW 1914-1918 and Belgian Occupied Territory 1919-1921		1914 - 1921	10	114B
Germany 1945-1949		1946 - 1948	7	118A
Joint Issues for the American, British and Sovjet Occupied Territory		1945 - 1949	12	118B
French occupied Territories		1945 - 1949	18	118C
Sovjet occupied territories		1945 - 1949	22	118D
Obligatory Tax Stamps		1948 - 1955	1	118XV-I
AM Post Special		1945 - 1946	9	118S
Local Issues		1945 - 1946	45 ☺	119
Germany / Federal Republic		1949 - 2022	422 ☺	120B
Complete Offer*	●	1949 - 1959	17	120B-49
		1960 - 1969	30 ☺	120B-60
	●	1970 - 1979	48 ☺	120B-70
	●	1980 - 1989	44 ☺	120B-80
	●	1990 - 1994	41 ☺	120B-90
	●	1995 - 1999	44 ☺	120B-95
	●	2000 - 2004	46 ☺	120B-00
	●	2005 - 2009	41 ☺	120B-05
	●	2010 - 2014	38 ☺	120B-10
	●	2015 - 2019	44 ☺	120B-15
	●	2020 - 2022	29 ☺	120B-20

Country	in colour	Period	Number of Pages	
Vending machine stamps				
24 Vending Machine Stamps without values: emblem of the German Post Office			1	120BAS1
24 Vending Machine Stamps: Castle Sanssouci, Potsdam			1	120BAS2
24 Vending Machine Stamps without value: Postal emblem	●		1	120BAS3
24 Vending Machine Stamps without value: Postal emblem (€)	●		1	120BAS4
24 Vending Machine Stamps without values: mailboxes	●		1	120BAS5
24 Vending Machine Stamps without values: Brandenburger Gate, Berlin	●		1	120BAS6
24 Vending Machine Stamps without values: Post Tower, Bonn	●		1	120BAS7
24 Vending Machine Stamps without values: write letters	●		1	120BAS8
24 Vending Machine Stamps without values: receive letters	●		1	120BAS9
Commemorative pages				
		1989 - 2004	51 ☺	120B-EB
		2005 - 2012	51 ☺	120B-EB-05
		2013 - 2018	48 ☺	120B-EB-13
	●	2019 - 2022	32 ☺	120B-EB-19
Stationery				
Letter stationery		1998 - 2008	55 ☺	120B-BG
		2009 - 2015	56 ☺	120B-BG-09
	●	2016 - 2022	44 ☺	120B-BG-16
Philatelic Letter Stationery		1998 - 2016	49 ☺	120B-PG
	●	2017 - 2022	10	120B-PG-17
Postcards		1997 - 2016	47 ☺	120B-PK
	●	2017 - 2022	5	120B-PK-17
Special Postcards with philatelic exhibitions		1949 - 2011	50 ☺	120B-SK
Definitive stamps				
		1951 - 2022	27 ☺	120B-D
Plate errors and other specialities				
		1987 - 1989	25 ☺	120BF
		1990 - 1991	45 ☺	120BF-90
		1992 - 1993	53 ☺	120BF-92
		1994 - 1995	54 ☺	120BF-94
		1996 - 1997	35 ☺	120BF-96
Self-adhesive panes				
		2008 - 2015	48 ☺	120B-FS
	●	2016 - 2020	46 ☺	120B-FS-16
	●	2021 - 2022	17	120B-FS-21
Booklets				
		1951 - 2013	48 ☺	120B-H
		2014 - 2022	23	120B-H-14
Booklets for the German Sports Aid				
		1979 - 2011	50 ☺	120B-SH
		2012 - 2022	18	120B-SH-12
Combinations				
		1951 - 1994	45 ☺	120BZ
		1996 - 2007	16	120BZ-96
		2008 - 2022	14	120BZ-08
Pairs from sheets				
		1951 - 2019	19	120B-P
Sheets of 10 stamps				
		1979 - 1988	46 ☺	120BK
		1989 - 1991	59 ☺	120BK-89
		1992 - 1994	69 ☺	120BK-92
		1994 - 1995	54 ☺	120BK-94
		1996	42 ☺	120BK-96
		1997	37 ☺	120BK-97
		1998	38 ☺	120BK-98
		1999	34 ☺	120BK-99
		2000	52 ☺	120BK-00
		2001	48 ☺	120BK-01
		2002	49 ☺	120BK-02
		2003	46 ☺	120BK-03

Country	in colour	Period	Number of Pages	
GERMANY				
		2004	43 ☺	120BK-04
		2005	46 ☺	120BK-05
		2006	50 ☺	120BK-06
		2007	39 ☺	120BK-07
		2008	43 ☺	120BK-08
		2009	37 ☺	120BK-09
		2010	44 ☺	120BK-10
		2011	45 ☺	120BK-11
		2012	46 ☺	120BK-12
		2013	44 ☺	120BK-13
		2014	42 ☺	120BK-14
		2015	42 ☺	120BK-15
		2016	42 ☺	120BK-16
	●	2017	46 ☺	120BK-17
	●	2018	45 ☺	120BK-18
	●	2019	50 ☺	120BK-19
	●	2020	43 ☺	120BK-20
	●	2021	43 ☺	120BK-21
	●	2022	59 ☺	120BK-22
West Germany / West Berlin				
Special prints for the German Sports Aid		1976 - 1995	49 ☺	120S
Special prints for the German Sports Aid		1996 - 2022	49 ☺	120S-96
Berlin				
Complete Offer*	●	1948 - 1990	89 ☺	120C
		1948 - 1959	14	120C-48
		1960 - 1969	16	120C-60
	●	1970 - 1979	30 ☺	120C-70
	●	1980 - 1990	29 ☺	120C-80
15 Vending Machine Stamps without values			1	120CAS
Booklets		1949 - 1989	5	120C-H
Booklets for the "German Sports Aid"		1979 - 1990	4	120C-SH
Joint prints		1949 - 1989	20	120CZ
Sheet pairs		1949 - 1990	8	120C-P
Sheetlets		1979 - 1988	48 ☺	120CK
		1989 - 1990	24	120CK-89
East Germany GDR				
Complete Offer		1949 - 1990	323 ☺	121
		1949 - 1962	54 ☺	121A
		1963 - 1968	58 ☺	121B
		1969 - 1974	63 ☺	121C
		1975 - 1979	49 ☺	121D
		1980 - 1984	47 ☺	121-80
		1985 - 1990	52 ☺	121-85
Paper differences		1989 - 1990	1	121S
Booklet panes, official stamps and parcel post labels		1954 - 1988	19	121R
Booklets		1955 - 1988	4	121MH
Booklets (Booklet cover variations)		1971 - 1990	18	121HD
Joint prints		1955 - 1969	44 ☺	121Z
		1969 - 1979	57 ☺	121Z-69
		1980 - 1984	37 ☺	121Z-80
		1985 - 1990	60 ☺	121Z-85
Sheetlets		1977 - 1990	14	121K
Joint print sheetlets		1978 - 1990	16	121ZB
Special Postcards		1985 - 1990	7	121SK
Special envelopes		1984 - 1990	7	121SU
DDR/German Post (July until October 1990)	●	1990	2	121DP
DDR/German Post booklets		1990	1	121DP-H
DDR/German Post joint prints		1990	1	121DP-Z
DDR/German Post sheetlet pages		1990	1	121DP-R
Saar I				
		1920 - 1934	17	245
Saar II				
		1947 - 1959	21	246

* Partly in black/white. ☺ = Take advantage of our complete offers see page 112.

Country	in colour	Period	Number of Pages	
GIBRALTAR				
		1886 - 1971	23	138
		1972 - 1984	29 ☺	138A
		1985 - 1999	48 ☺	138-85
		2000 - 2007	49 ☺	138-00
		2008 - 2014	49 ☺	138-08
		2015 - 2022	49 ☺	138-15
GREAT BRITAIN				
		1840 - 1951	21	145
		1952 - 1969	35 ☺	145-52
		1970 - 1980	36 ☺	146
	●	1981 - 1989	40 ☺	146-81
	●	1990 - 1997	45 ☺	146-90
	●	1998 - 2004	47 ☺	146-98
	●	2005 - 2008	45 ☺	146-05
	●	2009 - 2012	56 ☺	146-09
	●	2013 - 2016	49 ☺	146-13
	●	2017 - 2019	46 ☺	146-17
	●	2020 - 2022	54 ☺	146-20
Booklets		1982 - 1998	44 ☺	146H-82
		1999 - 2010	50 ☺	146H-99
		2011 - 2020	53 ☺	146H-11
	●	2021 - 2022	12	146H-21
GREECE				
		1924 - 1949	27 ☺	140
		1950 - 1967	34 ☺	140-50
		1968 - 1980	43 ☺	141
		1981 - 1993	45 ☺	141-81
		1994 - 2004	49 ☺	141-94
		2005 - 2011	47 ☺	141-05
		2012 - 2016	51 ☺	141-12
	●	2017 - 2022	52 ☺	141-17
Sheetlets		1980 - 2018	49 ☺	141K
	●	2019 - 2020	4	141K-19
Booklets		1984 - 2020	19	141H
Regional Stamps Athos		2008 - 2017	21	141R
GREENLAND				
		1905 - 1999	45 ☺	128G
		2000 - 2012	46 ☺	128G-00
		2013 - 2020	48 ☺	128G-13
	●	2021 - 2022	13	128G-21
Booklets		1989 - 2022	30 ☺	128GH
GUERNSEY				
		1969 - 1985	35 ☺	145G
		1986 - 1997	42 ☺	145G-86
		1998 - 2008	47 ☺	145G-98
		2009 - 2016	48 ☺	145G-09
	●	2017 - 2022	44 ☺	145G-17
HONGKONG				
		1946 - 1986	37 ☺	160-46
		1987 - 1997	62 ☺	160-87
After repatriation to the PRC		1997 - 2002	47 ☺	160-97
		2003 - 2006	53 ☺	160-03
		2007 - 2010	42 ☺	160-07
		2011 - 2013	45 ☺	160-11
		2014 - 2016	44 ☺	160-14
	●	2017 - 2019	47 ☺	160-17
	●	2020 - 2022	54 ☺	160-20

Country	in colour	Period	Number of Pages	
HUNGARY				
		1871 - 1925	30 ☺	319
		1926 - 1944	34 ☺	319-26
		1945 - 1949	22	320
		1950 - 1957	40 ☺	320-50
		1958 - 1962	35 ☺	320-58
		1963 - 1967	58 ☺	321
		1968 - 1971	50 ☺	322
		1972 - 1975	55 ☺	322A
		1976 - 1980	48 ☺	322-76
		1981 - 1984	32 ☺	322-81
		1985 - 1989	47 ☺	322-85
		1990 - 1995	46 ☺	322-90
		1996 - 2002	43 ☺	322-96
		2003 - 2008	52 ☺	322-03
		2009 - 2013	43 ☺	322-09
		2014 - 2018	48 ☺	322-14
	●	2019 - 2022	41 ☺	322-19
ICELAND				
		1873 - 1943	19	155
		1944 - 1971	17	155-44
		1972 - 1995	40 ☺	155A
		1996 - 2010	49 ☺	155-96
		2011 - 2020	40 ☺	155-11
INDIA				
		1947 - 1973	43 ☺	158-47
		1974 - 1985	46 ☺	158-74
		1986 - 1996	46 ☺	158-86
		1997 - 2003	45 ☺	158-97
		2004 - 2007	32 ☺	158-04
INDONESIA				
		1984 - 1992	43 ☺	506
		1993 - 1998	46 ☺	506-93
		1999 - 2004	49 ☺	506-99
IRELAND				
		1922 - 1971	24	152
		1972 - 1984	30 ☺	152A
		1985 - 1995	47 ☺	152-85
		1996 - 2001	49 ☺	152-96
		2002 - 2007	47 ☺	152-02
		2008 - 2016	53 ☺	152-08
	●	2017 - 2022	39 ☺	152-17
ISLE OF MAN				
		1973 - 1985	33 ☺	145M
		1986 - 1996	46 ☺	145M-86
		1997 - 2005	49 ☺	145M-97
		2006 - 2012	53 ☺	145M-06
		2013 - 2016	44 ☺	145M-13
	●	2017 - 2021	49 ☺	145M-17

Country	in colour	Period	Number of Pages		
ISRAEL					
		without tabs	1972 - 1984	35 ☺	156A
			1985 - 2002	48 ☺	156-85
			2003 - 2005	9	156-03
		with tabs	1948 - 1959	23	157-48
			1960 - 1969	29 ☺	157-60
			1970 - 1979	47 ☺	157A
			1980 - 1989	44 ☺	157A-80
			1990 - 1999	45 ☺	157-90
			2000 - 2008	51 ☺	157-00
			2009 - 2013	47 ☺	157-09
			2014 - 2021	48 ☺	157-14
		Sheetlets	1963 - 2003	46 ☺	157K
			2004 - 2010	47 ☺	157K-04
			2011 - 2014	44 ☺	157K-11
			2015 - 2018	45 ☺	157K-15
	●		2019 - 2022	40 ☺	157K-19
		Vending machine stamps	1990 - 1998	32 ☺	157AS
		Definitive stamps, paper and phosphor variations	1965 - 1998	15	157PH
		Special pages: supplement to the page No. 1-3 out of album 157-48	1948 - 1949	5	157-48S
ITALY					
			1862 - 1945	57 ☺	148
			1943 - 1944	7	149
			1945 - 1959	32 ☺	150-45
			1960 - 1969	17	150-60
			1970 - 1980	40 ☺	151
			1981 - 1990	47 ☺	151-81
			1991 - 1998	42 ☺	151-91
			1999 - 2005	45 ☺	151-99
			2006 - 2011	51 ☺	151-06
			2012 - 2015	45 ☺	151-12
	●		2016 - 2020	55 ☺	151-16
	●		2021 - 2022	31 ☺	151-21
		Booklets	1989 - 2004	4	151H
JAPAN					
			1953 - 1960	22	162
			1961 - 1970	37 ☺	162-61
			1971 - 1980	39 ☺	163
			1981 - 1988	39 ☺	163-81
			1989 - 1991	45 ☺	163-89
			1992 - 1997	46 ☺	163-92
			1998 - 2000	50 ☺	163-98
			2001 - 2003	41 ☺	163-01
			2004 - 2006	51 ☺	163-04
			2007 - 2008	54 ☺	163-07
			2009	36 ☺	163-09
			2010	37 ☺	163-10
JERSEY					
			1969 - 1985	39 ☺	145J
			1986 - 1997	43 ☺	145J-86
			1998 - 2005	46 ☺	145J-98
			2006 - 2011	51 ☺	145J-06
			2012 - 2015	50 ☺	145J-12
	●		2016 - 2018	45 ☺	145J-16
	●		2019 - 2021	43 ☺	145J-19
KIRGHIZIA					
			1992 - 2002	41 ☺	257
KOSOVO					
		UNMIK	2000 - 2008	12	171
		Republic	2008 - 2019	47 ☺	171-08
	●		2020 - 2022	14	171-20
LATVIA					
			1991 - 2009	50 ☺	176
			2010 - 2022	50 ☺	176-10

Country	in colour	Period	Number of Pages	
LIECHTENSTEIN				
		1912 - 1959	36 ☺	178
		1960 - 1971	19	178-60
		1972 - 1984	31 ☺	178A
		1985 - 2002	45 ☺	178-85
		2003 - 2014	42 ☺	178-03
		2015 - 2022	43 ☺	178-15
Vending machine stamps		1995 - 2003	2	178AS
Sheetlets		1979 - 1980	41 ☺	179
		1981 - 1982	49 ☺	179-81
		1983 - 1984	50 ☺	179-83
		1985 - 1986	47 ☺	179-85
		1987 - 1988	41 ☺	179-87
		1989 - 1990	51 ☺	179-89
		1991 - 1992	41 ☺	179-91
		1993 - 1994	45 ☺	179-93
		1995 - 1996	39 ☺	179-95
		1997 - 1998	39 ☺	179-97
		1999 - 2000	58 ☺	179-99
		2001 - 2002	55 ☺	179-01
		2003 - 2004	53 ☺	179-03
		2005	30 ☺	179-05
LITHUANIA				
		1990 - 2005	47 ☺	177
		2006 - 2019	47 ☺	177-06
	●	2020 - 2022	9	177-20
LUXEMBOURG				
		1852 - 1944	37 ☺	180
		1945 - 1971	38 ☺	181
		1972 - 1984	29 ☺	181A
		1985 - 2003	46 ☺	181-85
		2004 - 2015	45 ☺	181-04
	●	2016 - 2022	31 ☺	181-16
24 vending machine stamps without value			1	181AS
Booklets		1986 - 2011	6	181H
MACAO				
		1884 - 1986	51 ☺	161
		1987 - 1995	44 ☺	161-87
		1996 - 1999	35 ☺	161-96
After repatriation to the PRC		1999 - 2004	49 ☺	161-99
		2005 - 2009	51 ☺	161-05
		2010 - 2014	54 ☺	161-10
		2015 - 2018	50 ☺	161-15
	●	2019 - 2021	47 ☺	161-19
Sheetlets		1985 - 1999	50 ☺	161K
Booklets		1984 - 1995	3	161H
After repatriation to the PRC sheetlets		1999 - 2004	36 ☺	161K-99
		2005	9	161K-05
After repatriation to the PRC special blocks		1998 - 1999	12	161SB
MACEDONIA				
		1992 - 2008	51 ☺	174
		2009 - 2015	26 ☺	174-09
Postal tax stamps		1991 - 2008	22	174ZA
MADAGASCAR				
		1958 - 1975	34 ☺	197
		1976 - 1987	44 ☺	197-76
		1988 - 1992	44 ☺	197-88
		1993 - 1994	40 ☺	197-93
MADEIRA				
Postal independence		1980 - 2007	50 ☺	224
		2008 - 2022	34 ☺	224-08
Sheetlets		1991 - 2022	21	224K
Booklets		1981 - 2015	16	224H

Country	in colour	Period	Number of Pages	
MALTA				
		1860 - 1971	38 ☺	184
		1972 - 1984	30 ☺	184A
		1985 - 1999	46 ☺	184-85
		2000 - 2009	52 ☺	184-00
		2010 - 2017	48 ☺	184-10
	●	2018 - 2022	27 ☺	184-18
MALTESE ORDER, SOVEREIGN				
		1966 - 1982	42 ☺	183
		1983 - 1992	45 ☺	183-83
		1993 - 2001	48 ☺	183-93
		2002 - 2009	52 ☺	183-02
		2010 - 2014	45 ☺	183-10
		2015 - 2019	58 ☺	183-15
	●	2020 - 2022	35 ☺	183-20
MARSHALL ISLANDS				
		1984 - 1992	46 ☺	515
		1993 - 1997	46 ☺	515-93
		1998 - 2001	44 ☺	515-98
		2002 - 2008	55 ☺	515-02
		2009 - 2012	51 ☺	515-09
		2013 - 2016	51 ☺	515-13
	●	2017 - 2018	42 ☺	515-17
	●	2019 - 2020	38 ☺	515-19
	●	2021	36 ☺	515-21-2021
MAYOTTE, FRENCH PROTECTORATE				
		1892 - 2011	31 ☺	130M
MEXICO				
		1982 - 1991	46 ☺	540
		1992 - 1998	43 ☺	540-92
		1999 - 2004	36 ☺	540-99
MICRONESIA				
		1984 - 1995	47 ☺	513
		1996 - 1998	34 ☺	513-96
		1999 - 2000	40 ☺	513-99
		2001 - 2002	46 ☺	513-01
		2003 - 2005	54 ☺	513-03
		2006 - 2008	31 ☺	513-06
MOLDOVA				
		1991 - 2002	46 ☺	244
		2003 - 2009	28 ☺	244-03
MONACO				
		1885 - 1945	21	185
		1946 - 1959	37 ☺	185-46
		1960 - 1971	39 ☺	186
		1972 - 1979	47 ☺	186A
		1980 - 1985	43 ☺	186-80
		1986 - 1991	42 ☺	186-86
		1992 - 1998	46 ☺	186-92
		1999 - 2008	47 ☺	186-99
		2009 - 2016	47 ☺	186-09
	●	2017 - 2022	37 ☺	186-17
Booklets		1989 - 2000	5	186H
MONTENEGRO				
		2006 - 2022	47 ☺	170
NAMIBIA				
		1990 - 2000	47 ☺	510-90
		2001 - 2014	49 ☺	510-01
		2015 - 2022	21	510-15
Special pages for blocks		1997	6	510S-90

Country	in colour	Period	Number of Pages	
NAURU				
		1916 - 1984	32 ☺	472
		1985 - 2007	51 ☺	472-85
		2008	2	472-08
NEPAL				
with official stamps 1859-1983		1881 - 1972	24	187
		1973 - 2001	48 ☺	188
		2002 - 2016	47 ☺	188-02
	●	2017 - 2021	14	188-17
NETHERLANDS				
		1852 - 1944	36 ☺	190
		1945 - 1966	33 ☺	190-45
		1967 - 1971	16	191
		1972 - 1979	26 ☺	191A
	●	1980 - 1989	34 ☺	191-80
	●	1990 - 1998	46 ☺	191-90
	●	1999 - 2004	47 ☺	191-99
	●	2005 - 2009	48 ☺	191-05
	●	2010 - 2013	54 ☺	191-10
	●	2014 - 2017	52 ☺	191-14
	●	2018 - 2021	46 ☺	191-18
14 vending machine stamps without value			1	191AS
Sheetlets		1988 - 2000	48 ☺	191K
		2001 - 2006	48 ☺	191K-01
		2007 - 2012	58 ☺	191K-07
		2013 - 2018	48 ☺	191K-13
	●	2019 - 2022	34 ☺	191K-19
Booklets		1964 - 1984	18	190H
		1985 - 2013	50 ☺	191H
		2014 - 2022	27 ☺	191H-14
Combinations		1940 - 1984	26 ☺	190Z
		1985 - 2001	35 ☺	191Z
NETHERLANDS ANTILLES				
		1949 - 1971	19	430
		1972 - 1985	42 ☺	430A
		1986 - 1999	46 ☺	430-86
		2000 - 2008	52 ☺	430-00
		2009 - 2010	15	430-09
NETHERLANDS INDIES				
		1864 - 1948	34 ☺	428
NETHERLANDS NEW GUINEA WEST NEW GUINEA "UNTEA"				
		1950 - 1962	6	432
NEW CALEDONIA				
		1953 - 1983	40 ☺	446
		1984 - 1996	44 ☺	446-84
		1997 - 2009	50 ☺	446-97
		2010 - 2022	38 ☺	446-10
NEW ZEALAND				
		1855 - 1952	30 ☺	494
		1953 - 1966	18	495-53
		1967 - 1980	42 ☺	495-67
		1981 - 1989	43 ☺	495-81
		1990 - 1994	43 ☺	495-90
		1995 - 1998	43 ☺	495-95
		1999 - 2002	48 ☺	495-99
		2003 - 2006	45 ☺	495-03
		2007 - 2010	48 ☺	495-07
		2011 - 2013	41 ☺	495-11
		2014 - 2016	45 ☺	495-14
	●	2017 - 2019	49 ☺	495-17
	●	2020 - 2022	46 ☺	495-20
NEWFOUNDLAND				
		1857 - 1949	21	501

Country	in colour	Period	Number of Pages	
NORFOLK-ISLAND				
		1947 - 1984	32 ☺	473
		1985 - 1998	43 ☺	473-85
		1999 - 2012	51 ☺	473-99
		2013 - 2022	27 ☺	473-13
NORTH KOREA				
		1996 - 1998	53 ☺	193
		1999 - 2001	51 ☺	193-99
NORWAY				
		1855 - 1941	18	195
		1942 - 1971	29 ☺	195-42
		1972 - 1985	31 ☺	195A
		1986 - 1997	43 ☺	195-86
		1998 - 2010	48 ☺	195-98
		2011 - 2022	43 ☺	195-11
Booklets		1976 - 2010	48 ☺	195H
		2011 - 2015	12	195H-11
OMAN				
		1944 - 1990	43 ☺	182
		1991 - 2010	52 ☺	182-91
		2011 - 2019	48 ☺	182-11
	●	2020 - 2022	40 ☺	182-20
PAKISTAN				
		1947 - 1975	45 ☺	509
		1976 - 1990	46 ☺	509-76
		1991 - 2002	36 ☺	509-91
PALAU				
		1983 - 1992	48 ☺	514
		1993 - 1996	51 ☺	514-93
		1997 - 1998	37 ☺	514-97
		1999 - 2000	58 ☺	514-99
		2001 - 2003	54 ☺	514-01
		2004 - 2005	44 ☺	514-04
		2006 - 2008	37 ☺	514-06
PALESTINE				
		1994 - 2013	52 ☺	504
		2014 - 2020	31 ☺	504-14
PAPUA NEW GUINEA				
		1952 - 1984	40 ☺	476
		1985 - 1999	44 ☺	476-85
		2000 - 2007	51 ☺	476-00
		2008 - 2010	54 ☺	476-08
		2011 - 2013	54 ☺	476-11
		2014 - 2017	51 ☺	476-14
	●	2018 - 2020	30 ☺	476-18
PITCAIRN ISLANDS				
		1940 - 1985	30 ☺	477
		1986 - 2003	48 ☺	477-86
		2004 - 2017	48 ☺	477-04
	●	2018 - 2022	10	477-18
POLAND				
Kingdom/Republic		1860 - 1945	34 ☺	217-18
Republic		1944 - 1952	49 ☺	217-44
People's Republic		1952 - 1959	45 ☺	217-52
		1960 - 1964	52 ☺	217-60
		1965 - 1969	45 ☺	217-65
since 25 years People's Republic		1969 - 1971	27 ☺	218-69
		1972 - 1978	60 ☺	218B
		1979 - 1984	43 ☺	218-79
		1985 - 1989	38 ☺	218-85
		1990 - 1995	45 ☺	218-90
		1996 - 2001	41 ☺	218-96
		2002 - 2008	49 ☺	218-02
		2009 - 2014	49 ☺	218-09
		2015 - 2018	52 ☺	218-15
	●	2019 - 2022	54 ☺	218-19

Country	in colour	Period	Number of Pages	
PORTUGAL				
		1853 - 1910	13	219
		1910 - 1933	31 ☺	219-10
		1934 - 1959	39 ☺	219-34
		1960 - 1977	49 ☺	220
		1978 - 1983	34 ☺	220-78
		1984 - 1989	37 ☺	220-84
		1990 - 1994	49 ☺	220-90
		1995 - 1998	46 ☺	220-95
		1999 - 2002	47 ☺	220-99
		2003 - 2005	52 ☺	220-03
		2006 - 2008	46 ☺	220-06
		2009 - 2011	47 ☺	220-09
		2012 - 2014	45 ☺	220-12
		2015 - 2017	55 ☺	220-15
		● 2018 - 2019	38 ☺	220-18
		● 2020 - 2022	42 ☺	220-20
Vending machine stamps		1981 - 1996	7	220A-81
		1997 - 2006	48 ☺	220A-97
		2007 - 2012	48 ☺	220A-07
		2013 - 2020	50 ☺	220A-13
		● 2021 - 2022	12	220A-21
Sheetlets		1979 - 2007	48 ☺	220K
		2008 - 2022	31 ☺	220K-08
Booklets		1983 - 2019	8	220H
RÉUNION				
		1949 - 1974	15	503
ROMANIA				
		1948 - 1959	59 ☺	231-48
		1960 - 1964	50 ☺	231-60
		1965 - 1970	60 ☺	231-65
		1971 - 1975	57 ☺	231A
		1976 - 1979	48 ☺	231-76
		1980 - 1984	50 ☺	231-80
		1985 - 1987	43 ☺	231-85
		1988 - 1991	42 ☺	231-88
		1992 - 1994	41 ☺	231-92
		1995 - 1999	40 ☺	231-95
		2000 - 2004	49 ☺	231-00
		2005 - 2006	45 ☺	231-05
		2007	24	231-07
ROSS DEPENDENCY				
		1957 - 2022	33 ☺	496
RUSSIA, REPUBLIC				
		1858 - 1917	14	237
		1918 - 1923	9	238
		1923 - 1934	29 ☺	238-23
		1935 - 1944	45 ☺	238-35
		1945 - 1949	57 ☺	238-45
		1950 - 1956	52 ☺	238-50
		1957 - 1960	55 ☺	238-57
		1961 - 1963	47 ☺	238-61
		1964 - 1966	55 ☺	238-64
		1967 - 1969	47 ☺	238-67
		1970 - 1973	58 ☺	239
		1974 - 1976	42 ☺	240
		1977 - 1979	47 ☺	241
		1980 - 1982	39 ☺	241-80
		1983 - 1986	52 ☺	241-83
		1987 - 1989	44 ☺	241-87
		1990 - 1991	24	241-90
Republic (Russian Federation)		1992 - 1997	45 ☺	241-92
		1998 - 2002	46 ☺	241-98
		2003 - 2006	49 ☺	241-03
		2007 - 2010	44 ☺	241-07
		2011 - 2013	52 ☺	241-11
		2014 - 2015	39 ☺	241-14
		● 2016 - 2018	53 ☺	241-16
		● 2019 - 2020	44 ☺	241-19
		● 2021 - 2022	50 ☺	241-21

Country	in colour	Period	Number of Pages	
SAN MARINO				
		1945 - 1955	24	249
		1956 - 1967	35 ☺	249-56
		1968 - 1982	34 ☺	250
		1983 - 1996	46 ☺	250-83
		1997 - 2007	54 ☺	250-97
		2008 - 2016	51 ☺	250-08
		● 2017 - 2022	32 ☺	250-17
SERB BOSNIA-HERZEGOVINA, REPUBLIC				
		1992 - 2011	51 ☺	173SBH
		2012 - 2015	13	173SBH-12
SERB KRAJINA, REPUBLIC				
		1993 - 1997	6	168SK
SERBIA				
		2006 - 2015	49 ☺	196
		● 2016 - 2021	46 ☺	196-16
SINGAPORE				
		1948 - 1986	59 ☺	498-48
		1987 - 1996	47 ☺	498
		1997 - 2002	49 ☺	498-97
		2003 - 2006	56 ☺	498-03
SLOVAKIA				
		1939 - 1945	14	308
SLOVAKIAN REPUBLIC				
		1993 - 2007	51 ☺	313
		2008 - 2018	49 ☺	313-08
		2019 - 2022	21	313-19
SLOVENIA				
		1991 - 2003	46 ☺	169
		2004 - 2011	51 ☺	169-04
		2012 - 2018	50 ☺	169-12
		● 2019 - 2022	29 ☺	169-19
Sheetlets		1992 - 2007	51 ☺	169K
		2008 - 2014	50 ☺	169K-08
		2015 - 2018	45 ☺	169K-15
		● 2019 - 2022	40 ☺	169K-19
SOUTH AFRICA				
		1910 - 1960	20	508
		1961 - 1984	40 ☺	508A
		1985 - 1996	48 ☺	508-85
		1997 - 2002	45 ☺	508-97
		2003 - 2009	44 ☺	508-03
		2010 - 2014	46 ☺	508-10
		2015 - 2021	32 ☺	508-15
SOUTH KOREA				
		1990 - 1995	34 ☺	192
SOUTHWEST AFRICA				
		1923 - 1960	17	510
		1961 - 1984	30 ☺	510A
		1985 - 1990	13	510-85

Country	in colour	Period	Number of Pages	
SPAIN				
		1850 - 1882	13	268
		1889 - 1939	49 ☺	268-89
		1936 - 1954	24	268-36
		1950 - 1959	14	269-50
		1960 - 1969	55 ☺	270
		1970 - 1975	32 ☺	271
		1976 - 1981	31 ☺	272
		1982 - 1984	14	272-82
	●	1985 - 1991	43 ☺	272-85
	●	1992 - 1997	44 ☺	272-92
	●	1998 - 2002	45 ☺	272-98
	●	2003 - 2007	48 ☺	272-03
	●	2008 - 2011	51 ☺	272-08
	●	2012 - 2014	43 ☺	272-12
	●	2015 - 2017	51 ☺	272-15
	●	2018 - 2019	38 ☺	272-18
	●	2020 - 2021	44 ☺	272-20
Booklets		1986 - 1990	2	272H
Special page: block No. 139	●	2004	1	272-03226A
Special page: 150 years Spanish stamps		2000	4	272-98S
Special page: definitive stamps "King Juan Carlos I." on phosphorescent paper		1982 - 1987	1	272-S1
Special page: definitive stamps "King Juan Carlos I." on phosphorescent paper		1988 - 1990	1	272-S2
Special page: sheetlet foundation 25 years Prince of Asturias (MICHEL No. 4079)	●	2005	1	272-03234A
ST. PIERRE AND MIQUELON				
		1885 - 1951	26 ☺	448A
		1952 - 1976	16	448-52
		1985 - 2007	50 ☺	448
		2008 - 2021	50 ☺	448-08
SWEDEN				
		1855 - 1945	34 ☺	252
		1946 - 1963	24	252-46
		1964 - 1971	31 ☺	253
		1972 - 1980	43 ☺	254
		1981 - 1990	43 ☺	254-81
		1991 - 2000	46 ☺	254-91
		2001 - 2010	47 ☺	254-01
		2011 - 2019	45 ☺	254-11
	●	2020 - 2022	15	254-20
Booklets		1964 - 1971	12	253P
		1972 - 1980	21	254P
		1981 - 1994	45 ☺	254P-81
		1995 - 2006	51 ☺	254P-95
		2007 - 2019	51 ☺	254P-07
	●	2020 - 2022	10	254P-20
SWITZERLAND				
Complete Offer*	●	1843 - 2022	335 ☺	260
without int. Organisations		1843 - 1937	40 ☺	259
		1938 - 1959	40 ☺	260-38
		1960 - 1967	22	260-60
		1968 - 1975	19	260A
	●	1976 - 1984	23	260-76
	●	1985 - 1998	45 ☺	260-85
	●	1999 - 2009	49 ☺	260-99
	●	2010 - 2016	46 ☺	260-10
	●	2017 - 2022	51 ☺	260-17
Blocks of Four		1960 - 1970	51 ☺	261
		1971 - 1979	46 ☺	262
		1980 - 1987	41 ☺	262-80
		1988 - 1995	44 ☺	262-88
		1996 - 2003	48 ☺	262-96
		2004 - 2009	46 ☺	262-04
		2010 - 2014	44 ☺	262-10
		2015 - 2019	48 ☺	262-15
	●	2020 - 2022	32 ☺	262-20
Int. Organisations		1922 - 2008	28 ☺	263

Country	in colour	Period	Number of Pages	
Sheetlets		1981 - 2012	48 ☺	260K
		2013 - 2020	50 ☺	260K-13
	●	2021 - 2022	50 ☺	260K-21
Booklets-Definitives and "Pro Patria"		1979 - 2018	36 ☺	260H-79
Booklets "Pro Juventute"		1980 - 2018	13	261H-80
Special page sheetlet embroidery of St. Gallen	●	2000	1	260-99S
Combinations		1968 - 2012	54 ☺	260Z-68
		2013 - 2021	31 ☺	260Z-13
SYRIA				
		1971 - 1983	40 ☺	153D
		1984 - 1989	20	153D-84
THAILAND				
		1950 - 1969	19	189-50
		1970 - 1979	37 ☺	189-70
		1980 - 1987	45 ☺	189-80
		1988 - 1991	44 ☺	189-88
		1992 - 1994	42 ☺	189-92
		1995 - 1996	37 ☺	189-95
		1997 - 1999	52 ☺	189-97
		2000 - 2002	47 ☺	189-00
		2003 - 2005	43 ☺	189-03
		2006	15	189-06
TRANSKEI				
		1976 - 1994	35 ☺	516
TURKEY				
		1920 - 1943	53 ☺	315
		1944 - 1954	37 ☺	315-44
		1955 - 1959	33 ☺	315-55
		1960 - 1970	50 ☺	315-60
		1971 - 1980	34 ☺	316
		1981 - 1991	44 ☺	316-81
		1992 - 2003	47 ☺	316-92
		2004 - 2010	49 ☺	316-04
		2011 - 2015	55 ☺	316-11
UKRAINE				
		1992 - 2001	48 ☺	243
		2002 - 2008	52 ☺	243-02
		2009 - 2014	51 ☺	243-09
		2015 - 2019	47 ☺	243-15
	●	2020 - 2022	32 ☺	243-20
UNITED ARAB EMIRATES				
		1973 - 1992	43 ☺	154-73
		1993 - 2006	48 ☺	154-93
		2007 - 2012	51 ☺	154-07
		2013 - 2021	54 ☺	154-13
UNITED NATIONS GENEVA				
		1969 - 1997	44 ☺	265
		1998 - 2012	51 ☺	265-98
		2013 - 2022	51 ☺	265-13
Sheetlets and se-tenant sheetlets		1976 - 2007	50 ☺	265K
		2008 - 2021	47 ☺	265K-08
Booklets		1995 - 2022	25 ☺	265H

Country	in colour	Period	Number of Pages	
UNITED NATIONS NEW YORK				
		1951 - 1981	42 ☺	600
		1982 - 1999	49 ☺	600-82
		2000 - 2012	53 ☺	600-00
		2013 - 2018	48 ☺	600-13
		● 2019 - 2022	24	600-19
"Flag Series" (stamps and sheets)		1980 - 1989	50 ☺	601
		1997 - 2018	19	601-97
"Flag Series" sheetlets		1980 - 1999	46 ☺	600S
		2001 - 2020	11	600S-01
"Flag Series" combinations		1980 - 2020	33 ☺	601Z
Sheetlets (without "Flag Series") and se-tenant sheetlets		1976 - 2006	51 ☺	600K
		2007 - 2013	51 ☺	600K-07
		2014 - 2021	45 ☺	600K-14
Booklets		1995 - 2022	25 ☺	600H
UNITED NATIONS VIENNA				
		1979 - 2001	47 ☺	605
		2002 - 2013	47 ☺	605-02
		2014 - 2021	48 ☺	605-14
Sheetlets and se-tenant sheetlets		1983 - 2007	48 ☺	605K
		2008 - 2018	50 ☺	605K-08
		● 2019 - 2022	19	605K-19
Booklets		1995 - 2022	25 ☺	605H
USA				
Reg. Issues, Commemoratives and Air mails		1847 - 1936	54 ☺	512
		1937 - 1968	54 ☺	512-37
		1969 - 1977	46 ☺	512-69
		1978 - 1983	37 ☺	512-78
		1984 - 1989	42 ☺	512-84
		1990 - 1994	58 ☺	512-90
		1995 - 1998	45 ☺	512-95
		1999 - 2002	45 ☺	512-99
		2003 - 2008	51 ☺	512-03
		2009 - 2014	47 ☺	512-09
		2015 - 2021	52 ☺	512-15
Officials, Postage Dues and Booklets		1879 - 1992	48 ☺	512R
Officials, Booklets and Self-adhesive Booklet Panes		1993 - 2000	46 ☺	512R-93
Booklets and self-adhesive Panes		2001 - 2008	48 ☺	512R-01
		2009 - 2022	41 ☺	512R-09
VANUATU				
		1980 - 1993	48 ☺	478
		1994 - 2005	46 ☺	478-94
		2006 - 2008	15	478-06
VATICAN				
		1929 - 1958	26 ☺	172-29
		1958 - 1963	10	172-58
		1963 - 1978	30 ☺	172-63
		1979 - 1994	46 ☺	172-79
		1995 - 2004	42 ☺	172-95
		2005 - 2015	44 ☺	172-05
		2016 - 2022	36 ☺	172-16
Vending machine stamps		2000 - 2004	2	172AS
WALLIS AND FUTUNA ISLANDS				
		1955 - 1983	31 ☺	444
		1984 - 2000	44 ☺	444-84
		2001 - 2019	51 ☺	444-01
		● 2020 - 2022	5	444-20
YUGOSLAVIA				
		1918 - 1943	34 ☺	165
		1944 - 1959	45 ☺	165-44
		1960 - 1969	44 ☺	165-60
		1970 - 1980	51 ☺	166
		1981 - 1986	40 ☺	166-81
		1987 - 1991	46 ☺	166-87
		1992 - 2001	48 ☺	166-92
		2002 - 2006	25 ☺	166-02

LINDNER DOUBLE-T ILLUSTRATED PAGES

Country	in colour	Period	Number of Pages	
AUSTRIA				
Austria				
Complete offer*		● 1945 - 2022	356 ☺	dT209S
		1945 - 1967	53 ☺	dT207
		1968 - 1974	25 ☺	dT208
		● 1975 - 1984	34 ☺	dT209
		● 1985 - 1995	42 ☺	dT209-85
		● 1996 - 2006	53 ☺	dT209-96
		● 2007 - 2011	45 ☺	dT209-07
		● 2012 - 2016	47 ☺	dT209-12
		● 2017 - 2021	47 ☺	dT209-17
Sheetlets		1988 - 2008	51 ☺	dT209K
		2009 - 2014	48 ☺	dT209K-09
		2015 - 2021	51 ☺	dT209K-15
GERMANY				
Germany / Federal Republic				
Complete Offer*		● 1949 - 2022	422 ☺	dT120B
		1949 - 1959	17	dT120B-49
		1960 - 1969	30 ☺	dT120B-60
		● 1970 - 1979	48 ☺	dT120B-70
		● 1980 - 1989	44 ☺	dT120B-80
		● 1990 - 1994	41 ☺	dT120B-90
		● 1995 - 1999	44 ☺	dT120B-95
		● 2000 - 2004	46 ☺	dT120B-00
		● 2005 - 2009	41 ☺	dT120B-05
		● 2010 - 2014	38 ☺	dT120B-10
		● 2015 - 2019	44 ☺	dT120B-15
		● 2020 - 2022	29 ☺	dT120B-20
Berlin				
Complete Offer*		● 1948 - 1990	89 ☺	dT120C
		1948 - 1959	14	dT120C-48
		1960 - 1969	16	dT120C-60
		● 1970 - 1979	30 ☺	dT120C-70
		● 1980 - 1990	29 ☺	dT120C-80
East Germany GDR				
Complete Offer		1949 - 1990	323 ☺	dT121
		1949 - 1962	54 ☺	dT121A
		1963 - 1968	58 ☺	dT121B
		1969 - 1974	63 ☺	dT121C
		1975 - 1979	49 ☺	dT121D
		1980 - 1984	47 ☺	dT121-80
		1985 - 1990	52 ☺	dT121-85
DDR/German Post (July until October 1990)		● 1990	2	dT121DP
SWITZERLAND				
without int. Organisations		1938 - 1959	40 ☺	dT260-38
		1960 - 1967	22	dT260-60
		1968 - 1975	19	dT260A
		● 1976 - 1984	23	dT260-76
		● 1985 - 1998	45 ☺	dT260-85
		● 1999 - 2009	49 ☺	dT260-99
		● 2010 - 2016	46 ☺	dT260-10
		● 2017 - 2022	51 ☺	dT260-17

A**ÅLAND ISLANDS**

2018	in colour	🇫🇮 129A-16-2018
2019	in colour	🇫🇮 129A-16-2019
2020	in colour	🇫🇮 129A-16-2020
2021	in colour	🇫🇮 129A-16-2021
2022	in colour	🇫🇮 129A-16-2022

ALDERNEY

2018		🇮🇪 145GA-12-2018
2019		🇮🇪 145GA-12-2019
2020		🇮🇪 145GA-12-2020
2021		🇮🇪 145GA-12-2021
2022		🇮🇪 145GA-12-2022

ANDORRA

French		
2018		🇲🇸 124A-08-2018
2019		🇲🇸 124A-08-2019
2020		🇲🇸 124A-08-2020
2021		🇲🇸 124A-08-2021
2022		🇲🇸 124A-08-2022

Spanish		
2018	in colour	🇲🇸 123-16-2018
2019	in colour	🇲🇸 123-16-2019
2020	in colour	🇲🇸 123-16-2020
2021	in colour	🇲🇸 123-16-2021
2022	in colour	🇲🇸 123-16-2022

ARUBA

2018		🇮🇸 431-11-2018
2019		🇮🇸 431-11-2019
2020		🇮🇸 431-11-2020
2021		🇮🇸 431-11-2021
2022		🇮🇸 431-11-2022

AUSTRALIA

2018	in colour	🇮🇸 470-17-2018
2019	in colour	🇮🇸 470-19-2019
2020	in colour	🇮🇸 470-19-2020
2021	in colour	🇮🇸 470-21-2021
2022	in colour	🇮🇸 470-21-2022

AUSTRALIAN ANTARCTIC TERRITORY

2018		🇮🇸 471-2018
2019		🇮🇸 471-2019
2020		🇮🇸 471-2020
2021		🇮🇸 471-2021
2022		🇮🇸 471-2022

AUSTRIA

2018	in colour	🇮🇸 209-17-2018
2019	in colour	🇮🇸 209-17-2019
2020	in colour	🇮🇸 209-17-2020
2021	in colour	🇮🇸 209-17-2021
2022	in colour	🇮🇸 209-22-2022

Booklets		
2018		🇮🇸 209H-11-2018
2020		🇮🇸 209H-11-2020
2022		🇮🇸 209H-11-2022

Dispenser

2018	in colour	🇮🇸 209D-17-2018
2019	in colour	🇮🇸 209D-17-2019
2020	in colour	🇮🇸 209D-17-2020
2021	in colour	🇮🇸 209D-17-2021
2022	in colour	🇮🇸 209D-17-2022

Personalized issues of the OSD

Personalized sheets of the OSD		
2018	in colour	🇮🇸 209PM-B-18-2018
2019	in colour	🇮🇸 209PM-B-18-2019
2020	in colour	🇮🇸 209PM-B-20-2020
2021	in colour	🇮🇸 209PM-B-20-2021
2022	in colour	🇮🇸 209PM-B-22-2022

Personalized single stamps of the OSD		
2018		🇮🇸 209PM-E-2018
2019		🇮🇸 209PM-E-2019
2020		🇮🇸 209PM-E-2020
2021		🇮🇸 209PM-E-2021
2022		🇮🇸 209PM-E-2022

Self-adhesive panes

2018		🇮🇸 209FS-2018
2020		🇮🇸 209FS-2020
2022		🇮🇸 209FS-2022

Sheetlets

2018		🇮🇸 209K-15-2018
2019		🇮🇸 209K-15-2019
2020		🇮🇸 209K-15-2020
2021		🇮🇸 209K-15-2021
2022	in colour	🇮🇸 209K-22-2022

Vending machine stamps

2018	in colour	🇮🇸 209AS-18-2018
2019	in colour	🇮🇸 209AS-18-2019
2020	in colour	🇮🇸 209AS-18-2020
2021	in colour	🇮🇸 209AS-18-2021
2022	in colour	🇮🇸 209AS-18-2022

AZORES

2018		🇲🇵 222-08-2018
2019		🇲🇵 222-08-2019
2020		🇲🇵 222-08-2020
2021		🇲🇵 222-08-2021
2022		🇲🇵 222-08-2022

Sheetlets

2018		🇲🇵 222K-2018
2019		🇲🇵 222K-2019
2020		🇲🇵 222K-2020
2021		🇲🇵 222K-2021
2022		🇲🇵 222K-2022

B**BELARUS**

2018	in colour	🇲🇵 242-17-2018
2019	in colour	🇲🇵 242-17-2019
2020	in colour	🇲🇵 242-17-2020
2021	in colour	🇲🇵 242-21-2021
2022	in colour	🇲🇵 242-21-2022

BELGIUM

2018	in colour	🇲🇵 127-18-2018
2019	in colour	🇲🇵 127-18-2019
2020	in colour	🇲🇵 127-18-2020
2021	in colour	🇲🇵 127-21-2021
2022	in colour	🇲🇵 127-21-2022

Booklets

2018	in colour	🇲🇵 126R-16-2018
2019	in colour	🇲🇵 126R-16-2019
2020	in colour	🇲🇵 126R-16-2020
2021	in colour	🇲🇵 126R-16-2021
2022	in colour	🇲🇵 126R-16-2022

BRITISH ANTARCTIC TERRITORIES

2018		🇮🇸 405-09-2018
2019		🇮🇸 405-09-2019
2020		🇮🇸 405-09-2020
2021		🇮🇸 405-09-2021
2022		🇮🇸 405-09-2022

C**CANADA**

2018	in colour	🇲🇵 500-16-2018
2019	in colour	🇲🇵 500-19-2019
2020	in colour	🇲🇵 500-19-2020
2021	in colour	🇲🇵 500-19-2021
2022	in colour	🇲🇵 500-19-2022

CHINA, PEOPLE'S REPUBLIC

2018	in colour	🇲🇵 159-18-2018
2019	in colour	🇲🇵 159-18-2019
2020	in colour	🇲🇵 159-18-2020
2021	in colour	🇲🇵 159-21-2021
2022	in colour	🇲🇵 159-21-2022

CHRISTMAS ISLANDS

2018	in colour	🇲🇵 474-17-2018
2019	in colour	🇲🇵 474-17-2019
2020	in colour	🇲🇵 474-17-2020
2021	in colour	🇲🇵 474-17-2021
2022	in colour	🇲🇵 474-17-2022

COCOS (KEELING) ISLANDS

2018		🇲🇵 475-13-2018
2019		🇲🇵 475-13-2019
2020		🇲🇵 475-13-2020
2021		🇲🇵 475-13-2021
2022		🇲🇵 475-13-2022

CROATIA, REPUBLIC

2018		🇲🇵 168-13-2018
2019		🇲🇵 168-13-2019
2020	in colour	🇲🇵 168-20-2020
2021	in colour	🇲🇵 168-20-2021
2022	in colour	🇲🇵 168-20-2022

Sheetlets

2018	in colour	🇲🇵 168K-18-2018
2019	in colour	🇲🇵 168K-18-2019
2020	in colour	🇲🇵 168K-20-2020
2021	in colour	🇲🇵 168K-20-2021
2022	in colour	🇲🇵 168K-22-2022

**CROATIAN REPUBLIC/HERCEG-BOSNA
BOSNIA-HERZEGOVINA**

2018		🇲🇵 168BH-15-2018
2019		🇲🇵 168BH-15-2019
2020		🇲🇵 168BH-15-2020
2021		🇲🇵 168BH-15-2021
2022		🇲🇵 168BH-15-2022

CYPRUS

2018		🇲🇵 295-04-2018
2019		🇲🇵 295-04-2019
2020	in colour	🇲🇵 295-20-2020
2021	in colour	🇲🇵 295-20-2021
2022	in colour	🇲🇵 295-20-2022

Turkish Cypriot Post

2018		🇲🇵 298-97-2018
2019	in colour	🇲🇵 298-19-2019
2020	in colour	🇲🇵 298-19-2020
2021	in colour	🇲🇵 298-19-2021
2022	in colour	🇲🇵 298-19-2022

CZECH REPUBLIC

2018		🇲🇵 312-14-2018
2019		🇲🇵 312-14-2019
2020	in colour	🇲🇵 312-20-2020
2021	in colour	🇲🇵 312-20-2021
2022	in colour	🇲🇵 312-20-2022

D**DENMARK**

2018	in colour	🇲🇵 128-17-2018
2019	in colour	🇲🇵 128-17-2019
2020	in colour	🇲🇵 128-17-2020
2021	in colour	🇲🇵 128-17-2021
2022	in colour	🇲🇵 128-17-2022

E**ESTONIA**

2018		🇲🇵 175-10-2018
2019		🇲🇵 175-10-2019
2020		🇲🇵 175-10-2020
2021		🇲🇵 175-10-2021
2022	in colour	🇲🇵 175-22-2022

EUROPE SPECIAL TERRITORIES**Europe CEPT Issues of the former Yugoslavia**

2018		🇲🇵 290JS-2018
2019		🇲🇵 290JS-2019
2020		🇲🇵 290JS-2020
2021		🇲🇵 290JS-2021
2022		🇲🇵 290JS-2022

Europe CEPT Joint Issues of EU Countries

2018	in colour	🇲🇵 290A-16-2018
2019	in colour	🇲🇵 290A-16-2019
2020	in colour	🇲🇵 290A-20-2020
2021	in colour	🇲🇵 290A-20-2021
2022	in colour	🇲🇵 290A-20-2022

Europe CEPT Sympathy Issues of non-EU Countries

2018		🇲🇵 290S-11-2018
2019		🇲🇵 290S-11-2019
2020	in colour	🇲🇵 290S-20-2020
2021	in colour	🇲🇵 290S-20-2021
2022	in colour	🇲🇵 290S-20-2022

Other Europe Issues and NORDEN

2018	in colour	🇲🇵 290M-16-2018
2019	in colour	🇲🇵 290M-16-2019
2020	in colour	🇲🇵 290M-16-2020
2021	in colour	🇲🇵 290M-16-2021
2022	in colour	🇲🇵 290M-16-2022

F**FALKLAND-ISLANDS AND DEPENDENCIES
(SOUTH GEORGIA AND SOUTH SANDWICH
ISLANDS)**

2018	in colour	🇲🇵 410-17-2018
2019	in colour	🇲🇵 410-17-2019
2020	in colour	🇲🇵 410-17-2020
2021	in colour	🇲🇵 410-17-2021
2022	in colour	🇲🇵 410-17-2022

FAROE ISLANDS

2018	in colour	🇲🇵 128F-16-2018
2019	in colour	🇲🇵 128F-16-2019
2020	in colour	🇲🇵 128F-16-2020
2021	in colour	🇲🇵 128F-16-2021
2022	in colour	🇲🇵 128F-16-2022

Booklets

2018		🇲🇵 128FH-2018
2019		🇲🇵 128FH-2019
2020		🇲🇵 128FH-2020
2021		🇲🇵 128FH-2021
2022		🇲🇵 128FH-2022

FINLAND

2018		🇲🇵 129-15-2018
2019		🇲🇵 129-15-2019
2020		🇲🇵 129-15-2020
2021		🇲🇵 129-15-2021
2022		🇲🇵 129-15-2022

FRANCE			
2018	in colour	132-18-2018	
2019	in colour	132-18-2019	
2020	in colour	132-20-2020	
2021	in colour	132-20-2021	
2022	in colour	132-22-2022	
Blocks			
2018	in colour	132-18BS-2018	
2019	in colour	132-18BS-2019	
2020	in colour	132-20BS-2020	
2021	in colour	132-20BS-2021	
2022	in colour	132-22BS-2022	
Blocs CNEP			
2018		132S48-2018	
2019		132S49-2019	
2020		132S50-2020	
2021		132S51-2021	
2022		132S52-2022	
Booklets			
2018		132H-10-2018	
2019		132H-10-2019	
2020		132H-10-2020	
2021		132H-10-2021	
2022		132H-10-2022	
Sheetlets			
2018	in colour	132-18K-2018	
2019	in colour	132-18K-2019	
2020	in colour	132-20K-2020	
2021	in colour	132-20K-2021	
2022	in colour	132-22K-2022	
Souvenir blocks			
2018	in colour	132-18B-2018	
2019	in colour	132-18B-2019	
2020	in colour	132-20B-2020	
2021	in colour	132-20B-2021	
2022	in colour	132-22B-2022	
Special pages for adhesive stamps			
2018	in colour	132-18SA-2018	
2019	in colour	132-18SA-2019	
2020	in colour	132-20SA-2020	
2021	in colour	132-20SA-2021	

FRENCH ANTARCTIC TERRITORIES (TAAF)			
2018		440-13-2018	
2019		440-13-2019	
2020		440-13-2020	
2021	in colour	440-21-2021	
2022	in colour	440-21-2022	

FRENCH POLYNESIA			
2018		442-10-2018	
2019		442-10-2019	
2020		442-10-2020	
2021		442-10-2021	
2022	in colour	442-22-2022	

G

GERMANY			
2018	in colour	120B-15-2018	
2019	in colour	120B-15-2019	
2020	in colour	120B-20-2020	
2021	in colour	120B-20-2021	
2022	in colour	120B-20-2022	

Booklets			
2018		120B-H-14-2018	
2019		120B-H-14-2019	
2020		120B-H-14-2020	
2021		120B-H-14-2021	
2022		120B-H-14-2022	

Booklets for the German Sports Aid			
2018		120B-SH-12-2018	
2019		120B-SH-12-2019	
2020		120B-SH-12-2020	
2021		120B-SH-12-2021	
2022		120B-SH-12-2022	

Combinations			
2018		120BZ-08-2018	
2019		120BZ-08-2019	
2020		120BZ-08-2020	
2021		120BZ-08-2021	
2022		120BZ-08-2022	

Commemorative pages			
2018		120B-EB-13-2018	
2019	in colour	120B-EB-19-2019	
2020	in colour	120B-EB-19-2020	
2021	in colour	120B-EB-19-2021	
2022	in colour	120B-EB-19-2022	

Definitive stamps			
2018-2019		120B-D-2019	
2020-2021		120B-D-2021	
2022		120B-D-2022	

Pairs from sheets			
2016-2018		120B-P-2018	
2019		120B-P-2019	

Self-adhesive panes			
2018	in colour	120B-FS-16-2018	
2019	in colour	120B-FS-16-2019	
2020	in colour	120B-FS-16-2020	
2021	in colour	120B-FS-21-2021	
2022	in colour	120B-FS-21-2022	

Sheets of 10 stamps			
2018	in colour	120BK-18I-2018	
2018	in colour	120BK-18II-2018	
2019	in colour	120BK-19I-2019	
2019	in colour	120BK-19II-2019	
2020	in colour	120BK-20I-2020	
2020	in colour	120BK-20II-2020	
2021	in colour	120BK-21I-2021	
2021	in colour	120BK-21II-2021	
2022	in colour	120BK-22I-2022	
2022	in colour	120BK-22II-2022	

Special prints for the German Sports Aid			
2018		120S-96-2018	
2019		120S-96-2019	
2020		120S-96-2020	
2021		120S-96-2021	
2022		120S-96-2022	

Stationery			
Philatelic Letter Stationary			
2018	in colour	120B-PG-17-2018	
2019	in colour	120B-PG-17-2019	
2020	in colour	120B-PG-17-2020	
2022	in colour	120B-PG-17-2022	

Postcards			
2019	in colour	120B-PK-17-2019	
2020	in colour	120B-PK-17-2020	
2021	in colour	120B-PK-17-2021	
2022	in colour	120B-PK-17-2022	

Stationery			
2018	in colour	120B-BG-16-2018	
2019	in colour	120B-BG-16-2019	
2020	in colour	120B-BG-16-2020	
2021	in colour	120B-BG-16-2021	
2022	in colour	120B-BG-16-2022	

GIBRALTAR			
2018		138-15-2018	
2019		138-15-2019	
2020		138-15-2020	
2021		138-15-2021	
2022		138-15-2022	

GREAT BRITAIN			
2018	in colour	146-17-2018	
2019	in colour	146-17-2019	
2020	in colour	146-20-2020	
2021	in colour	146-20-2021	
2022	in colour	146-20-2022	

Booklets			
2018		146H-11-2018	
2019		146H-11-2019	
2020		146H-11-2020	
2021	in colour	146H-21-2021	
2022	in colour	146H-21-2022	

GREECE			
2018	in colour	141-17-2018	
2019	in colour	141-17-2019	
2020	in colour	141-17-2020	
2021	in colour	141-17-2021	
2022	in colour	141-17-2022	

Booklets			
2018-2020		141H-2020	
Sheetlets			
2018		141K-2018	
2019	in colour	141K-19-2019	
2020	in colour	141K-19-2020	
2021	in colour	141K-19-2021	
2022	in colour	141K-19-2022	

GREENLAND			
2018		128G-13-2018	
2019		128G-13-2019	
2020		128G-13-2020	
2021	in colour	128G-21-2021	
2022	in colour	128G-21-2022	

Booklets			
2018		128GH-2018	
2019		128GH-2019	
2020		128GH-2020	
2021		128GH-2021	
2022		128GH-2022	

GUERNSEY			
2018	in colour	145G-17-2018	
2019	in colour	145G-17-2019	
2020	in colour	145G-17-2020	
2021	in colour	145G-17-2021	
2022	in colour	145G-17-2022	

H

HONGKONG			
2018	in colour	160-17-2018	
2019	in colour	160-17-2019	
2020	in colour	160-20-2020	
2021	in colour	160-20-2021	
2022	in colour	160-20-2022	

HUNGARY			
2018		322-14-2018	
2019	in colour	322-19-2019	
2020	in colour	322-19-2020	
2021	in colour	322-19-2021	
2022	in colour	322-19-2022	

I

ICELAND			
2018		155-11-2018	
2019		155-11-2019	
2020		155-11-2020	

IRELAND			
2018	in colour	152-17-2018	
2019	in colour	152-17-2019	
2020	in colour	152-17-2020	
2021	in colour	152-17-2021	
2022	in colour	152-17-2022	

ISLE OF MAN			
2018	in colour	145M-17-2018	
2019	in colour	145M-17-2019	
2020	in colour	145M-17-2020	
2021	in colour	145M-17-2021	
2022	in colour	145M-22-2022	

ISRAEL			
with tabs			
2018		157-14-2018	
2019		157-14-2019	
2020		157-14-2020	
2021		157-14-2021	
2022	in colour	157-22-2022	

Sheetlets			
2018		157K-15-2018	
2019	in colour	157K-19-2019	
2020	in colour	157K-19-2020	
2021	in colour	157K-19-2021	
2022	in colour	157K-19-2022	

ITALY			
2018	in colour	151-16-2018	
2019	in colour	151-16-2019	
2020	in colour	151-16-2020	
2021	in colour	151-21-2021	
2022	in colour	151-21-2022	

J

JERSEY			
2018	in colour	145J-16-2018	
2019	in colour	145J-19-2019	
2020	in colour	145J-19-2020	
2021	in colour	145J-19-2021	
2022	in colour	145J-22-2022	

K

KOSOVO, REPUBLIC			
2018		171-08-2018	
2019		171-08-2019	
2020	in colour	171-20-2020	
2021	in colour	171-20-2021	
2022	in colour	171-20-2022	

L

LATVIA			
2018		176-10-2018	
2019		176-10-2019	
2020		176-10-2020	
2021		176-10-2021	
2022		176-10-2022	

LIECHTENSTEIN			
2018		178-15-2018	
2019		178-15-2019	
2020		178-15-2020	
2021		178-15-2021	
2022		178-15-2022	

LITHUANIA			
2018			177-06-2018
2019			177-06-2019
2020	in colour		177-20-2020
2021	in colour		177-20-2021
2022	in colour		177-20-2022

LUXEMBOURG			
2018	in colour		181-16-2018
2019	in colour		181-16-2019
2020	in colour		181-16-2020
2021	in colour		181-16-2021
2022	in colour		181-16-2022
Booklets			
2013-2020			181H-2021

M

MACAO			
2018			161-15-2018
2019	in colour		161-19-2019
2020	in colour		161-19-2020
2021	in colour		161-19-2021
2022	in colour		161-22-2022

MADEIRA			
2018			224-08-2018
2019			224-08-2019
2020			224-08-2020
2021			224-08-2021
2022			224-08-2022
Sheetlets			
2018			224K-2018
2019			224K-2019
2020			224K-2020
2021			224K-2021
2022			224K-2022

MALTA			
2018	in colour		184-18-2018
2019	in colour		184-18-2019
2020	in colour		184-18-2020
2021	in colour		184-18-2021
2022	in colour		184-18-2022

MALTESE ORDER, SOVEREIGN			
2018			183-15-2018
2019			183-15-2019
2020	in colour		183-20-2020
2021	in colour		183-20-2021
2022	in colour		183-20-2022

MARSHALL ISLANDS			
2018	in colour		515-17-2018
2019	in colour		515-19-2019
2020	in colour		515-19-2020
2021	in colour		515-21-2021
2022	in colour		515-22-2022*

MONACO			
2018	in colour		186-17-2018
2019	in colour		186-17-2019
2020	in colour		186-17-2020
2021	in colour		186-17-2021
2022	in colour		186-17-2022

MONTENEGRO			
2018			170-2018
2019			170-2019
2020			170-2020
2021			170-2021
2022			170-2022

N

NAMIBIA			
2018			510-15-2018
2019			510-15-2019
2020			510-15-2020
2021			510-15-2021
2022			510-15-2022

NEPAL			
2018-2019	in colour		188-17-2019
2020	in colour		188-17-2020
2021	in colour		188-17-2021
2022	in colour		188-17-2022*

NETHERLANDS			
2018	in colour		191-18-2018
2019	in colour		191-18-2019
2020	in colour		191-18-2020
2021	in colour		191-18-2021
2022	in colour		191-22-2022

Booklets			
2018			191H-14-2018
2019			191H-14-2019
2020			191H-14-2020
2021			191H-14-2021
2022			191H-14-2022
Sheetlets			
2018			191K-13-2018
2019	in colour		191K-19-2019
2020	in colour		191K-19-2020
2021	in colour		191K-19-2021
2022	in colour		191K-19-2022

NEW CALEDONIA			
2018			446-10-2018
2019			446-10-2019
2020			446-10-2020
2021			446-10-2021
2022			446-10-2022

NEW ZEALAND			
2018	in colour		495-17-2018
2019	in colour		495-17-2019
2020	in colour		495-20-2020
2021	in colour		495-20-2021
2022	in colour		495-20-2022

NORFOLK-ISLAND			
2018			473-13-2018
2019			473-13-2019
2020			473-13-2020
2021			473-13-2021
2022			473-13-2022

NORWAY			
2018			195-11-2018
2019			195-11-2019
2020			195-11-2020
2021			195-11-2021
2022			195-11-2022

O

OMAN			
2018			182-11-2018
2019			182-11-2019
2020	in colour		182-20-2020
2021	in colour		182-20-2021
2022	in colour		182-20-2022

P

PALESTINE			
2018			504-14-2018
2019			504-14-2019
2020			504-14-2020

PAPUA NEW GUINEA			
2018	in colour		476-18-2018
2019	in colour		476-18-2019
2020	in colour		476-18-2020
2021	in colour		476-18-2021*
2022	in colour		476-18-2022*

PITCAIRN ISLANDS			
2018	in colour		477-18-2018
2019	in colour		477-18-2019
2020	in colour		477-18-2020
2021	in colour		477-18-2021
2022	in colour		477-18-2022

POLAND			
2018			218-15-2018
2019	in colour		218-19-2019
2020	in colour		218-19-2020
2021	in colour		218-19-2021
2022	in colour		218-19-2022

PORTUGAL			
2018	in colour		220-18-2018
2019	in colour		220-18-2019
2020	in colour		220-20-2020
2021	in colour		220-20-2021
2022	in colour		220-20-2022

Booklets			
2018			220H-2018
2019			220H-2019
Sheetlets			
2018			220K-08-2018
2019			220K-08-2019
2020			220K-08-2020
2021			220K-08-2021
2022			220K-08-2022
Vending machine stamps			
2018			220A-13-2018
2019			220A-13-2019
2020			220A-13-2020
2021	in colour		220A-21-2021
2022	in colour		220A-21-2022

R

ROSS DEPENDENCY			
2018			496-2018
2019			496-2019
2020			496-2020
2021			496-2021
2022			496-2022

RUSSIA, REPUBLIC			
2018	in colour		241-16-2018
2019	in colour		241-19-2019
2020	in colour		241-19-2020
2021	in colour		241-21-2021
2022	in colour		241-21-2022

S

SAN MARINO			
2018	in colour		250-17-2018
2019	in colour		250-17-2019
2020	in colour		250-17-2020
2021	in colour		250-17-2021
2022	in colour		250-17-2022

SERBIA			
2018	in colour		196-16-2018
2019	in colour		196-16-2019
2020	in colour		196-16-2020
2021	in colour		196-16-2021
2022	in colour		196-22-2022

SLOVAKIAN REPUBLIC			
2018			313-08-2018
2019	in colour		313-19-2019
2020	in colour		313-19-2020
2021	in colour		313-19-2021
2022	in colour		313-19-2022

SLOVENIA			
2018			169-12-2018
2019	in colour		169-19-2019
2020	in colour		169-19-2020
2021	in colour		169-19-2021
2022	in colour		169-19-2022

Sheetlets			
2018			169K-15-2018
2019	in colour		169K-19-2019
2020	in colour		169K-19-2020
2021	in colour		169K-19-2021
2022	in colour		169K-19-2022

SOUTH AFRICA			
2018			508-15-2018
2019			508-15-2019
2020			508-15-2020
2021			508-15-2021

SPAIN			
2018	in colour		272-18-2018
2019	in colour		272-18-2019
2020	in colour		272-20-2020
2021	in colour		272-20-2021
2022	in colour		272-22-2022

Special pages			
2018			272S-2018
2019			272S-2019
2020			272S-2020
2021			272S-2021
2022			272S-2022

ST. PIERRE AND MIQUELON

2018		448-08-2018
2019		448-08-2019
2020		448-08-2020
2021		448-08-2021
2022	in colour	448-22-2022

SWEDEN

2018		254-11-2018
2019		254-11-2019
2020	in colour	254-20-2020
2021	in colour	254-20-2021
2022	in colour	254-20-2022

Booklets		
2018		254P-07-2018
2019		254P-07-2019
2020	in colour	254P-20-2020
2021	in colour	254P-20-2021
2022	in colour	254P-20-2022

SWITZERLAND

2018	in colour	260-17-2018
2019	in colour	260-17-2019
2020	in colour	260-17-2020
2021	in colour	260-17-2021
2022	in colour	260-17-2022

Blocks of Four		
2018		262-15-2018
2019		262-15-2019
2020	in colour	262-20-2020
2021	in colour	262-20-2021
2022	in colour	262-20-2022

Booklets „Pro Juventute“		
2016-2018		261H-80-2018
2019-2021		261H-80-2021

Booklets-Definitives and „Pro Patria“		
2018		260H-79-2018
2021		260H-79-2021
2022		260H-79-2022

Combinations		
2018		260Z-13-2018
2019		260Z-13-2019
2020		260Z-13-2020
2021		260Z-13-2021

Sheetlets		
2018		260K-13-2018
2019		260K-13-2019
2020		260K-13-2020
2021	in colour	260K-21-2021
2022	in colour	260K-21-2022

U

UKRAINE

2018		243-15-2018
2019		243-15-2019
2020	in colour	243-20-2020
2021	in colour	243-20-2021
2022	in colour	243-20-2022

UNITED ARAB EMIRATES

2018		154-13-2018
2019		154-13-2019
2020		154-13-2020
2021		154-13-2021
2022	in colour	154-22-2022

UNITED NATIONS GENEVA

2018		265-13-2018
2019		265-13-2019
2020		265-13-2020
2021		265-13-2021
2022		265-13-2022

Booklets		
2018		265H-2018
2019		265H-2019
2020		265H-2020
2021		265H-2021
2022		265H-2022

Sheetlets and se-tenant sheetlets		
2018		265K-08-2018
2019		265K-08-2019
2020		265K-08-2020
2021		265K-08-2021
2022	in colour	265K-22-2022

UNITED NATIONS NEW YORK

2018		600-13-2018
2019	in colour	600-19-2019
2020	in colour	600-19-2020
2021	in colour	600-19-2021
2022	in colour	600-19-2022

„Flag Series“ Combinations		
2018		601Z-2018
2020		601Z-2020

„Flag Series“ Sheetlets		
2018		600S-01-2018
2020		600S-01-2020

„Flag Series“ stamps and sheets		
2018		601-97-2018
2020		601-97-2020

Booklets		
2018		600H-2018
2019		600H-2019
2020		600H-2020
2021		600H-2021
2022		600H-2022

Sheetlets and se-tenant sheetlets		
2018		600K-14-2018
2019		600K-14-2019
2020		600K-14-2020
2021		600K-14-2021
2022	in colour	600K-22-2022

UNITED NATIONS VIENNA

2018		605-14-2018
2019		605-14-2019
2020		605-14-2020
2021		605-14-2021
2022	in colour	605-22-2022

Booklets		
2018		605H-2018
2019		605H-2019
2020		605H-2020
2021		605H-2021
2022		605H-2022

Sheetlets and se-tenant sheetlets		
2018		605K-08-2018
2019	in colour	605K-19-2019
2020	in colour	605K-19-2020
2021	in colour	605K-19-2021
2022	in colour	605K-19-2022

USA

Booklets and self-adhesive panes		
2018		512R-09-2018
2019		512R-09-2019
2020		512R-09-2020
2021		512R-09-2021
2022		512R-09-2022

Reg. Issues, Commemoratives and Air mails		
2018		512-15-2018
2019		512-15-2019
2020		512-15-2020
2021		512-15-2021
2022	in colour	512-22-2022

V

VATICAN

2018	in colour	172-16-2018
2019	in colour	172-16-2019
2020	in colour	172-16-2020
2021	in colour	172-16-2021
2022	in colour	172-16-2022

W

WALLIS AND FUTUNA ISLANDS

2018		444-01-2018
2019		444-01-2019
2020	in colour	444-20-2020
2021	in colour	444-20-2021
2022	in colour	444-20-2022

LINDNER DOUBLE-T SUPPLEMENTS

AUSTRIA

2018	in colour	dT209-17-2018
2019	in colour	dT209-17-2019
2020	in colour	dT209-17-2020
2021	in colour	dT209-17-2021
2022	in colour	dT209-22-2022

Sheetlets		
2018		dT209K-15-2018
2019		dT209K-15-2019
2020		dT209K-15-2020
2021		dT209K-15-2021
2022	in colour	dT209K-22-2022

GERMANY

2018	in colour	dT120B-15-2018
2019	in colour	dT120B-15-2019
2020	in colour	dT120B-20-2020
2021	in colour	dT120B-20-2021
2022	in colour	dT120B-20-2022

SWITZERLAND

2018	in colour	dT260-17-2018
2019	in colour	dT260-17-2019
2020	in colour	dT260-17-2020
2021	in colour	dT260-17-2021
2022	in colour	dT260-17-2022



MICHEL
Seit über 100 Jahren

Sammeln
battenberg
giel verlag

Schweizer
Briefmarken
Katalog

Zumstein



Verlag
Nimmergut

Verlag Lothar
Bichlmaier

LITERATURE FOR COLLECTORS

OUR BESTSELLERS!



MICHEL Deutschland
€ 6002*



MICHEL Junior
€ 6003*



MICHEL Europakataloge



Die deutschen Banknoten
ab 1871
€ 952*



Euro Münzkatalog
€ 5112*



Kleiner deutscher
Münzkatalog
€ 5102*



SBK Schweiz
€ 5205*

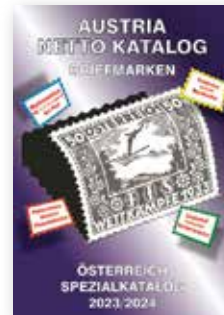

ANK Österreich Spezial
€ 946*



ZUMSTEIN Schweiz/
Liechtenstein
€ 5206*

LINDNER - our company offers a large selection of literature from many different publishers.

A bibliography can be requested free of charge.
€ 905K (in German)

*We always offer the latest editions of each catalog, which is why the order numbers and the illustrations of the catalogs change regularly. More catalogues can be found online or in the bibliography (€ 905K).



INDEX

Everything for the collector!

0-Euro Souvenir notes Albums 51, 56
2 Euro commemorative coins Coin boxes, Coin cases and albums 4-6, 26-30, 36-37, 44
5 Euro collector coins Coin boxes, Coin cases and Illustrated album 4-6, 24, 38
10 Euro collector coins with polymer ring Coin boxes, Coin cases and Illustrated album 4-6, 24-25, 39
10 Euro/20 Euro Coin boxes, Coin cases and albums 4-6, 26-30, 37, 45
18-Ring binders 72-73
20 Euro Silver coins Coin boxes, Coin cases and Illustrated album 4-6, 26-30, 37, 45

A
 Accessories for costume page design 67
 Accessories Philatelic 92-95
 Advantage offer 60, 67, 112
 ALU Showcase 100
 Aluminum Cases 18-19, 20-23
 Approval Cards 92
 Assortment box 97
 Authentic wood box 17

B
 Banknote Album 52-56, 74, 87
 Billets Touristiques 51, 56
 Blank pages 40, 65, 78, 88

C
 Caliper 49
 CARRÉE Coin capsules 17
 CARUS 16-18, 28-29, 38, 48, 103
 Cases 18-23
 Champagne lids Collection Systems 102-103
 Cleaning Cloth 110
 Cleaning machine for coins 49
 Cleaning products 50
 Coin album PUBLICA S 33, 86
 Coin albums 32-39, 42-45, 87
 Coin box BLACK SAMT for rectangular coin capsules 9
 Coin box capsules 11
 Coin box carrying case 22
 Coin box display 9
 Coin box inserts 11
 Coin boxes 4-9
 Coin capsules CARRÉE 17
 Coin capsules OCTO 16
 Coin capsules 11-13, 16-17
 Coin care products 49-50
 Coin case ALU MULTI / MULTI PLUS 19
 Coin case CARUS 16-18, 28-29, 38, 48, 103
 Coin case NERA 16-18, 24-27, 38-39, 48, 103-104
 Coin cases 24-31
 Coin cleaner 50
 Coin cleaning machine 49
 Coin collecting case 18-23
 Coin envelopes 47
 Coin gloves 49
 Coin holders 14
 Coin pages 32, 42
 Coin scales 49
 Coin suitcase 20-23, 103
 Coin tongs 49
 Coin trays 20
 Coins Illustrated albums 33-39, 44-45
 Collection box for pins/medals/emblems 97
 Collection boxes 10, 96-97, 101
 Collection case 19
 Collection/presentation boxes for swiss pocket knives 101
 Country labels 32
 Crystal clear pocket pages 64, 71

D
 d-Boxes 10
 DigiMicroscope 106
 Digital caliper 49
 Digital Magnifier 106
 Drying books 95
 dT-Blank-pages 64

E
 ECO Slipcase ring binder 73
 ERNI, Stamp care 94
 ESCHENBACH 111

Euro coin albums and accessories 33-39, 44-45
 Euro pocket books 47
 Exhibition protectors 64
 EXPO Coin case 47
 EXPO system Plexiglass 100

F
 FDC albums 83
 FIRMO Universal albums 56
 First day sheet albums 56, 83
 Flag-pages 32
 Flags 95
 Folding lamps 105
 freestyle foil sheets 66, 91

G
 Glassine envelopes 89
 Gloves 49
 Guillotine mount cutters 67, 69
 Guillotine 69

H
 Half Penny 45
 HARTBERGER® Accessories 14-15

I
 Illustrated album pages and supplements dT 123, 127
 Illustrated album pages and supplements T 112-123, 124-127
 Illustrated albums for stamps 112-127
 Indicator decals 67
 Inserts for write-ups 64
 Inserts 11

J
 Jetons Touristiques 104

K
 karat-coin albums 32-39

L
 Labeling cards 47
 Lamps 105
 Leather ring binder 33, 72
 LED Light Pad 105
 Linentester 110-111
 Little coin cases 24, 46-48

M
 Magnifiers, ESCHENBACH 111
 Magnifiers 106, 108-111
 Médailles Souvenirs 104
 Microscopes 106-107
 Mint sheet albums 95
 Mint sheet page 70
 Mounts kiloware 69
 Mounts program 68-69
 Multi collect for banknotes 54
 Multi collect for coins 41-43
 Multi collect for postcards 54-55
 Multi collect system 40-41
 Multifunctional Tester 107

N
 NERA M 16-18, 26, 38, 103-104
 NERA M PLUS 17-18, 26, 31, 103
 NERA S 17, 24, 38-39, 48
 NERA VARIUS PLUS 25
 NERA XL 16, 18, 27, 103-104
 NERA XM 17, 25, 39, 48
 NERA XS 24, 48
 NERA 24-27
 NIMBUS 16, 18-19, 98-99
 Numismatic accessories 46-50

O
 OCTO Coin capsules 16
 OMNIA Stockbook pages 70
 Optical accessories 105-111
 Other areas of collection 96-104

P
 Page Lifters 95
 Paper bags 47

Perforation gauge 93
 Pergamin Sleeves 89
 Phila-Combi-Box 93
 Photo corners 67
 PINs 25, 97
 Pocket album for banknotes 56
 Pocket album for coin holders 15
 Pocket coin album 47
 Polybag 47
 Postcard albums 74, 84-85, 87
 Presentation box made of synthetic material 97, 100
 Presentation case ALU 31
 Pressed Pennies 14, 50
 Price labels 95
 Protective covers with self-adhesive strip 57, 91
 Protective covers/sleeves for postcards, postal history, banknotes 90
 Protective foil page 70
 PUBLICA 33, 43, 54-55, 81, 84, 86-88

R
 Rectangular coin capsules 13
 Ring binder "Exclusive" 72
 Ring binder "Leather" 72
 Ring binder for LINDNER formats 72-74
 Ring binder Half penny 45
 Ring binder PUBLICA LS 55, 88
 Ring binder PUBLICA M COLOR 43, 81, 87
 Ring binder PUBLICA XL 84
 Ring binder REGULAR 72
 Ring binder RONDO REGULAR 42, 80, 83
 Ring binder STANDARD 73

S
 Scales 49
 Schildfix 9
 Slabs 18, 23
 Slip case ring binder ECO 73
 SRS Banknote album 52, 74
 SRS Postcard album 74
 SRS Ring binder 74
 SRS Stockpage album for stamps 74
 Stackable collection boxes 10, 96-97, 101
 Stamp care, ERNI 57, 94
 Stamp hangers 67
 Stamp remover 94
 Stamp tongs 49, 93
 Stampscop 93
 Stockbook pages "OMNIA" 70
 Stockbooks for stamps 76-77
 Stockpages 77, 88
 Supplementary assortment for coin boxes 9

T
 Table lamp 105
 T-Blank-Pages 60-63
 T-Blank-System for the topical collector 58-59
 T-Blank-System 60-63
 Test lamps 105
 Trays for Coin carrying case 20
 T-System introduction 58

U
 Ultrasonic cleaner 49
 UNIPLATE System for banknotes 53
 UNIPLATE System 82
 Universal album FIRMO 56
 UV detector pocket LED-magnifier 108
 UV Test lamps 107
 UV-Flashlight 107
 UV-Lamp 107

V
 Vibration cleaner 49

W
 Wood cases CARUS for coins 16-18, 28-29, 103

Z
 Zip-bags 47

LINDNER

Das Original

